

KITSAP COUNTY PUBLIC WORKS SEWER UTILITY

Bangor Keyport Force Main Replacement

February 2022

FORMAL BID CONTRACT 2022-104



Volume 1 of 2

BACK OF COVER  
THIS PAGE INTENTIONALLY LEFT BLANK

# CERTIFICATE PAGE

## Kitsap County Public Works Sewer Utility

## Bangor Keyport Force Main Replacement

The engineering material and data contained in the Plans and Specifications were prepared under the supervision and direction of the undersigned, whose seal as a registered professional engineer is affixed below.



THIS PAGE INTENTIONALLY LEFT BLANK

**KITSAP COUNTY PUBLIC WORKS SEWER UTILITY**  
**BANGOR KEYPORT FORCE MAIN REPLACEMENT**  
**VOLUME 1 OF 2**  
**TABLE OF CONTENTS**

**GENERAL**

Engineer’s Certification  
Invitation to Bid

**BID PROCEDURES AND CONDITIONS**

Bid Proposal.....  
Bid Guaranty Bond.....  
Subcontractors List.....  
Bidder Information.....  
Non-Collusion Affidavit.....  
Bidder’s Checklist.....

**CONTRACT REQUIREMENTS**

Capital Projects Contract Agreement.....  
Public Works Payment Bond .....  
Performance Bond.....

**SPECIAL PROVISIONS**

**INTRODUCTION TO THE SPECIAL PROVISIONS**

**WSDOT DIVISION 1 – SPECIAL PROVISIONS**

**1-01 DEFINITIONS AND TERMS..... 1-1**  
1-01.3 Definitions..... 1-1

**1-02 BID PROCEDURES AND CONDITIONS ..... 1-5**  
1-02.1 Bidder Responsibility ..... 1-5  
1.02.1(1) Subcontractor Responsibility..... 1-5  
1.02.1(2) Supplemental Bidder Responsibility Criteria ..... 1-5  
1.02.1(3) Documentation ..... 1-6  
1.02.1(4) Appeals ..... 1-7  
1.02.1(5) Other Conditions ..... 1-7  
1-02.2 Plans and Specifications ..... 1-8  
1-02.4(2) Subsurface Information ..... 1-8  
1-02.5 Proposal Forms ..... 1-9  
1-02.6 Preparation of Proposal..... 1-9  
1-02.7 Bid Deposit ..... 1-10  
1-02.9 Delivery of Proposal ..... 1-10  
1-02.10 Withdrawing, Revising, or Supplementing Proposal ..... 1-10  
1-02.13 Irregular Proposals ..... 1-11  
1-02.14 Disqualification of Bidders ..... 1-11  
1-02.15 Pre Award Information..... 1-12  
1-02.16 Addenda ..... 1-12

<b>1-03</b>	<b>AWARD AND EXECUTION OF CONTRACT .....</b>	<b>1-13</b>
1-03.1	Consideration of Bids .....	1-13
1-03.3	Execution of Contract .....	1-13
1-03.4	Contract Bond .....	1-14
<b>1-04</b>	<b>SCOPE OF THE WORK .....</b>	<b>1-15</b>
1-04.1(2)	Bid Items Not Included in the Proposal .....	1-15
1-04.2	Coordination of Contract Documents, Plans, Special Provisions, Specifications, and Addenda .....	1-15
1-04.3	Preconstruction Work Phase .....	1-15
1-04.3(1)	Activities .....	1-16
1-04.3(2)	Contractor's Management and Work Plan .....	1-16
1-04.3(3)	Project Safety and Accident Prevention Program .....	1-17
1-04.3(4)	COVID-19 Health and Safety Plan (CHSP) .....	1-17
1-04.3(5)	Onsite Investigations .....	1-18
1-04.3(6)	Preconstruction Photographs or Video .....	1-18
1-04.3(7)	Submittals .....	1-18
1-04.3(8)	Contractor Furnished Permits .....	1-19
1-04.3(9)	Schedules .....	1-19
1-04.3(10)	Traffic Control Plan(s) .....	1-19
1-04.3(11)	Attend EADOC Training .....	1-19
1-04.3(12)	Attend Public Meeting .....	1-19
1-04.4	Changes .....	1-20
1-04.4(2)	Work Directives .....	1-20
1-04.4(3)	Requests for Information .....	1-20
1-04.6	Variation in Estimated Quantities .....	1-20
1-04.11	Final Cleanup .....	1-21
1-04.11	Cleanup .....	1-21
1.04.11(1)	Daily Cleanup .....	1-21
1.04.11(2)	Final Cleanup .....	1-21
1-04.11(3)	Corrective Action .....	1-21
1-04.12	Temporary Facilities .....	1-22
1-04.12(1)	Space Allocation .....	1-22
1-04.12(2)	Contractor's Work Area .....	1-22
1-04.12(3)	Temporary Water for Construction and Testing .....	1-22
1-04.12(4)	Temporary Electric Power .....	1-22
1-04.12(5)	Sanitary Facilities .....	1-23
1-04.12(6)	Temporary Telephone Service .....	1-23
1-04.12(7)	Site Access and Parking .....	1-23
1-04.12(8)	Removal of Temporary Facilities .....	1-23
<b>1-05</b>	<b>CONTROL OF WORK .....</b>	<b>1-25</b>
1-05.2	Authority of Assistants and Inspectors .....	1-25
1-05.4	Conformity with and Deviations from Plans and Stakes .....	1-25
1-05.4(1)	Contracting Agency-Furnished Reference Points and Surveying .....	1-25
1-05.4(2)	Contractor-Furnished Surveying .....	1-25
1-05.4(3)	Survey Submittals .....	1-26
1-05.4(4)	Survey Records .....	1-26
1-05.4(5)	Resurveys .....	1-26
1-05.4(6)	Construction Photographs or Video .....	1-26
1-05.4(7)	Existing Markers and Monuments .....	1-27
1-05.4(8)	Re-establishment of Existing Markers and Monuments .....	1-27
1-05.5	Project Record Drawings .....	1-27
1-05.5(1)	Project Electronic Data and Information .....	1-29
1-05.7	Removal of Defective and Unauthorized Work .....	1-29

1-05.8	Coordination with Owner and Adjacent Homes .....	1-29
1-05.10	Guarantees.....	1-30
1-05.11	Facility Startup, Testing and Training.....	1-31
1-05.11(1)	Substantial Completion .....	1-32
1-05.11(2)	Operational Testing .....	1-32
1-05.11(3)	Final Inspection and Physical Completion .....	1-33
1-05.12	Final Acceptance .....	1-33
1-05.12(1)	One-Year Guarantee Period .....	1-33
1-05.13	Superintendents, Labor, and Equipment of Contractor.....	1-34
1-05.13(1)	Emergency Contact List .....	1-34
1-05.14	Cooperation with Other Contractors.....	1-34
1-05.15	Method of Serving Notices .....	1-35
<b>1-06</b>	<b>CONTROL OF MATERIALS .....</b>	<b>1-37</b>
1-06.1	Approval of Materials Prior to Use .....	1-37
1-06.1(1)	Contractor Responsibility for Submittals .....	1-38
1-06.1(2)	Limitations of Engineer’s Submittal Reviews .....	1-38
1-06.1(3)	Submittal Procedures and Requirements .....	1-39
1-06.1(4)	Submittal Variations .....	1-40
1-06.1(5)	Re-submittals .....	1-41
1-06.4	Handling and Storing Materials .....	1-41
1-06.4(1)	Pipe .....	1-41
1-06.4(2)	Equipment and Devices .....	1-42
1-06.4(3)	Delivery of Material or Equipment .....	1-42
1-06.6	Substitutions .....	1-42
1-06.7	Testing and Quality Control.....	1-45
1-06.8	Construction Quality Assurance Plan.....	1-46
<b>1-07</b>	<b>LEGAL RELATIONS AND RESPONSIBILITIES TO THE PUBLIC .....</b>	<b>1-47</b>
1-07.1	Laws to be Observed .....	1-47
1-07.2	State Sales Tax .....	1-47
1-07.2(1)	State Sales Tax – Rule 171 .....	1-47
1-07.2(2)	State Sales Tax – Rule 170 .....	1-48
1-07.2(3)	Services.....	1-48
1-07.5(3)	State Department of Ecology .....	1-48
1-07.5(5)	Noise Restrictions .....	1-48
1-07.6	Permits and Licenses.....	1-49
1-07.6(1)	Contracting Agency-Furnished Permits .....	1-49
1-07.6(2)	Contractor-Furnished Permits .....	1-49
1-07.6(3)	Business and Contracting Licenses .....	1-50
1-07.9(1)	General.....	1-50
1-07.13(1)	General.....	1-50
1-07.14	Responsibility for Damage .....	1-51
1-07.15	Temporary Water Pollution/Erosion Control .....	1-51
1-07.15(1)	Spill Prevention, Control and Countermeasures Plan.....	1-52
1-07.16(1)	Private/Public Property.....	1-52
1-07.16(2)	Vegetation Protection and Restoration .....	1-53
1-07.16(4)	Archaeological and Historical Objects.....	1-53
1-07.16(4)A	Inadvertent Discovery of Human Skeletal Remains.....	1-53
1-07.16(6)	Interfering Structures.....	1-54
1-07.17	Utilities and Similar Facilities.....	1-54
1-07.18	Insurance.....	1-56
1-07.18(1)	General Requirements .....	1-56
1-07.18(2)	Additional Insured.....	1-57
1-07.18(3)	Subcontractors .....	1-58

1-07.18(4)	Evidence of Insurance.....	1-58
1-07.18(5)	Coverage and Limits .....	1-58
1-07.18(5)A	Commercial General Liability .....	1-58
1-07.18(5)B	Automobile Liability .....	1-59
1-07.18(5)C	Workers' Compensation.....	1-59
1-07.18(5)D	Builder's Risk.....	1-59
1-07.18(5)E	Excess or Umbrella Liability .....	1-60
1-07.18(5)F	Pollution Liability.....	1-60
1-07.18(5)G	Professional Liability.....	1-61
1-07.18(5)H	LHWCA Insurance.....	1-61
1-07.18(5)I	Protection & Indemnity Insurance Including Jones Act.....	1-61
1-07.18(5)J	Hull and Machinery.....	1-61
1-07.18(5)K	Marine Pollution.....	1-62
1-07.23	Public Convenience and Safety .....	1-62
1-07.23(1)	Construction under Traffic.....	1-63
1-07.24	Rights of Way .....	1-63
1-07.28	Haul Route Restrictions.....	1-64
<b>1-08</b>	<b>PROSECUTION AND PROGRESS .....</b>	<b>1-67</b>
1-08.0	Preliminary Matters .....	1-67
1-08.0(1)	Preconstruction Public Meeting.....	1-67
1-08.0(2)	Preconstruction Conference.....	1-67
1-08.0(2)	Hours of Work .....	1-67
1-08.0(3)	Reimbursement for Overtime Work of Contracting Agency Employees .....	1-68
1-08.3	Progress Schedule .....	1-68
1-08.3(1)	General Requirements .....	1-68
1-08.3(2)A	Type A Progress Schedule .....	1-69
1-08.3(2)B	Type B Progress Schedule .....	1-69
1-08.3(2)C	Construction Sequencing and Constraints.....	1-70
1-08.3(2)E	Weekly Progress Meetings .....	1-70
1-08.3(3)	Schedule Updates .....	1-72
1-08.4	Prosecution of the Work.....	1-72
1-08.5	Time for Completion .....	1-72
1-08.8(1)	Abnormal Weather Conditions .....	1-74
1-08.9	Liquidated Damages .....	1-74
1-08.10	Termination of Contract.....	1-75
<b>1-09</b>	<b>MEASUREMENT AND PAYMENT .....</b>	<b>1-77</b>
1-09.1	Measurement of Quantities .....	1-77
1-09.2(1)	General Requirements for Weighing Equipment .....	1-77
1-09.2(7)	Bid Item Descriptions for Measurement and Payment.....	1-77
1-09.6	Force Account .....	1-92
1-09.7	Mobilization .....	1-92
1-09.9	Payments .....	1-92
1-09.9(2)	Contracting Agency's Right to Withhold and Disburse Monies Due .....	1-93
1-09.11(1)	Disputes Review Board.....	1-94
1-09.13(3)A	Administration of Arbitration .....	1-94
<b>1-10</b>	<b>TEMPORARY TRAFFIC CONTROL.....</b>	<b>1-97</b>
1-10.2(1)	General.....	1-97
1-10.2(1)A	Traffic Control Management.....	1-97
1-10.2(2)	Traffic Control Plans.....	1-97
1-10.3(2)F	Public Convenience and Safety .....	1-97
1-10.3(2)G	Construction and Maintenance of Detours.....	1-98



<b>1-11</b>	<b>OPERATION AND MAINTENANCE DATA .....</b>	<b>1-101</b>
1-11.1	Schedule of O&M Data Required.....	1-101
1-11.2	Initial Submittal .....	1-101
1-11.3	Final Submittal.....	1-102
<b>1-12</b>	<b>INTERNET-BASED PROJECT MANAGEMENT REQUIREMENTS.....</b>	<b>1-103</b>
1-12.1	Summary .....	1-103
1-12.2	Submittals.....	1-103
1-12.3	Project Communications .....	1-103
1-12.4	Access Requirements .....	1-103
1-12.5	Use Requirements.....	1-104
1-12.6	Downtime .....	1-104
1-12.7	EADOC Training.....	1-104
1-12.8	Project Management System Requirements .....	1-104
1-12.8(1)	Modifications .....	1-104
1-12.8(2)	Software, Hardware, and Internet Access.....	1-105
1-12.9	Restrictions and Limitations .....	1-105
1-12.10	Owner Responsibility.....	1-105

## **CSI SPECIFICATIONS**

---

### **CSI DIVISION 01 – GENERAL REQUIREMENTS**

- 01 12 16 Work Sequence
- 01 59 00 Temporary Sewage Bypass Systems

### **CSI DIVISION 02 – EXISTING CONDITIONS**

- 02 41 00 Demolition, Cutting, and Patching

### **CSI DIVISION 03 – CONCRETE**

- 03 60 00 Grout

### **CSI DIVISION 09 – FINISHES**

- 09 96 00 Painting and Protective Coatings

### **CSI DIVISION 22 – PIPING**

- 22 13 00 Pipe
- 22 13 10 HDPE Pipe and Fittings
- 22 13 11 Piping Systems
- 22 13 12 Ductile Iron Pipe, Fittings and Special Items
- 22 13 13 Pipe Support Systems
- 22 13 15 Valve Basic Requirements
- 22 13 19 Pipe Appurtenances

### **CSI DIVISION 31 – EARTHWORK**

- 31 10 00 Site Clearing
- 31 23 18 Rock Removal
- 31 23 19 Dewatering
- 31 23 24 Flowable Fill
- 31 23 33 Trenching, Backfilling, and Compacting for Utilities
- 31 23 43 Earthwork
- 31 25 14 Soil Erosion and Sediment Control
- 31 41 00 Excavation Support Systems

**CSI DIVISION 32 – EXTERIOR IMPROVEMENTS**

- 32 12 16 Hot Mix Asphalt (HMA) Paving
- 32 91 19 Topsoiling and Finished Grading
- 32 92 30 Grass Pavers

**CSI DIVISION 33 – UTILITIES**

- 33 05 16 Utility Structures
- 33 05 23.13 Horizontal Directional Drilling
- 33 05 23.32 Cured-In-Place Pipe
- 33 11 50 Existing Pipe Abandonment
- 33 30 10.16 TV Inspection of Sewer Pipelines

**CSI DIVISION 40 – PROCESS INTERCONNECTIONS**

- 40 05 23 Miscellaneous Valves
- 40 05 61 Gate Valves
- 40 94 23 Flow Process Measurement Devices
- 40 94 24 Pressure Sensor Rings

**APPENDICES**

---

**Appendix A – Prevailing Wage Rates**

**Appendix B – Permits**

**Appendix C – Suggested Sequencing Plan**

**Appendix D – Suggested Bypass Plans**

**Appendix E – Temporary Construction Easements**

**Appendix F – Geotechnical Report**

**DRAWINGS (BOUND SEPARATELY) – VOLUME 2 OF 2**

---

THIS PAGE INTENTIONALLY LEFT BLANK



**INVITATION TO BID  
FORMAL BID CONTRACT  
2022-104**

**KITSAP COUNTY PUBLIC WORKS WASTEWATER DIVISION**

**BANGOR-KEYPORT FORCE MAIN REPLACEMENT**

<b>BID SUBMISSION DATE &amp; TIME</b>	<b>Wednesday, March 23, 2022 @ 3:00 p.m. Purchasing Office 614 Division Street MS-7 Port Orchard, Washington 98366</b>
<b>BID OPENING TIME &amp; LOCATION</b>	<b>Wednesday, March 23, 2022 @ 3:15 Commissioners Chambers, 4<sup>th</sup> Floor Kitsap County Administration Building 619 Division Street Port Orchard, Washington 98366</b>
<b>MANDATORY PRE-BID MEETING</b>	<b>Wednesday, February 23, 2022 @ 1:00 p.m. Kitsap County Central Kitsap Wastewater Treatment Plant 12351 Brownsville Hwy NE Poulsbo, Washington 98370</b>
<b>ENGINEERS ESTIMATE:</b>	<b>\$23,200,000 - \$24,700,000</b>

The Kitsap County Board of Commissioners will receive sealed bids for the construction of the **Bangor-Keypoint Force Main Replacement** until the time and date indicated above. Bids will be received, publicly opened and read aloud at the locations described above. Instructions for the delivery of bids are contained in the Special Provisions for the Project. Prospective Bidders are hereby notified that they are solely responsible for ensuring timely delivery of their bid to the Kitsap County Purchasing Office on or before the bid submission date and time indicated above.

The principal items or elements of construction include:

*Conveyance Piping Improvements*

- Approximately 3,700 linear feet (LF) of 24-inch, diameter HDPE DR 11 sanitary sewer force main along Clear Creek Road NW, NW Mountain View Rd and within the BPA Easement area
- Approximately 800 LF of 20-inch diameter cured-in-place pipe in existing 20-inch diameter ductile iron pipe that crosses under SR 3
- Approximately 16,900 LF of 26-inch diameter HDPE DR 11 sanitary sewer force main along SR 3, SR 308, NW Luoto Court, Silverdale Way NW, NW Katy Pl and NE Tagholm Rd.
- Approximately 9,500 LF of 30-inch diameter HDPE DR 11 sanitary sewer force main along Brownsville Hwy
- Miscellaneous pipeline improvements including air vacuum valve assemblies and blow-off assemblies

- All customers currently connected to the existing alignment will be transferred to the new sanitary sewer force main with small diameter HDPE force mains connecting to the existing Individual Pumping Station (IPS)
- Miscellaneous improvements including air vacuum valve assemblies and blow-off assemblies will be installed as shown on the drawings.

#### *Pump Station 17 Improvements*

- PS 17 improvements includes a new flow meter vault and appurtenances within the existing PS 17 property

#### *Pump Station 24 Improvements*

- PS 24 Improvements include a new 96-inch diameter discharge manhole, pig launch appurtenance improvements, full replacement of the existing flow meter including electrical and control system integration, coating of the wet well, and installation of a complete wet well flushing system including all piping and appurtenances.

A mandatory pre-bid meeting will be held at the location described above. After the meeting, a tour of the sites will be conducted. This will be the only tour of the sites and facilities.

The bid will be advertised once a week for two weeks in a newspaper of general circulation in Kitsap County. A minimum of 14 calendar days will be allowed for advertising. Bids will be opened no sooner than the 15<sup>th</sup> day of advertisement.

Bid documents may be found on the Kitsap County Web site [www.kitsapgov.com/purchasing/bids.htm](http://www.kitsapgov.com/purchasing/bids.htm). Questions regarding the bid process, contract terms and conditions, or how to obtain copies of the bid documents shall be directed to Glen McNeill at 360-337-4789, or email [purchasing@co.kitsap.wa.us](mailto:purchasing@co.kitsap.wa.us). Technical questions about the work covered by the bid documents shall be directed to Floyd Bayless, Construction Manager, at (360) 337-5631 or email [fbayless@co.kitsap.wa.us](mailto:fbayless@co.kitsap.wa.us).

Kitsap County reserves the right to reject any all bids and to waive informalities or irregularities. Bids received after the time set for submission of bids will not be considered.

Each bid proposal shall be completely sealed in a separate envelope, properly addressed as stated above, with the name and address of the bidder and the name of the project plainly written on the outside of the envelope. All bids shall be accompanied by:

- County Bid Proposal – as published in Invitation to Bid
- Signed acknowledgment of receipt of all addenda
- Surety company Bid Bond on an approved form, certified check, or cashier's check payable to Kitsap County in an amount not less than five percent (5%) of the basic Bid
- Subcontractor's List
- Bidder Information
- Bidder Responsibility Checklist;
- Subcontractor Responsibility Checklist;
- Non Collusion Affidavit
- Certification of Compliance with Wage Payment Statutes

Should the successful bidder fail to enter into such contract in accordance with the Bid and furnish all documents and bonds required within the time frames stated in the specifications, the bid proposal deposit or bond shall be forfeited to Kitsap County.

**Bids are likely to be rejected if the lowest, responsible, responsive Bid received exceeds the Engineer's estimate by an unreasonable amount.**

Kitsap County hereby notifies all bidders that it will affirmatively ensure that in any contract entered into pursuant to the advertisement, Women and Minority Business Enterprises will be afforded full opportunity to submit bids in response to this invitation and will not be discriminated against on the grounds of race, color, sex, or national origin in consideration for an award. Minority Business Enterprises will be required to meet all requirements of law as related to Public Works contracts, including the provision of the Equal Employment Opportunity and Affirmative Action Plan on the basis of any other bidder. Kitsap County is an Equal Opportunity and Affirmative Action Employer.

This project will be funded in part through the Washington State Public Works Board (PWB) program with state funds. Neither the State of Washington nor any of its departments or employees are, or shall be, a party to any contract or any subcontract resulting from this solicitation for bids. All work performed on this project will be subject to state prevailing wage rates.

Bidders are hereby notified this project is funded in part by a Defense Community Infrastructure Program (DCIP) grant which requires compliance with the Buy American Act (BAA). The BAA is defined under Title 41, Chapter 83 of the United States Code (U.S.C.) and is generally described as the requirement or preference for the purchase or acquisition of goods, products, or materials produced in the United States, including iron, steel, and manufactured goods. Bidders are encouraged to review and understand the conditions, requirements and Contractor responsibilities under the BAA and the project's "Approval of Materials Prior to Use" section outlined in Special Provisions Section 1-06.1.

This set of plans was prepared under contract with Kitsap County, with financial support from the Office of Economic Adjustment, Department of Defense. The content reflects the views of Kitsap County and does not necessarily reflect the views of the Office of Economic Adjustment."

The Successful bidder will be required to conform to the wage requirements prescribed by the federal Davis-Bacon and Related Acts which requires that all laborers and mechanics employed by contractors and subcontractors performing on contracts funded in whole or in part by PWB or DCIP appropriations in excess of \$2,000 pay their laborers and mechanics not less than the prevailing wage rates and fringe benefits, and determined by the Secretary of Labor, for corresponding classes of laborers and mechanics employed on similar projects in the area. All contractors must be licensed in the State of Washington to conduct business.

Bidders are encouraged to review and understand the conditions, requirements and Contractor responsibilities of the project's "Permits and Licenses" section outlined in Special Provisions Section 1-07.6(1).

THIS PAGE INTENTIONALLY LEFT BLANK



## BID PROCEDURES AND CONDITIONS

THIS PAGE INTENTIONALLY LEFT BLANK

## BID PROPOSAL

TO: Kitsap County Board of Commissioners  
614 Division Street  
Port Orchard, WA 98366

Board of Commissioners:

The undersigned bidder agrees, if this bid is accepted, to enter into a contract with the Contracting Agency, in the form included in the specifications to perform and furnish the work as specified or indicated in the bidding documents for the bid price and within the bid times indicated in this bid and in accordance with the other terms and conditions of the contract documents.

In submitting this bid, bidder represents, as more fully set forth in the contract, that:

1. This bid will remain subject to acceptance for 60 days after the day of bid opening. The Contracting Agency retains the right to request the apparent low bidder extend the award period or adjust their price accordingly. If an adjustment is requested, the Contracting Agency reserves the right to request the same adjustment from other bidders.
2. The Contracting Agency has the right to reject this bid.
3. Bidder will sign and submit the contract with the bonds and other documents required by the bidding requirements within 10 days after the date of Contracting Agency's Notice of Award.
4. Bidder has examined copies of all the bidding documents.
5. Bidder has made sufficient examination and has investigated and is satisfied as to the conditions to be encountered, the character, quantity, quality and scope of work, the quantities and qualities of materials to be supplied and equipment and labor to be used, and the requirements of the contract and proposal submitted, including all addenda for performance of the work.
6. Bidder has visited the jobsite and is completely familiar with the existing conditions, concurrently scheduled construction, access, staging and site limitations, and has made allowances for those conditions in the their bid.
7. Bidder is familiar with all federal, state, and local laws, ordinances and regulations, which in any manner might affect those engaged or employed in the work, the materials, equipment, or procedures used in the work, or which in any other way, might affect the conduct of the work. The Bidder is assumed to be familiar with such laws and regulations, and no plea of misunderstanding or ignorance of the law will be considered.
8. Bidder has correlated the information known to bidder, information and observations obtained from visits to the site, reports and drawings identified in the bidding documents and additional examinations, investigations, explorations, tests, studies, and data with the bidding documents.
9. Bidder agrees that the work will be completed within the time period established in the Contract Document (see Section 1-08.5) from the date of Notice to Proceed.
10. The bidder has determined from careful examination the methods; materials, labor and equipment required to perform the work in full and shall reflect the same in his bid price. If, during the performance of the work, methods, materials, labor or equipment required are beyond those anticipated by the bidder, the Bidder will not be entitled to additional compensation except as may be provided for elsewhere in these specifications

It is anticipated that this project will be funded in part by the Washington State Department of Ecology. Neither the State of Washington nor any of its departments or employees are, or shall be, a party to this contract or any subcontract.

**Bidder has received the following addenda, receipt of which is hereby acknowledged:**

DATE	NUMBER
_____	_____
_____	_____
_____	_____
_____	_____

**SUMMARY OF BID DOCUMENTATION:**

It is mandatory that each bidder complete and submit with its bid, documentation required by the contract documents, including, but not limited to the following:

- 1. Bid Proposal
- 2. Bid Guarantee Bond
- 3. Subcontractor's List
- 4. Bidder Information
  - a. Bidder Responsibility Checklist
  - b. Subcontractor Responsibility Checklist
- 5. Non-collusion Affidavit Certificate
- 6. Certification of Compliance with Wage Payment Statutes

**BASIC BID:**

Pursuant to and in compliance with the advertisement for bids and other documents relating thereto, the undersigned Bidder hereby certifies having carefully examined contract documents entitled **Bangor-Keyport Force Main Replacement** as well as conditions affecting the work, and is familiar with the sites; and having made the necessary examinations, here proposes to furnish all labor, materials, equipment, and services necessary to complete the work in strict accordance with the above named documents for an amount computed upon the basis of the quantity of work actually performed at the Bid prices set forth herein.

**PROPOSAL:**

The Bidder certifies that the cost of all labor, equipment, plants, materials, including overhead and profit, necessary for proper completion of the work shall be included in the prices for the various bid items.

**NOTE: UNIT PRICES FOR ALL ITEMS, ALL EXTENSIONS, AND THE TOTAL AMOUNT OF BID MUST BE SHOWN.** All prices shall be in legible and written in ink or typed. The proposal shall include: a unit price for each item (omitting digits more than four places to the right of the decimal point); an extension for each unit price (omitting digits more than two places to the right of the decimal point); and the total contract price (the sum of all extensions). Unit prices for all numbers shall be shown in both words and figures. In case of conflict, words shall govern.

The Bidder shall bid on all alternates and/or schedules as they are fully considered in making award. If a bidder fails to bid an alternate or schedule, or if he or she notes "no bid," it will be construed as meaning that there will be no change in the contract amount and that the alternate or schedule is included in the contract amount. Descriptions for measurement and payment for the following Bid items are included in Section 1-09 of the Special Provisions.

Schedule A includes work from Pump Station 17 to the intersection of NE Tagholm Road/Brownsville Highway; Schedule B includes work from the intersection of NE Tagholm Road/Brownsville Highway to Station 277+90, as well as the improvements at PS 24.

THIS PAGE INTENTIONALLY LEFT BLANK

**Bid Schedule A – Pump Station 17 & Intersection of NE Tagholm Road/Brownsville Highway**

Item No.	Ref. Section	Est. Quantity	Unit Price (in words)	Unit Price (in Numbers)	Extended Amount (Qty x Unit Price) (in numbers)
1A	Preconstruction Work Phase	1-04	1 LS		
2A	Final Cleanup and Restoration	1-04	1 LS		
3A	Surveying	1-05	1 LS		
4A	Project Record Drawings <sup>1</sup>	1-05	1 LS		
5A	Type B Schedules	1-08	14 MO	One Thousand Dollars and No Cents	\$1,000.00
6A	Minor Change (Allowance)	1-09	1 FA	Five Hundred Twenty-Five Thousand Dollars and No Cents	\$525,000.00
7A	Mobilization and Demobilization	1-09	1 LS		
8A	Dewatering (Allowance)	Div. 31	1 FA	One Hundred Seventy Five Thousand Dollars and No Cents	\$175,000.00
9A	Excavation Support Systems	Div. 31	1 LS		
10A	Temporary Erosion and Sediment Control	Div. 31	1 FA		
11A	Project Temporary Traffic Control	1-10	1 LS		
12A	Existing Infrastructure/Utility Conflicts (Allowance)	1-09	1 FA	One Hundred Fifty Thousand Dollars and No Cents	\$150,000.00

<sup>1</sup> The lump sum for this bid item shall be at least 0.5% of the total bid amount

**Bid Schedule A – Pump Station 17 & Intersection of NE Tagholm Road/Brownsville Highway**

Item No.	Ref. Section	Est. Quantity	Unit Price (in words)	Unit Price (in Numbers)	Extended Amount (Qty x Unit Price) (in numbers)
13A 24-inch Diameter HDPE DR 11 Sewer Force Main	Div. 22	3,400 LF	_____	\$ _____	\$ _____
14A Horizontal Directional Drilled 24-inch Diameter, HDPE DR 11 Force Main	Div. 33	1 LS	_____	\$ _____	\$ _____
15A 26-inch Diameter HDPE DR 11 Sewer Force Main	Div. 22	17,000 LF	_____	\$ _____	\$ _____
16A 60-inch Diameter Manhole (BPA Easement) and Bioswale	Div. 22	1 EA	_____	\$ _____	\$ _____
17A 20-inch Diameter CIPP Sewer Force Main	Div. 22	830 LF	_____	\$ _____	\$ _____
18A 2-inch Combination Air Vacuum Valve Assembly	Div. 40	6 EA	_____	\$ _____	\$ _____
19A 3-inch Combination Air Vacuum Valve Assembly	Div. 40	5 EA	_____	\$ _____	\$ _____
20A 4-inch Blowoff Valve Assembly	Div. 40	8 EA	_____	\$ _____	\$ _____
21A IPS Sewer Lateral from ROW to Main	Div. 22	5 EA	_____	\$ _____	\$ _____
22A 26-inch Diameter HDPE DR 11 11.25 Degree Bend	Div. 22	4 EA	_____	\$ _____	\$ _____
23A 26-inch HDPE DR 11 22.5 Degree Bend	Div. 22	3 EA	_____	\$ _____	\$ _____
24A 24-inch HDPE DR 11 45 Degree Bend	Div. 22	8 EA	_____	\$ _____	\$ _____



**Bid Schedule A – Pump Station 17 & Intersection of NE Tagholm Road/Brownsville Highway**

Item No.	Ref. Section	Est. Quantity	Unit Price (in words)	Unit Price (in Numbers)	Extended Amount (Qty x Unit Price) (in numbers)
25A 26-inch Diameter HDPE DR 11 45 Degree Bend	Div. 22	8 EA	_____	\$ _____	\$ _____
26A 26-inch Diameter HDPE DR 11 Non-Standard Degree Bend	Div. 22	1 EA	_____	\$ _____	\$ _____
27A 24-inch Diameter HDPE DR 11 Flange Adapter	Div. 22	17 EA	_____	\$ _____	\$ _____
28A 26-inch Diameter HDPE DR 11 Flange Adapter	Div. 22	14 EA	_____	\$ _____	\$ _____
29A Abandon Existing Force Main	Div. 33	20,500 LF	_____	\$ _____	\$ _____
30A Pump Station 17 Improvements, Bypass, and Final Connections	1-09	1 LS	_____	\$ _____	\$ _____
31A Brownsville Highway Connection	1-09	1 LS	_____	\$ _____	\$ _____
32A CIPP Bypass	1-09	1 LS	_____	\$ _____	\$ _____
33A Connect to Existing Pump Station 64	1-09	1 LS	_____	\$ _____	\$ _____
34A CIPP Connection to New Saddle Manhole	Div. 33	1 LS	_____	\$ _____	\$ _____
35A CIPP Connection to New 26- inch HDPE DR 11 Pipe	Div. 33	1 LS	_____	\$ _____	\$ _____
36A Asphalt Removal	Div. 32	18,900 SY	_____	\$ _____	\$ _____

**Bid Schedule A – Pump Station 17 & Intersection of NE Tagholm Road/Brownsville Highway**

Item No.	Ref. Section	Est. Quantity	Unit Price (in words)	Unit Price (in Numbers)	Extended Amount (Qty x Unit Price) (in numbers)
37A Removal of Unsuitable Foundation Material (Allowance)*	1-09	350 CY	_____	\$ _____	\$ _____
38A Import Trench Foundation Material (Allowance)*	1-09	600 TN	_____	\$ _____	\$ _____
39A Trench Backfill	Div. 31	27,200 TN	_____	\$ _____	\$ _____
40A Controlled Density Fill (CDF) Encasement	Div 31	400 TN	_____	\$ _____	\$ _____
41A Crushed Surfacing Base Course (CSBC)	Div. 31	4,300 TN	_____	\$ _____	\$ _____
42A Crushed Surfacing Top Course (CSTC)	Div 31	1,100 TN	_____	\$ _____	\$ _____
43A HMA Cl. ½-inch PG 58-22 for Trench Patch	Div. 32	3,400 TN	_____	\$ _____	\$ _____
44A HMA Cl. ½-inch PG 58-22 Extended	Div. 32	1,000 TN	_____	\$ _____	\$ _____
45A General Restoration	Div. 32	25,700 SF	_____	\$ _____	\$ _____
46A ROW Restoration at NW Katy Place and NE Tagholm Rd	Div. 32	1 LS	_____	\$ _____	\$ _____
47A Grass Pavers	Div 32	800 SY	_____	\$ _____	\$ _____
48A Replace Survey Monument (Allowance)	1-09	1 EA	_____	\$ _____	\$ _____

**Bid Schedule A – Pump Station 17 & Intersection of NE Tagholm Road/Brownsville Highway**

Item No.	Ref. Section	Est. Quantity	Unit Price (in words)	Unit Price (in Numbers)	Extended Amount (Qty x Unit Price) (in numbers)
<b>Subtotal of Schedule A Bid Items</b>				\$ _____	
<b>Sales Tax @ 9%</b>				\$ _____	
<b>Total for Schedule A</b>				\$ _____	

**Bid Schedule B – Intersection of NE Tagholm Road/Brownsville Highway to Station 277+90**

Item No.	Ref. Section	Est. Quantity	Unit Price (in words)	Unit Price (in Numbers)	Extended Amount (Qty x Unit Price) (in numbers)
1B	Preconstruction Work Phase	1-04	1 LS		
2B	Final Cleanup and Restoration	1-04	1 LS		
3B	Surveying	1-05	1 LS		
4B	Project Record Drawings <sup>2</sup>	1-05	1 LS		
5B	Type B Schedules	1-08	5 MO	One Thousand Dollars and No Cents	\$1,000.00
6B	Minor Change (Allowance)	1-09	1 FA	Two Hundred Twenty Five Thousand Dollars and No Cents	\$225,000.00
7B	Mobilization and Demobilization	1-09	1 LS		
8B	Dewatering (Allowance)	Div. 31	1 FA	Fifty-Five Thousand Dollars and No Cents	\$55,000.00
9B	Excavation Support Systems	Div. 31	1 LS		
10B	Temporary Erosion and Sediment Control	Div. 31	1 FA		
11B	Project Temporary Traffic Control	1-10	1 LS		

<sup>2</sup>The lump sum for this bid item shall be at least 0.5% of the total bid amount

**Bid Schedule B – Intersection of NE Tagholm Road/Brownsville Highway to Station 277+90**

Item No.	Ref. Section	Est. Quantity	Unit Price (in words)	Unit Price (in Numbers)	Extended Amount (Qty x Unit Price) (in numbers)
12B Existing Infrastructure/Utility Conflicts (Allowance)	1-09	1 FA	Sixty Thousand Dollars and No Cents	\$60,000.00	\$60,000.00
13B 30-inch Diameter HDPE DR 11 Sewer Force Main	Div.22	5,800 LF		\$	\$
14B 2-inch Combination Air Vacuum Valve Assembly	Div. 40	2 EA		\$	\$
15B 3-inch Combination Air Vacuum Valve Assembly	Div. 40	1 EA		\$	\$
16B 4-inch Blowoff Valve Assembly	Div. 40	2 EA		\$	\$
17B IPS Sewer Lateral from ROW to Main	Div. 22	1 EA		\$	\$
18B 26-inch Diameter HDPE DR 11 45 Degree Bend	Div. 22	1 EA		\$	\$
19B 30-inch Diameter HDPE DR 11 45 Degree Bend	Div. 22	3 EA		\$	\$
20B 26-inch Diameter HDPE DR 11 Flange Adapter	Div. 22	4 EA		\$	\$
21B 30-inch Diameter HDPE DR 11 Flange Adapter	Div. 22	5 EA		\$	\$
22B Abandon Existing Force Main	Div. 33	6,000 LF		\$	\$
23B Pump Station 24 Improvements, Bypass, and Final Connections	1-09	1 LS		\$	\$

**Bid Schedule B – Intersection of NE Tagholm Road/Brownsville Highway to Station 277+90**

Item No.	Ref. Section	Est. Quantity	Unit Price (in words)	Unit Price (in Numbers)	Extended Amount (Qty x Unit Price) (in numbers)
24B Brownsville Hwy Connection	1-09	1 LS	_____	\$ _____	\$ _____
25B Connect to Existing 30-inch Diameter HDPE DR 11 Force Main	1-09	1 LS	_____	\$ _____	\$ _____
26B Asphalt Removal	Div. 32	9,000 SY	_____	\$ _____	\$ _____
27B Removal of Unsuitable Foundation Material (Allowance)	1-09	150 CY	_____	\$ _____	\$ _____
28B Import Trench Foundation Material (Allowance)	1-09	300 TN	_____	\$ _____	\$ _____
29B Trench Backfill	Div. 31	6,300 TN	_____	\$ _____	\$ _____
30B Crushed Surfacing Base Course (CSBC)	Div. 31	1,400 TN	_____	\$ _____	\$ _____
31B Crushed Surfacing Top Course (CSTC)	Div. 31	400 TN	_____	\$ _____	\$ _____
32B HMA Cl. ½-inch PG 58-22 for Trench Patch	Div. 32	1,200 TN	_____	\$ _____	\$ _____
33B HMA Cl. ½-inch PG 58-22 Extended	Div. 32	200 TN	_____	\$ _____	\$ _____
34B General Restoration	Div. 32	7,600 SF	_____	\$ _____	\$ _____
35B Replace Survey Monument (Allowance)	1-09	2 EA	_____	\$ _____	\$ _____

**Bid Schedule B – Intersection of NE Tagholm Road/Brownsville Highway to Station 277+90**

Item No.	Ref. Section	Est. Quantity	Unit Price (in words)	Unit Price (in Numbers)	Extended Amount (Qty x Unit Price) (in numbers)
<b>Subtotal of Schedule B – Station 219+40 to Station 278+00 Subtotal</b>				\$ _____	
<b>Sales Tax @ 9%</b>				\$ _____	
<b>Total for Schedule B – Station 219+40 to Station 278+00 Total</b>				\$ _____	

**TOTAL FOR SCHEDULES A AND B WITH SALES TAX**

\$ _____
----------

THIS PAGE INTENTIONALLY LEFT BLANK



**SALES TAX:**

All work identified in the bid schedule is subject to collection of Washington State sales tax on the Contract Price. Bidders should contact the Washington State Department of Revenue for further clarification of sales tax rules. If the project extends through a sales tax increase, the Contractor will be allowed a commensurate increase in the sales tax and adjustment in the contract amount. However, the Contracting Agency will not adjust payment if the Bidder bases a Bid on a misunderstood tax liability.

**AWARD OF SCHEDULES:**

The Proposal contains multiple schedules to assist the County in tracking the costs associated with separate components of the overall project. The intent of the County is to award a Contract for all schedules to the lowest responsive and responsible bidder provided the Bid has been submitted in accordance with the requirements of these specifications. However, the County reserves the right to award any of the schedules singularly or in combination thereof. Failure to complete all schedules in their entirety will result in the bid being non-responsive. The sum of all schedules will be used to determine the lowest responsible bidder.

**OPENING OF BIDS:**

Bids received prior to the time of opening will be kept unopened and secured until the time of the bid opening as specified in the Advertisement for Bids. No bid received thereafter will be considered. No responsibility will attach, and bidders waive any and all complaints against the County for premature opening of an improperly addressed or identified bid.

At the time and place fixed for the opening of bids, every bid received within appropriate time will be opened and publicly read aloud.

The Contracting Agency reserves the right to postpone the date and time for receiving and/or opening of bids at any time prior to the date and time established in the Advertisement for Bid. Postponement notices shall be mailed to bidders in the form of addenda.

The Contracting Agency may reject all bids if they exceed budgeted cost or the Contracting Agency may negotiate bid pricing with the apparent low responsive bidder including changes in the contract plans and specifications, to bring the bid within budgeted cost.

**CONTRACT AND BOND:**

If notified of the acceptance of this bid within sixty (60) days of the time set for opening of bids, the undersigned agrees to execute a contract for the above work, for a compensation computed from the above-stated sums, on the Contract Form bound with the specifications and to furnish a bond as required by the specifications on the form bound therein.

**BID GUARANTEE:**

It is agreed that if the undersigned fails to execute said Contract and furnish said Bond within ten (10) days after written notice of award of Contract, then the Bid Guarantee shall be retained by the County as liquidated damages. If this bid is not accepted within sixty (60) days after the time set for the opening of bids, or if the undersigned delivers said Contract and Bond in a timely manner, then the check or cash shall be returned, or the Bid Bond shall become void.

SIGNATURE

Signed By: \_\_\_\_\_ Date: \_\_\_\_\_

Please Print Name: \_\_\_\_\_ Title: \_\_\_\_\_

Name of Firm: \_\_\_\_\_

Address: \_\_\_\_\_

Telephone: (\_\_\_\_\_) \_\_\_\_\_ Fax: (\_\_\_\_\_) \_\_\_\_\_

**END OF BID PROPOSAL**

**BID GUARANTY BOND  
2022-104 IFB**

KNOW ALL MEN BY THESE PRESENTS, that we, the undersigned, \_\_\_\_\_, hereinafter called the Principal, and \_\_\_\_\_, hereinafter called the Surety, are jointly and severally held and firmly bound unto the Kitsap County Department of Public Works, hereinafter called the Obligee, each in the penal sum of five percent (5%) of the total amount of the Bid of the Principal for the work, this sum not to exceed \_\_\_\_\_dollars (\$\_\_\_\_\_) of lawful money of the United States for the payment thereof unto the Obligee, the Principal, and Surety jointly and severally bind themselves forever firmly by these presents.

WHEREAS, the Principal is herewith submitting its offer for the fulfillment of Obligee's contract for construction of: **Bangor Keyport Force Main Replacement**.

NOW, THEREFORE, the condition of this obligation is such that if the Principal is awarded the contract, and if the Principal, within the time specified in the bid for such contract, enters into, executes, and delivers to the Obligee an agreement in the form provided herein complete with evidences of insurance, and if the Principal within the time specified in the bid gives the Performance and Payment Bond on the form provided herein to the Obligee, then this obligation shall be void; otherwise, the Principal and Surety will pay unto the Obligee the difference in the money between the total amount of the Bid of the Principal and the amount for which the Obligee legally contracts with another party to fulfill the Contract if the latter amount be in excess of the former, but in no event shall the Surety's liability exceed the penal sum hereof.

AND IT IS HEREBY DECLARED AND AGREED that the Surety shall be liable under this obligation as Principal, and that nothing of any kind or nature whatsoever that will not discharge the Principal shall operate as a discharge or a release of liability of the Surety.

IT IS HEREBY FURTHER DECLARED AND AGREED that this obligation shall be binding upon and inure to the benefit of the Principal, the Surety, and the Obligee and their respective heirs, executors, administrators, successors, and assigns.

SIGNED AND SEALED this \_\_\_\_\_ day of \_\_\_\_\_, 20\_\_\_\_.

*Contractor's Corporate Seal*

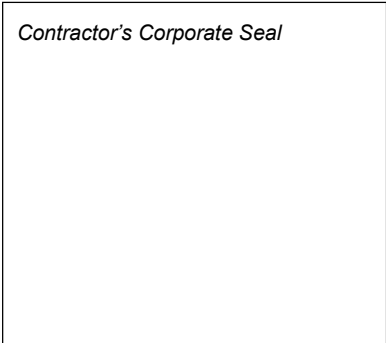

\_\_\_\_\_  
Principal

\_\_\_\_\_  
Signature for Principal

\_\_\_\_\_  
Title of Signatory

*Surety's Corporate Seal*

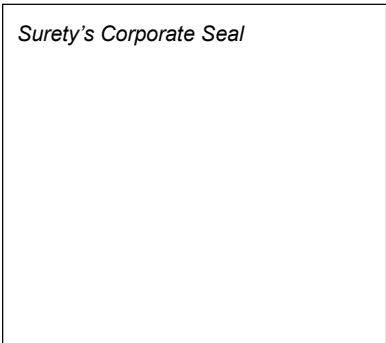

\_\_\_\_\_  
Surety

\_\_\_\_\_  
Signature for Surety

\_\_\_\_\_  
Title of Signatory

**END OF BID GUARANTEE BOND**

**SUBCONTRACTORS LIST**

Each Bidder is advised of the requirements of Washington Law, RCW 39.30.060. Pursuant to Title 39 of the Revised Code of Washington, each bidder is required to submit as part of the bid or within one hour after the published bid submittal time, the names of the subcontractors with whom the bidder, if awarded the contract, will subcontract for performance of the work of heating, ventilation and air conditioning; plumbing as described in RCW 18.106 and electrical as described in RCW 19.28 or to name itself for the work. Additionally, each bidder is required to submit as part of the bid or within 48-hours after the published bid submittal time, the names of the subcontractors with whom the bidder, if awarded the contract, will subcontract for performance of the work of structural steel and rebar. The Bidder shall not list more than one subcontractor for each category of work identified, unless subcontractors vary with bid alternates, in which case the bidder must indicate which subcontractor will be used for which alternate. Failure of the bidder to submit the names of such subcontractors or to name itself to perform such work or the naming of two or more subcontractors to perform the same work shall render the bidder's bid non-responsive and, therefore, void.

**List subcontractors appropriately**

**HEATING, VENTILATION AND AIR CONDITIONING**

Subcontractor Name: \_\_\_\_\_

**PLUMBING**

Subcontractor Name: \_\_\_\_\_

**ELECTRICAL**

Subcontractor Name: \_\_\_\_\_

**STRUCTURAL STEEL INSTALLATION**

Subcontractor Name: \_\_\_\_\_

**REBAR INSTALLATION**

Subcontractor Name: \_\_\_\_\_

**HOT MIX ASPHALT (HMA) PAVING (Note: This is required by this contract and not RCW 39.30.060)**

Subcontractor Name: \_\_\_\_\_

***SUBCONTRACTORS LIST***

---

CURED-IN-PLACE PIPE (CIPP) (Note: This is required by this contract and not RCW 39.30.060)

Subcontractor Name: \_\_\_\_\_

WET WELL COATING (Note: This is required by this contract and not RCW 39.30.060)

Subcontractor Name: \_\_\_\_\_

OTHER SUBCONTRACTORS (whose work is equal to or greater than 10% of the bid)  
(Note: This is required by this contract and not RCW 39.30.060)

\_\_\_\_\_  
\_\_\_\_\_  
\_\_\_\_\_  
\_\_\_\_\_

**[THIS FORM SHALL BE COMPLETED IN FULL AND SUBMITTED WITH THE BID PROPOSAL]**

**END OF SUBCONTRACTORS LIST**

## BIDDER INFORMATION

Contracting Firm Name:
Number of Years Contractor has been in the construction business under its present firm name:
Present gross dollar amount of work under contract:
Present gross dollar amount remaining to be completed of work under contract:
General type of work performed by firm:

List the five major pieces of equipment to be used on this project:	Owned	Leased	Rented
1.			
2.			
3.			
4.			
5.			

List the name of the Project Manager and Superintendent responsible for this project	# of Years with Firm
Name of Project Manager:	
Name of Superintendent:	

Bank Reference:
Have you changed bonding companies within the last three years?
If so, why? (Optional)

Have you ever been sued by the client or have you ever sued the client on any public works contract for a special purpose district, municipality, county, or state government? \_\_\_\_\_

For what reason? \_\_\_\_\_

Disposition of case, if settled: \_\_\_\_\_

Do you have any outstanding payments due to the Department of Revenue? \_\_\_\_\_

If yes, describe the plan to address those payments \_\_\_\_\_

Bidder agrees that the County shall retain the right to obtain any and all credit reports?

(\_\_\_\_\_) \_\_\_\_\_  
Yes      Signature

In the last 5 years, has the Bidder had a three-year average Experience Modification Rate (EMR) no greater than 1.1 (Include EMR documentation)?

(\_\_\_\_\_) \_\_\_\_\_  
Yes/No      Signature

Does the Bidder have sufficient bonding capacity?

(\_\_\_\_\_) \_\_\_\_\_  
Yes/No      Signature

The Bidder shall include with their Bid a notarized statement from an admitted and Washington State approved surety insurer, which states that Bidder's current bonding capacity is sufficient for this project.

In the last five (5) years, has the Bidder had their Contractor's license revoked?

(\_\_\_\_\_) \_\_\_\_\_  
Yes/No      Signature

In the last five (5) years, has the Bidder been "defaulted" or "terminated" by an owner (other than for convenience of the owner)?

(\_\_\_\_\_) \_\_\_\_\_  
Yes/No      Signature



**BIDDER INFORMATION**

---

In the last five (5) years, has the Bidder been convicted of a crime involving the awarding of a contract of a government (local, state, or federal) construction project or the bidding or performance of a government construction contract?

(\_\_\_\_\_) \_\_\_\_\_

Yes/No      Signature

In the last five (5) years, has the Bidder been found guilty in a criminal action, for making any false claim or material misrepresentations to any public agency or entity?

(\_\_\_\_\_) \_\_\_\_\_

Yes/No      Signature

In the last five (5) years, has the Bidder been convicted of a crime involving any federal, state or local law related to construction, including acts of dishonesty?

(\_\_\_\_\_) \_\_\_\_\_

Yes/No      Signature

**[THIS FORM SHALL BE COMPLETED IN FULL AND SUBMITTED WITH THE BID PROPOSAL]**

**BIDDER RESPONSIBILITY CHECKLIST**

The following checklist will be used to document that the Bidder meets the bidder responsibility criteria. Please print a copy of documentation from the appropriate website to be included with the submittal.

<b>General Information</b>	
Project Name: Bangor-Keyport Force Main Replacement	Formal Bid Contract Number: 2022-104
Bidder's Business Name:	Bid Submittal Deadline:
<b>Contractor Registration</b>	
License Number:	Status: Active: Yes <input type="checkbox"/> No <input type="checkbox"/>
Effective Date (must be effective on or before Bid Submittal Deadline):	Expiration Date:
<b>Contractor Infraction List</b>	
Is Bidder on Infraction List? Yes <input type="checkbox"/> No <input type="checkbox"/>	
<b>Current UBI Number</b>	
UBI Number:	Account Status: Open <input type="checkbox"/> Closed <input type="checkbox"/>
<b>Industrial Insurance Coverage</b>	
Account Number:	Account Current: Yes <input type="checkbox"/> No <input type="checkbox"/>
<b>Employment Security Department Number</b>	
Employment Security Department Number:	
Provide a copy of latest correspondence containing bidder's account number with Employment Security Department. Do not provide document containing personal information such as social security numbers.	
<b>State Excise Tax Registration Number</b>	
Tax Registration Number:	Account Status: Open <input type="checkbox"/> Closed <input type="checkbox"/>
<b>Not Disqualified from Bidding</b>	
Has the Bidder been listed on the "Contractors Not Allowed to Bid" list of the Department of Labor and Industries in the last two (2) years? Yes <input type="checkbox"/> No <input type="checkbox"/>	
<b>Bankruptcy</b>	
Has the Bidder declared Bankruptcy in the last five (5) years? Yes <input type="checkbox"/> No <input type="checkbox"/>	
<b>Information Supplied by:</b>	
Print Name of Bidder Representative:	Date:

**[THIS FORM SHALL BE COMPLETED IN FULL AND SUBMITTED WITH THE BID PROPOSAL]**

**SUBCONTRACTOR RESPONSIBILITY CHECKLIST**

The following checklist will be used to document that the Bidder meets the mandatory bidder responsibility criteria. Please print a copy of documentation from the appropriate website to be included with the submittal.

<b>General Information</b>	
Project Name: Bangor-Keyport Force Main Replacement	Formal Bid Contact Number: 2022-104
Subcontractor's Business Name:	Bid Submittal Deadline:
<b>Contractor Registration</b>	
License Number:	Status: Active: Yes <input type="checkbox"/> No <input type="checkbox"/>
Effective Date (must be effective on or before Subcontract Bid Submittal Deadline):	Expiration Date:
<b>Contractor Infraction List</b>	
Is Subcontractor on Infraction List? Yes <input type="checkbox"/> No <input type="checkbox"/>	
<b>Current UBI Number</b>	
UBI Number:	Account Status: Open <input type="checkbox"/> Closed <input type="checkbox"/>
<b>Industrial Insurance Coverage</b>	
Account Number:	Account Current: Yes <input type="checkbox"/> No <input type="checkbox"/>
<b>Employment Security Department Number</b>	
Employment Security Department Number:	
Please provide a copy of latest correspondence containing subcontractor's account number with Employment Security Department. Do not provide document containing personal information such as social security numbers.	
<b>State Excise Tax Registration Number</b>	
Tax Registration Number:	Account Status: Open <input type="checkbox"/> Closed <input type="checkbox"/>
<b>Not Disqualified from Bidding</b>	
Is the Subcontractor listed on the "Contractors Not Allowed to Bid" list of the Department of Labor and Industries? Yes <input type="checkbox"/> No <input type="checkbox"/>	
<b>Contractor Licenses</b>	
<u>Electrical</u> : If required by Chapter 19.28 RCW, does the Subcontractor have an Electrical Contractor's License? Yes <input type="checkbox"/> No <input type="checkbox"/>	<u>Elevator</u> : If required by Chapter 70.87 RCW, does the Subcontractor have an Elevator Contractor's License? Yes <input type="checkbox"/> No <input type="checkbox"/>
<b>Checked by:</b>	
Name of Employee:	Date:

**[THIS FORM SHALL BE COMPLETED IN FULL FOR EACH SUBCONTRACTOR AND SUBMITTED WITH THE BID PROPOSAL]**

**PROJECT REFERENCES**

Using the following form (use additional forms as needed), the Bidder shall describe projects that meet the similar size and scope criteria of Section 1-02.1.

Project Name: \_\_\_\_\_

Project Manager: \_\_\_\_\_ Project Superintendent: \_\_\_\_\_

Public Agency Name: \_\_\_\_\_

Contact Person: \_\_\_\_\_ Phone No: \_\_\_\_\_

Awarded Contract Amount: \_\_\_\_\_ Final Contract Amount: \_\_\_\_\_

Project Start Date: \_\_\_\_\_ Project Completion Date: \_\_\_\_\_

Project Location: \_\_\_\_\_

Project Scope: \_\_\_\_\_

\_\_\_\_\_

\_\_\_\_\_

\_\_\_\_\_

\_\_\_\_\_

\_\_\_\_\_

\_\_\_\_\_

\_\_\_\_\_

\_\_\_\_\_

\_\_\_\_\_

\_\_\_\_\_

Claims, if any, filed by the Contractor and the basis for the claims: \_\_\_\_\_

\_\_\_\_\_

\_\_\_\_\_

**[This form(s) shall be completed in full and submitted within 48 hours of the bid submittal deadline by the two lowest bidders and other bidders as requested by the Contracting Agency.]**

**END OF BIDDER INFORMATION**

**NON-COLLUSION AFFIDAVIT**

The undersigned, being duly sworn, deposes and says that the person, firm, association, co-partnership or corporation herein named, has not, either directly or indirectly, entered into any agreement, participated in any collusion, or otherwise taken any action in restraint of free competitive bidding in the preparation and submission of this proposal to Kitsap County for its consideration in the award of the contract.

\_\_\_\_\_ Sole Proprietorship \_\_\_\_\_  
Legal Name of Bidder  
\_\_\_\_\_ Partnership \_\_\_\_\_  
\_\_\_\_\_ Corporation \_\_\_\_\_  
By (Signature) \_\_\_\_\_  
\_\_\_\_\_ Other \_\_\_\_\_

\_\_\_\_\_ Street Address

\_\_\_\_\_ City \_\_\_\_\_ State \_\_\_\_\_ Zip \_\_\_\_\_

\_\_\_\_\_ Telephone

\_\_\_\_\_ State of Washington Contractor's Number

STATE OF WASHINGTON)  
( \_\_\_\_\_ ) SS.  
COUNTY OF KITSAP)

On this day personally appeared before me \_\_\_\_\_ to me known to be the individual described in and who executed the within and foregoing instrument, and acknowledged that \_\_\_\_\_ signed the same as \_\_\_\_\_ free and voluntary act and deed, for the uses and purposes therein mentioned.

GIVEN under my hand and official seal this \_\_\_\_\_ day of \_\_\_\_\_, 20\_\_\_\_

\_\_\_\_\_ Notary Public in and for the State of Washington, residing at

My Commission Expires: \_\_\_\_\_

**[THIS FORM SHALL BE COMPLETED IN FULL AND SUBMITTED WITH THE BID PROPOSAL]**

**END OF NON-COLLUSION AFFIDAVIT**

THIS PAGE INTENTIONALLY LEFT BLANK

**CERTIFICATION OF COMPLIANCE WITH WAGE PAYMENT STATUTES**

The bidder hereby certifies that, within the three-year period immediately preceding the bid solicitation date of February 7, 2022, the bidder is not a “willful” violator, as defined in RCW 49.48.082, of any provision of chapters 49.46, 49.48, or 49.52 RCW, as determined by a final and binding citation and notice of assessment issued by the Department of Labor and Industries or through a civil judgment entered by a court of limited or general jurisdiction.

I certify under penalty of perjury under the laws of the State of Washington that the foregoing is true and correct.

\_\_\_\_\_  
Bidder’s Business Name

\_\_\_\_\_  
Signature of Authorized Official\*

\_\_\_\_\_  
Printed Name

\_\_\_\_\_  
Title

\_\_\_\_\_  
Date City State

*Check One:*

Sole Proprietorship  Partnership  Joint Venture  Corporation

State of Incorporation, or if not a corporation, State where business entity was formed:

\_\_\_\_\_

If a co-partnership, give firm name under which business is transacted:

\_\_\_\_\_

*\* If a corporation, proposal must be executed in the corporate name by the president or vice-president (or any other corporate officer accompanied by evidence of authority to sign). If a co- partnership, proposal must be executed by a partner.*

**[THIS FORM SHALL BE COMPLETED IN FULL AND SUBMITTED WITH THE BID PROPOSAL]**

**END OF CERTIFICATION OF COMPLIANCE WITH WAGE PAYMENT STATUTES**

THIS PAGE INTENTIONALLY LEFT BLANK



## BIDDER'S CHECKLIST

NOTE: The purpose of this checklist is to serve as a reminder of major items to be addressed in submitting a bid and by the Successful Bidder after notification of award, and is not intended to be all-inclusive. It does not alleviate the Bidder from the responsibility of becoming familiar with all aspects of the Project Manual and proper completion and submission of the Bid.

1. Contract Documents thoroughly read and understood. \_\_\_\_\_
2. Attend pre-bid conference. \_\_\_\_\_
3. All blank spaces in proposal filled in, preferably in black ink. \_\_\_\_\_
4. Receipt of all addenda acknowledged. \_\_\_\_\_
5. Review of geotechnical information acknowledged. \_\_\_\_\_
6. Bid Form and other documents are signed by authorized officer. \_\_\_\_\_
7. Prices computed and presented correctly. \_\_\_\_\_
8. Subcontractors are named as indicated in the Contract Documents. \_\_\_\_\_
9. The following documents, to be submitted with the bid, completed, signed, and dated as applicable. \_\_\_\_\_
  - a. Bid Proposal \_\_\_\_\_
  - b. Bid Guaranty Bond \_\_\_\_\_
  - c. Subcontractors List \_\_\_\_\_
  - d. Bidder Information \_\_\_\_\_
    - i. Bidder Responsibility Checklist \_\_\_\_\_
    - ii. Subcontractor Responsibility Checklist \_\_\_\_\_
  - e. Non-Collusion Affidavit Certificate \_\_\_\_\_
  - f. Certification of Compliance with Wage Payment Statutes \_\_\_\_\_
10. Bid documents submitted in sealed envelope and properly labeled. \_\_\_\_\_
11. The following documents shall be executed and complied with after the contract is awarded: \_\_\_\_\_
  - a. Capital Projects Contract Agreement \_\_\_\_\_
  - b. Performance and Payment Bond \_\_\_\_\_
  - c. Insurance Certificates \_\_\_\_\_

**END OF BIDDER'S CHECKLIST**

THIS PAGE INTENTIONALLY LEFT BLANK

## CONTRACT REQUIREMENTS

THIS PAGE INTENTIONALLY LEFT BLANK

**CAPITAL PROJECTS CONTRACT AGREEMENT**  
**KC CONTRACT # \_\_\_\_\_**

This Contract is made and entered into this \_\_\_\_\_ day of \_\_\_\_\_, 2022 between KITSAP COUNTY, with its principal offices at 614 Division Street, Port Orchard, Washington 98366, hereinafter called the Contracting Agency, and \_\_\_\_\_, a general Contractor licensed in the State of Washington, with its principal offices located at \_\_\_\_\_, hereinafter the Contractor.

**WITNESSETH:**

WHEREAS, the Contracting Agency desires to construct the **Bangor-Keyport Force Main Replacement** and

WHEREAS, the Contractor has been selected by competitive bid as the responsible bidder with the lowest responsive bid as is required by Chapter 39.04 RCW.

NOW THEREFORE, the Contracting Agency and Contractor mutually agree as follows:

**1. CONTRACT DOCUMENTS**

The Agreement between the parties is expressed in the Contract Documents, which include the Invitation to Bid; the accepted Bid Proposal; the Bid Guaranty Bond; the Subcontractor's List; the Bidder Information; the Non-Collusion Affidavit; the Performance and Payment Bond; the Special Provisions; the Project Drawings; the Standard Specifications and Standard Plans; the Storm Water Pollution Prevention Plan; the Project Permits; and this Agreement.

**2. DESCRIPTION OF THE WORK**

This contract provides for the construction of approximately 5 miles of sanitary sewer force main construction, individual pump station connections, Pump Station 17 and 24 improvements and miscellaneous site restoration in accordance with the Contract Documents entitled "Bangor-Keyport Force Main Replacement." Contractor agrees to furnish all material, labor, carriage, tools, equipment, apparatus, facilities and anything else necessary to complete the work in a professional and workmanlike manner.

The Contractor shall complete its Work in a timely manner and in general accordance with the agreed schedule submitted by the Contractor and approved by the Contracting Agency.

**3. CONTRACT REPRESENTATIVES**

Each party to this Contract shall have a representative. Each party may change its representative upon providing written notice to the other party. These representatives will be:

CONTRACTING AGENCY:

Name of Representative:	Floyd Bayless
Title:	Construction Manager
Mailing Address:	614 Division Street MS #27
City, State, and Zip Code:	Port Orchard, WA 98366
Telephone Number:	360-337-5777
Email Address:	<a href="mailto:fbayless@co.kitsap.wa.us">fbayless@co.kitsap.wa.us</a>

**CAPITAL PROJECTS CONTRACT AGREEMENT**

---

**CONTRACTOR:**

Name of Representative: \_\_\_\_\_

Title: \_\_\_\_\_

Mailing Address: \_\_\_\_\_

City, State, and Zip Code: \_\_\_\_\_

Telephone Number: \_\_\_\_\_

Fax Number: \_\_\_\_\_

Email Address: \_\_\_\_\_

All instructions, modifications, and changes to the Contract shall be conveyed to the Contractor through the Contracting Agency's Representative. Any work executed upon the direction of any person or entity other than the Contracting Agency's Representative may be considered defective and will be performed without reimbursement for said work to the Contractor. The Contracting Agency's Representative shall have the authority to reject any and all nonconforming or defective work under the Project Documents.

**4. CONTRACT AMOUNT**

The Contracting Agency hereby agrees to pay the Contractor according to the Contractor's Bid in the amount of \$ \_\_\_\_\_ (including accepted alternates and Washington State Sales Tax (WSST)), at the time and manner and upon the conditions provided for in this Contract.

**5. CONTRACT TIME**

Time is of the essence in the performance of this Contract. The Contractor agrees to work promptly and fully complete the work within the limits as described in the Contract Documents. Failure to complete the work within the allowed time limit as described in Section 1-08.5 of the Special Provisions will subject the Contractor to the payment of liquidated damages as described in Section 1-08.9 of the Standard Specifications and the Special Provisions.

**6. PREVAILING WAGES**

Contractor shall be responsible for complying with the prevailing wage requirements associated with RCW Chapter 39.12 and WAC 296-127 as further described in Section 1-07.9 of the Standard Specifications and the Special Provisions.

**7. PERFORMANCE AND PAYMENT BOND**

Contractor agrees to provide a Performance and payment Bond as described in Section 1-03.4 of the Standard Specifications as amended by the Special Provisions.

**8. HOLD HARMLESS AND INDEMNIFICATION**

The Contractor shall hold harmless, indemnify and defend the Contracting Agency, Engineer, its officers, officials, employees and agents, from and against any and all claims, actions, suits, liability, loss, expenses, damages, and judgments of any nature whatsoever, including, but not limited to, reasonable costs and attorneys' fees in defense thereof, for injury, sickness, disability or death to persons or damage to property or business, caused by or arising out of the performance of the services rendered under this contract by the Contractor, its employees, agents, or subcontractors or anyone for whose acts any of them may be liable. Provided however, that the Contractor's obligation hereunder shall not extend to injury, sickness, death or damage caused by or arising out of the sole negligence of the Contracting Agency, its officers, officials, employees or agents. Provided further, that in the event of the concurrent negligence of the parties, the Contractor's obligations hereunder shall apply only to the percentage of fault attributable to the Contractor, its employees, agents, or subcontractors.

In any and all claims against the Contracting Agency, Engineer, its officers, officials, employees and agents by any employee of the Contractor, subcontractor, anyone directly or indirectly employed by any of them, or anyone for whose acts any of them may be liable, the indemnification obligation under this Section shall not be limited in any way by any limitation on the amount or type of damages, compensation, or benefits payable by or for the Contractor or subcontractor under Worker's Compensation acts, disability benefit acts, or other employee benefit acts, it being clearly agreed and understood by the parties hereto that the Contractor expressly waives any immunity the Contractor might have had under such laws. By executing the Contract, the Contractor acknowledges that the foregoing waiver has been mutually negotiated by the parties and that the provisions of this Section shall be incorporated, as relevant, into any contract the Contractor makes with any subcontractor or agent performing Work hereunder.

The Contractor's obligations hereunder shall include, but are not limited to, investigating, adjusting and defending all claims alleging loss from action, error or omission, or breach of any common law, statutory or other delegated duty by the Contractor, the Contractor's employees, agents or subcontractors.

**9. INSURANCE**

Contractor agrees to comply with the insurance requirements described in Section 1-07.18 of the Special provisions.

**10. TERMINATION**

This contract may be terminated by the officials or agents of the County authorized to contract for or supervise the execution of such work in accordance with Section 1-08.10 of the Standard Specifications as amended by the Special Provisions.

**11. NON-WAIVER OF RIGHTS**

The parties agree that the excuse or forgiveness of performance or waiver of any provisions of this Contract does not constitute a waiver of such provisions for future performance, or prejudice the right of the waiving party to enforce any of the provisions of this Contract at a later time.

**12. INDEPENDENT CONTRACTOR**

The Contractor shall perform this Contract as an Independent Contractor and not as an agent, employee or servant of the Contracting Agency. The parties agree that the Contractor is not entitled to any benefits or rights enjoyed by employees of the County. Contractor shall comply with all laws regarding workers' compensation.

The Contractor specifically has the right to direct and control Contractor's own activities in providing the agreed services in accordance with the specifications set out in this Contract. Furthermore, the Contractor shall have and maintain complete responsibility and control over all of its subcontractors, employees, agents, and representatives. No subcontractor, employee, agent, or representative of the Contractor shall be or deem to be or act or purport to act as an employee, agent, or representative of the Contracting Agency, unless otherwise directed by the terms of this Contract.

The Contractor agrees to immediately remove any of its employees or agents from assignment to perform services under this Contract upon receipt of a written request to do so from the Contracting Agency's Representative or designee.

**13. NONDISCRIMINATION**

The Contractor, its assignees, delegates, or subcontractors in the performance of this Contract shall not discriminate against any person on the basis of race, color, creed, religion, national origin, age, sex, marital status, sexual orientation, veteran status, disability, or other circumstance prohibited by federal, state, or local law, and shall comply with Title VI of the Civil Rights Act of 1964, P.L. 88 354 and Americans with Disabilities Act of 1990.

**14. CHOICE OF LAW, JURISDICTION AND VENUE**

Any action at law, suit in equity, or other judicial proceeding for the enforcement of this contract or any provisions thereof shall be instituted as provided for in RCW 36.01.050. It is mutually understood and agreed that this contract shall be governed by the laws of the State of Washington, both as to interpretation and performance.

**15. SUCCESSORS AND ASSIGNS**

The Contracting Agency, to the extent permitted by law, and the Contractor each bind themselves, their partners, successors, executors, administrators, and assigns to the other Party to this Contract and to the partners, successors, administrators, and assigns of such other party in respect to all covenants of this Contract.

**16. ASSIGNMENT, DELEGATION, AND SUBCONTRACTING**

- a. The CONTRACTOR shall perform the terms of the contract using only its bona fide employees or agents, and the obligations and duties of the CONTRACTOR under this Contract shall not be assigned, delegated, or subcontracted to any other person or firm without the prior express written consent of the COUNTY.
- b. The CONTRACTOR warrants that it has not paid nor has it agreed to pay any company, person, partnership, or firm, other than a bona fide employee working exclusively for CONTRACTOR, any fee, commission, percentage, brokerage fee, gift, or other consideration contingent upon or resulting from the award or making of this Contract.

**17. SEVERABILITY**

If a court of competent jurisdiction holds any part, term or provision of this Contract to be illegal, or invalid in whole or in part, the validity of the remaining provisions shall not be affected, and the parties' rights and obligations shall be construed and enforced as if the Contract did not contain the particular provision held to be invalid.

If it should appear that any provision of this Contract is in conflict with any statutory provision of the United States or the State of Washington, said provision which may conflict therewith shall be deemed inoperative and null and void insofar as it may be in conflict therewith, and shall be deemed modified to conform to such statutory provision.

**18. ENTIRE AGREEMENT**

The parties agree that this Contract is the complete expression of its terms and conditions. Any oral or written representations or understandings not incorporated in this Contract are specifically excluded.

**19. NOTICES**

Any notices shall be effective if personally served upon the other party or if mailed by registered or certified mail, return receipt requested, to the addresses set out in Section 3. Notice may also be given by facsimile with the original to follow by regular mail. Notice shall be deemed to be given three days following the date of mailing or immediately if personally served. For service by facsimile, service shall be effective upon receipt during working hours. If a facsimile is sent after working hours, it shall be effective at the beginning of the next working day.

**20. THIRD PARTY BENEFICIARY**

All parties agree that the State of Washington shall be, and is hereby, named as an express third-party beneficiary of this contract, with full rights as such.

**21. MODIFICATION**

All amendments or modifications shall be in writing, signed by both parties, and attached to this Contract.

**22. COMPLIANCE WITH LAWS**

The CONTRACTOR shall comply with all applicable federal, state and local laws, rules and regulations in performing this Contract.



**CAPITAL PROJECTS CONTRACT AGREEMENT**

---

**23. COMPLIANCE WITH PUBLIC RECORDS ACT**

Contractor acknowledges that the County is subject to the Public Records Act, chapter 42.56 RCW ("PRA"). All records owned, used, or retained by the County are public records subject to disclosure unless exempt under the Act, whether or not such records are in the possession or control of the County or Contractor. Contractor shall cooperate with the County so County may comply with all of its obligations under the Act. Contractor shall promptly provide County with all records relating to this Agreement requested by County for purposes of complying with the PRA. In addition to its other indemnification and defense obligations under this Agreement, Contractor shall indemnify and defend the County from and against any and all losses, penalties, fines, claims, demands, expenses (including, but not limited to, attorney's fees and litigation expenses), suits, judgments, or damage arising from or relating to any failure of Contractor to comply with this subsection. This subsection shall survive expiration or termination of the Agreement.

This Contract shall take effect this \_\_\_\_\_ day of \_\_\_\_\_, 2022.

CONTRACTOR:

BOARD OF COUNTY COMMISSIONERS  
Kitsap County, Washington

Firm \_\_\_\_\_

\_\_\_\_\_  
Robert Gelder, Chair

By \_\_\_\_\_

Signature: \_\_\_\_\_  
(Authorized Representative)

\_\_\_\_\_  
Edward E. Wolfe, Commissioner

Title \_\_\_\_\_

Address: \_\_\_\_\_

\_\_\_\_\_  
Charlotte Garrido, Commissioner

\_\_\_\_\_

Attest:

Contractor Registration No. \_\_\_\_\_

\_\_\_\_\_  
Dana Daniels, Clerk of the Board

Federal Tax ID No. \_\_\_\_\_

**Approved as to form by the Prosecuting Attorney's Office.**

**END OF CAPITAL PROJECTS CONTRACT AGREEMENT**

THIS PAGE INTENTIONALLY LEFT BLANK

**PUBLIC WORKS PAYMENT BOND  
TO KITSAP COUNTY, WA**

**Bond No. \_\_\_\_\_**

Kitsap County, Washington, (County) has awarded to \_\_\_\_\_ (Principal), a contract for the construction of the project designated as **Bangor-Keyport Force Main Replacement**, Kitsap County Contact #KC-\_\_\_\_-\_\_\_\_, in Kitsap County, Washington (Contract), and said Principal is required under the terms of that Contract to furnish a payment bond in accord with Title 39.08 Revised Code of Washington (RCW) and (where applicable) 60.28 RCW.

The Principal, and \_\_\_\_\_ (Surety), a corporation organized under the laws of the State of \_\_\_\_\_ and licensed to do business in the State of Washington as surety and named in the current list of "Surety Companies Acceptable in Federal Bonds" as published in the Federal Register by the Audit Staff Bureau of Accounts, U.S. Treasury Dept., are jointly and severally held and firmly bound to the County, in the sum of \_\_\_\_\_ US Dollars (\$ \_\_\_\_\_) Total Contract Amount, subject to the provisions herein.

This statutory payment bond shall become null and void, if and when the Principal, its heirs, executors, administrators, successors, or assigns shall pay all persons in accordance with RCW Titles 39.08 and 39.12 including all workers, laborers, mechanics, subcontractors, and material suppliers, and all persons who shall supply such contractor or subcontractor with provisions and supplies for the carrying on of such work; and if such payment obligations have not been fulfilled, this bond shall remain in full force and effect.

The Surety for value received agrees that no change, extension of time, alteration or addition to the terms of the Contract, the specifications accompanying the Contract, or to the work to be performed under the Contract shall in any way affect its obligation on this bond, except as provided herein, and waives notice of any change, extension of time, alteration or addition to the terms of the Contract or the work performed. The Surety agrees that modifications and changes to the terms and conditions of the Contract that increase the total amount to be paid the Principal shall automatically increase the obligation of the Surety on this bond and notice to Surety is not required for such increased obligation.

This bond may be executed in two (2) original counterparts, and shall be signed by the parties' duly authorized officers. This bond will only be accepted if it is accompanied by a fully executed and original power of attorney for the officer executing on behalf of the surety.

PRINCIPAL

SURETY

Principal Signature \_\_\_\_\_ Date \_\_\_\_\_ Surety Signature \_\_\_\_\_ Date \_\_\_\_\_

Printed Name \_\_\_\_\_ Printed Name \_\_\_\_\_

Title \_\_\_\_\_ Title \_\_\_\_\_

Name, address, and telephone of local office/agent of Surety Company are:

Approved as to form:

Signature \_\_\_\_\_ Title \_\_\_\_\_ Date \_\_\_\_\_

THIS PAGE INTENTIONALLY LEFT BLANK

**PERFORMANCE BOND  
TO KITSAP COUNTY, WA**

**Bond No. \_\_\_\_\_**

The Kitsap County, Washington, (County) has awarded to \_\_\_\_\_(Principal), a contract for the construction of the project designated as **Bangor-Keyport Force Main Replacement**, Kitsap County Contact #KC-\_\_\_\_-\_\_\_\_, in Kitsap County, Washington (Contract), and said Principal is required to furnish a bond for performance of all obligations under the Contract.

The Principal, and \_\_\_\_\_(Surety), a corporation organized under the laws of the State of \_\_\_\_\_and licensed to do business in the State of Washington as surety and named in the current list of "Surety Companies Acceptable in Federal Bonds" as published in the Federal Register by the Audit Staff Bureau of Accounts, U.S. Treasury Dept., are jointly and severally held and firmly bound to the County, in the sum of \_\_\_\_\_US Dollars (\$\_\_\_\_\_ ) Total Contract Amount, subject to the provisions herein.

This statutory performance bond shall become null and void, if and when the Principal, its heirs, executors, administrators, successors, or assigns shall well and faithfully perform all of the Principal's obligations under the Contract and fulfill all the terms and conditions of all duly authorized modifications, additions, and changes to said Contract that may hereafter be made, at the time and in the manner therein specified; and if such performance obligations have not been fulfilled, this bond shall remain in full force and effect.

The Surety for value received agrees that no change, extension of time, alteration or addition to the terms of the Contract, the specifications accompanying the Contract, or to the work to be performed under the Contract shall in any way affect its obligation on this bond, and waives notice of any change, extension of time, alteration or addition to the terms of the Contract or the work performed. The Surety agrees that modifications and changes to the terms and conditions of the Contract that increase the total amount to be paid the Principal shall automatically increase the obligation of the Surety on this bond and notice to Surety is not required for such increased obligation.

This bond may be executed in two (2) original counterparts, and shall be signed by the parties' duly authorized officers. This bond will only be accepted if it is accompanied by a fully executed and original power of attorney for the officer executing on behalf of the surety.

PRINCIPAL

SURETY

Principal Signature \_\_\_\_\_ Date \_\_\_\_\_ Surety Signature \_\_\_\_\_ Date \_\_\_\_\_

Printed Name \_\_\_\_\_ Printed Name \_\_\_\_\_

Title \_\_\_\_\_ Title \_\_\_\_\_

Name, address, and telephone of local office/agent of Surety Company are:

Approved as to form:

Signature \_\_\_\_\_ Title \_\_\_\_\_ Date \_\_\_\_\_

**THIS PAGE INTENTIONALLY LEFT BLANK**

## SPECIAL PROVISIONS

THIS PAGE INTENTIONALLY LEFT BLANK



## INTRODUCTION TO THE SPECIAL PROVISIONS

The work on this project shall be accomplished in accordance with the *Standard Specifications for Road, Bridge and Municipal Construction*, 2021 edition, as issued by the Washington State Department of Transportation (WSDOT) and the American Public Works Association (APWA), Washington State Chapter (hereafter “Standard Specifications”). The Standard Specifications, as modified or supplemented by these Special Provisions, all of which are made a part of the Contract Documents, shall govern all of the Work.

These Special Provisions are made up of both General Special Provisions (GSPs) from various sources, which may have project-specific fill-ins; and project-specific Special Provisions. Each Provision either supplements, modifies, or replaces the comparable Standard Specification, or is a new Provision. The deletion, amendment, alteration, or addition to any subsection or portion of the Standard Specifications is meant to pertain only to that particular portion of the section, and in no way should it be interpreted that the balance of the section does not apply.

The project-specific Special Provisions are not labeled as such. The GSPs are labeled under the headers of each GSP, with the effective date of the GSP and its source. For example:

*(March 8, 2013 APWA GSP)*  
*(April 1, 2013 WSDOT GSP)*

Project specific Special Provisions are labeled under the heading of each Special Provision as follows:

(Local Agency SP)

The specifications also include Construction Specification Institute (CSI) formatted specifications Divisions 1 to 41 (6-digit format). The CSI specifications are supplemental to the WSDOT Special Provisions and WSDOT standards.

Also incorporated into the Contract Documents by reference are:

1. *Manual on Uniform Traffic Control Devices for Streets and Highways*, currently adopted edition, with Washington State modifications, if any
2. *Standard Plans for Road, Bridge and Municipal Construction, WSDOT/APWA, current edition*

Contractor shall obtain copies of these publications, at Contractor’s own expense.

**END OF INTRODUCTION**

THIS PAGE INTENTIONALLY LEFT BLANK

**1-01 Definitions and Terms****1-01.3 Definitions**

*Section 1-01.3 is supplemented as follows:  
(Local Agency SP)*

All references in the Standard Specifications, Amendments, or WSDOT General Special Provisions, to the terms “State”, “Department of Transportation”, “Washington State Transportation Commission”, “Commission”, “Secretary of Transportation”, “Secretary”, “Headquarters”, and “State Treasurer” shall be revised to read “Contracting Agency”.

All references to “State Materials Laboratory” shall be revised to read “Contracting Agency designated location”.

All references to “final contract voucher certification” shall be interpreted to mean the final payment form established by the Contracting Agency.

The venue of all causes of action arising from the advertisement, award, execution, and performance of the contract shall be in the Superior Court of the County where the Contracting Agency’s headquarters are located.

**Acceptance** – Formal action of the Owner in determining that the Contractor's work has been completed in accordance with the contract and in notifying the Contractor in writing of the acceptability of the work.

**Act of God** – A cataclysmic phenomenon of nature, such as an earthquake, flood or cyclone. Rain, wind, high water, or other natural phenomenon which might reasonably have been anticipated from historical records of the general locality of the work shall not be construed as acts of God.

**Additive** – A supplemental unit of work or group of bid items, identified separately in the Bid Proposal, which may, at the discretion of the Contracting Agency, be awarded in addition to the base bid.

**Alternate** – One of two or more units of work or groups of bid items, identified separately in the Bid Proposal, from which the Contracting Agency may make a choice between different methods or material of construction for performing the same work.

**Application for Payment** – The form accepted by the Engineer which is to be used by the Contractor in requesting progress and final payments and which is to include such supporting documentation as is required by the Contract Documents.

**Bid Proposal Form** – Bid Proposal Form shall mean the same as the definition provided for the term “Proposal Form.”

**Business Day** – A business day is any day from Monday through Friday except holidays as listed in Section 1-08.5.

**Construction Manager** – The person designated, in writing, by the Owner to act as its representative and to perform administrative functions relating to this contract. Initial contact by the Contractor with the Owner shall be through the Construction Manager.

**Contract Bond** – The definition in the Standard Specifications for “Contract Bond” applies to whatever bond form(s) are required by the Contract Documents, which may be a combination of a Payment Bond and a Performance Bond.

**Contract Documents** – See definition for “Contract”.

**Contract Drawings** – Contract Drawings or Drawings shall mean the same as the definition provided for the term “Contract Plans” or “Plans.”

**Contracting Agency** – The Contracting Agency shall mean Kitsap County, a municipal corporation, acting and existing under the laws of the State of Washington.

**Contract Price** – The amount payable to the Contractor under the terms and conditions of the contract provisions based on the lump sum prices, unit prices, or combination thereof, on the Bidding Schedule, with adjustments made in accordance with the Contract.

**Contract Time** – The period of time established by the terms and conditions of the contract within which the work must be physically completed.

**Dates** – Delete the heading Completion Dates and the three paragraphs that follow it, and replace them with the following:

**Bid Opening Date** – The date on which the Contracting Agency publicly opens and reads the bids.

**Award Date** – The date of the formal decision of the Contracting Agency to accept the lowest, responsible and responsive bidder for the work.

**Contract Execution Date** – The date the Contracting Agency officially binds the agency to the Contract.

**Limited Notice to Proceed with Construction Date** – The date stated in the Limited Notice to Proceed on which the Preconstruction Phase contract time begins.

**Notice to Proceed with Construction Date** – The date stated in the Notice to Proceed with Construction on which the Construction Phase contract time begins.

**Substantial Completion Date** – The day the Engineer determines the Contracting Agency has full and unrestricted use and benefit of the facilities, both from the operational and safety standpoint, any remaining traffic disruptions will be rare and brief, and only minor incidental work, replacement of temporary substitute facilities, plant establishment periods, or correction or repair remains for the physical completion of the total contract.

**Physical Completion Date** – The day all of the work is physically completed on the project. All documentation required by the Contract and required by law does not necessarily need to be furnished by the Contractor by this date.

**Completion Date** – The day all the work specified in the contract is completed and all the obligations of the Contractor under the contract are fulfilled by the Contractor. All documentation required by the contract and required by law must be furnished by the Contractor before establishment of this date.

**Final Acceptance Date** – The date on which the Contracting Agency accepts the work as complete.

**EADOC** – The web-based electronic media site that is hosted by EADOC LLC. Information may be obtained at [www.EADOCsoftware.com](http://www.EADOCsoftware.com). EADOC is a project management system for facilitating document workflows, communication, and collaboration, which assists in the management of construction projects. It serves as a single source for project information for communication and collaboration among all project participants by automating various tasks in an organization of modules. EADOC provides secure, permissions-based access requiring the identification of all users and their approved access rights.

**Electronic Documents** – The electronic form or image of Project Communications that can be stored on and retrieved from an electronic storage device through a collaboration system over the Internet. Includes all written and graphic products produced with computer software or converted to electronic form or electronic image by computer software.

**Engineer** – Engineer shall mean either the Contracting Agency’s design engineer or the Contracting Agency’s construction administration representative.

**Field Directive** – A written order issued by Engineer which requires minor changes in the Work, but which does not involve a change in the Contract Price or the Contract Times.

**Invitation to Bid** – The definition is the same as that provided for the term “Call for Bids.”

**Limited Notice to Proceed** – Written notice from the Contracting Agency informing the successful Bidder to start the Work associated with the Preconstruction Work Phase. See Section 1-04.3 for additional information.

**Notice** – As defined in the Contract. Notice for documents transmitted through EADOC is the time and date when the document is sent to the other party as recorded in EADOC.

**Notice of Award** – The written notice from the Contracting Agency to the successful Bidder signifying the Contracting Agency’s acceptance of the Bid Proposal.

**Notice to Proceed with Construction** – The written notice from the Contracting Agency or Engineer to the successful Bidder authorizing and directing the Contractor to proceed with the Construction Work Phase. The Notice to Proceed with Construction establishes the date on which the contract time begins. See Sections 1-04.3 and 1-08.4 for additional information.

**Owner** – The definition is the same as that provided for the term “Contracting Agency”.

**Performance and Payment Bond** – The definition is the same as that provided for the term “Contract Bond.” The Contractor will be required to submit a Performance and Payment Bond on the Contracting Agency provided form within ten (10) calendar days of receipt of Notice of Award.

**Project Communications** – All written documentation and written communications required by the Contract Documents including, but not limited to: correspondence, reports, notices, submittals, transmittals, RFI’s, request for change orders, payment applications, change orders, claims, change proposals, field orders, meeting agendas and minutes, substitutions, test reports, monitoring reports, punchlists, and all other formal Contract communications. Project communications shall also include documents required by the Contract that include written documents, demands, instruments, or directives, unless otherwise indicated in this Section.

**Project Data** – Samples, certifications, material specifications, installation procedures, catalog data or other materials, equipment, or other information intended to describe items to be furnished by the Contractor for the project and which are identified as required submittals in the Standard Specifications and Special Provisions.

**Project Team** – The associated members of the Owner, Owner Consultants, Construction Manager, Design Engineer, Contractor, Subcontractors, and Vendors.

**Quality Assurance** – A program establishing policies, procedures, standards, training, guidelines, testing, and systems necessary to provide quality in the work to meet the project requirements and accepted industry standards.

**Quality Control** – Those activities that provide confidence that materials and workmanship will meet the requirements of the contract to fulfill the project objectives. The Contractor is responsible for the quality control of the project.

**Shop Drawings** – Drawings prepared by the Contractor or his/her suppliers or subcontractors to describe detailed dimensions and materials of items to be furnished for the work. Shop drawings are not contract Drawings.

**Total Bid Price** – The sum of all bid prices offered by the bidder as set forth in the Bidding Schedule on the Bid Proposal form.

**Traffic** - Both vehicular and non-vehicular traffic, such as pedestrians, bicyclists, wheelchairs, and equestrian traffic.

**Work Directive** – A written directive to the Contractor, recommended by the Engineer, issued on or after the effective date of the Notice to Proceed and signed by the Contracting Agency’s Representative, ordering an addition, deletion or revision in the Work, or responding to differing or unforeseen physical conditions under which the Work is to be performed, or to emergencies. A Work Directive may or may not change Contract Price or Contract Time, but is evidence that the parties expect that the change directed or documented by the Work Directive will be incorporated in a subsequently issued Change Order following negotiations of the parties as to its effect, if any, on the Contract Price or Contract Time.

**END OF SECTION 1-01**

THIS PAGE INTENTIONALLY LEFT BLANK

**1-02 Bid Procedures and Conditions****1-02.1 Prequalification of Bidders**

*Section 1-02.1 is deleted and replaced with the following:  
(Local Agency SP)*

**1-02.1 Bidder Responsibility**

It is the intent of the Contracting Agency to award a contract to the lowest responsive, and responsible bidder. Before award, the bidder must meet the following bidder responsibility criteria to be considered a responsible bidder. The bidder will be required by the Contracting Agency to submit documentation demonstrating compliance with the criteria. The bidder must:

1. Have a current certificate of registration as a contractor in compliance with Chapter 18.27 RCW at the time of bid submittal;
2. Have a current Washington Unified Business identifier (UBI) number;
3. If applicable, have:
  - a. Industrial insurance coverage for the bidder's employees working in Washington as required in Title 51 RCW;
  - b. A Washington Employment Security Department number per Title 50 RCW;
  - c. A Washington Department of Revenue state excise tax registration number as required in Title 82 RCW;
4. Not be disqualified from bidding on any public works contract under RCW 39.06.010 or 39.12.065(3).
5. Have current bonding capacity adequate for this project.
6. Not have filed for bankruptcy in the last five (5) years.
7. Not have had their Contractor's license revoked in the last five (5) years.

**1-02.1(1) Subcontractor Responsibility**

The Contractor shall include the language of this section in each of its first tier subcontracts, and shall require each of its subcontracts to include the same language of this section in each of their subcontracts, adjusting only as necessary the terms used for the contracting parties. Upon request of the Contracting Agency, the Contractor shall promptly provide documentation to the Contracting Agency demonstrating that the subcontractor meets the subcontractor responsibility criteria below. The requirements of this section apply to all subcontractors regardless of tier. The subcontractor shall:

1. Have a current certificate of registration as a contractor in compliance with Chapter 18.27 RCW at the time of subcontract bid submittal;
2. Have a current Washington Unified Business identifier (UBI) number;
3. If applicable, have:
  - a. Industrial insurance coverage for the subcontractor's employees working in Washington as required in Title 51 RCW;
  - b. A Washington Employment Security Department number per Title 50 RCW;
  - c. A Washington Department of Revenue state excise tax registration number as required in Title 82 RCW; and/or
  - d. An electrical contractor license, if required by Chapter 19.28 RCW.
4. Not be disqualified from bidding on any public works contract under RCW 39.06.010 or 39.12.065(3).

**1-02.1(2) Supplemental Bidder Responsibility Criteria**

In addition to the bidder responsibility criteria above, the bidder must meet the following relevant supplemental bidder responsibility criteria applicable to the project:

1. Bidder shall not be "inactive" or "not in good standing with the Washington State Secretary of State's Office, the Department of Revenue, or the Department of Labor and Industries.
2. Bidder shall have been in business as an underground pipeline construction contractor under its present name for a minimum of two (2) years;
3. Bidder shall not have been disqualified from entering a construction contract by another governmental agency in the last two (2) years;
4. Bidder shall not have declared bankruptcy or been in receivership in the last five (5) years;
5. Bidder, Bidder's designated project manager, and Bidder's designated superintendent/foreman for this project shall each have successfully completed at least three (3) projects of a similar size and scope as required by the Contract Documents for this project within the last ten (10) years. In evaluating whether the project were "successfully completed," the Contracting Agency may check references for the previous projects and may evaluate the bidder's performance including but not limited to, the following areas:
  - a. Quality control;
  - b. Safety record;
  - c. Timeliness of performance;
  - d. Use of skilled personnel, including subcontractors;
  - e. Management of subcontractors;
  - f. Availability of and use of appropriate equipment;
  - g. Compliance with contract documents;
  - h. Management of submittals process, change orders and closeout.
6. Bidder shall not owe delinquent taxes to the Washington State Department of Revenue without a payment plan approved by the Department of Revenue.

For purposes of meeting this criterion, the Contracting Agency has determined that "similar size and scope" means municipal public works projects that include HDPE sewer force main pipe installations with a minimum inside diameter of 18-inches and a minimum length of 15,000 LF. All of the following shall be included: cleaning/prepping and coating a wet well, cured-in-place pipe rehabilitation and odor control fan installation. Separate projects may be used to demonstrate compliance with these installation requirements. Each project shall also have a construction cost in excess of \$15,000,000.

### **1-02.1(3) Documentation**

As evidence the bidder meets the responsibility criteria above, the Bidder shall complete and submit the following documentation as part of the Bidder's Bid Proposal.

1. Bidder Responsibility Checklist.
2. Subcontractor Responsibility Checklist, provide for each subcontractor identified in Bidder's Subcontractors List.

In addition, the two lowest bidders must submit the following documentation for each referenced project to the Contracting Agency within 48 hours of the bid submittal deadline. The Contracting Agency reserves the right to request such documentation from other bidders. In the event a bidder refuses to provide the requested information or fails to provide the requested information within the time periods specified in the Bid Documents, then the Contracting Agency may find the bidder non-responsible.

1. Documented information from the Washington State Secretary of State's Office, the Department of Revenue, or the Department of Labor and Industries providing the date of incorporation or formation, the state of incorporation or formation, that the bidder is active and in good standing in the State of Washington, State of Washington tax reporting



- number, and the name and address of the registered agent, general partner, or managing member.
2. Bidder shall not be listed on the Washington State Department of Revenue's "Delinquent Taxpayer List" website: <http://dor.wa.gov/content/fileandpaytaxes/latefiling/dtlwest.aspx>.
  3. List of projects of similar size and scope. This list shall include the following for each project:
    - a. Project Name.
    - b. Project Manager's Name and Project Superintendent's Name.
    - c. Project owner's name and contact information for the project owner's representative.
    - d. Awarded contract amount.
    - e. Final contract amount.
    - f. Project start and completion date.
    - g. Location of the project.
    - h. A description of the scope of the project and how the project is similar to this project. The description should include, but not be limited to the pump size and capacity, the site work that was required, the ground conditions encountered, and other information relevant to the successful completion of the referenced project.
    - i. Claims (either resolved or unresolved) filed by the Contractor and basis for the claims.

The basis for evaluation of Bidder compliance with these supplemental criteria shall be any documents or facts obtained by the Contracting Agency (whether from the Bidder or third parties) which any reasonable owner would rely on for determining such compliance, including but not limited to:

1. Financial, historical, or operational data from the Bidder.
2. Information obtained directly by the Contracting Agency from owners for whom the Bidder has worked, or other public agencies or private enterprises.
3. Any additional information obtained by the Contracting Agency which is believed to be relevant to the matter.

#### **1-02.1(4) Appeals**

If the Contracting Agency determines the bidder does not meet the bidder responsibility above and is therefore not a responsible bidder, the Contracting Agency shall notify the bidder in writing with the reasons for its determination. If the bidder disagrees with this determination, it may appeal the determination within 24 hours of receipt of the Contracting Agency's determination by presenting additional information to the Contracting Agency. The Contracting Agency will consider the additional information before issuing its final determination. If the final determination affirms that that bidder is not responsible, the Contracting Agency will not execute a contract with any other bidder until two (2) business days after the bidder determined to be not responsible has received the final determination. For purposes of this section, the date of the Contracting Agency's transmission of the Contracting Agency's determination(s) by facsimile or electronic mail to the bidder at the facsimile number or email address provided by the bidder in its bid shall constitute the date of receipt by the bidder of the written notices provided for herein.

#### **1-02.1(5) Other Conditions**

Specialty contractor experience and qualification requirements are specified in other sections of the Special Provisions. While the Contractor will be required to conform to those additional qualifications, they are not criteria that will be evaluated as a condition for determining if the bidder is responsible.

If two or more prospective bidders desire to bid jointly as a Joint Venture on a single contract, each must be deemed qualified, as provided above, and they must also include with the bid proposal packet an agreement to Joint Venture. The Joint Venture is then treated as a new firm and qualified as such. The Joint Venture and any of its members are subject to the conditions as stated elsewhere within these specifications. Any agreement to Joint Venture shall be signed by each of the bidders and must specify each individual who is authorized to execute proposals, contracts, bond and other documents on behalf of the Joint Venture. If any of the bidders is a corporation, the agreement must be accompanied by a resolution of the corporation authorizing such Joint Venture agreement and designating the officer(s) authorized to sign such Joint Venture agreement or contract on behalf of such corporation.

**1-02.2 Plans and Specifications**

*Section 1-02.2 is deleted and replaced with the following:  
(Local Agency SP)*

Information as to where Bid Documents can be obtained or reviewed will be found in the Invitation to Bid for the work.

After award of the contract, conformed plans and specifications will be issued to the Contractor at no cost as detailed below:

To Prime Contractor	No. of Sets	Basis of Distribution
Reduced plans (11" x 17")	5	Furnished automatically with the limited NTP
Standard plans (22" x 34")	2	Furnished automatically with the limited NTP
Contract Provisions	5	Furnished automatically with the limited NTP

Additional copies of the Contract Plans and Contract Provisions may be purchased by the Contractor by payment of the cost of reproduction and delivery charges.

**1-02.4(2) Subsurface Information**

*The first paragraph of Section 1-02.4(2) is deleted and replaced with the following:  
(Local Agency SP)*

The Contracting Agency has made limited subsurface investigations and the boring log data and soil sample test data accumulated by the Contracting Agency is available in an appendix in the Bid Documents. This data is informational only and shall not be considered as part of the Contract. The Contracting Agency makes no representation or warranty expressed or implied that:

1. The Bidder's interpretations from the boring logs are correct.
2. Moisture conditions and indicated water tables will not vary from those found at the time the borings were made.
3. The ground at the location of the borings has not been physically disturbed or altered after the boring was made.

The Contractor may not rely upon or make any claim against the Contracting Agency or Engineer with respect to:

1. The completeness of such data and reports for Contractor's purposes, including, but not limited to any aspects of the means, methods, techniques, sequences, and procedures of construction to be employed by Contractor, and safety precautions and programs incident thereto; or
2. Other data, interpretations, opinions, and information contained in such reports; or

3. Any Contractor interpretation of, or conclusion, drawn from such technical data or any such other data, interpretations, opinions, or information.

The Contractor is advised that additional geotechnical investigations and engineering could be required and should be considered and taken into account as part of the requirements of the work. Such investigations and engineering could be required to augment or support the available technical data, particularly to assess or verify the in-situ conditions in areas which were not investigated in order to meet the Contractor's needs and requirements for construction, especially for shoring, dewatering, or other special construction that is dependent on, and affected by, site specific in-situ conditions. Contractor shall evaluate his needs for this additional information and all costs for gathering said information shall be incidental to other bid items.

### **1-02.5 Proposal Forms**

*(July 31, 2017 APWA GSP)*

Delete this section and replace it with the following:

The Proposal Form will identify the project and its location and describe the work. It will also list estimated quantities, units of measurement, the items of work, and the materials to be furnished at the unit bid prices. The bidder shall complete spaces on the proposal form that call for, but are not limited to, unit prices; extensions; summations; the total bid amount; signatures; date; and, where applicable, retail sales taxes and acknowledgment of addenda; the bidder's name, address, telephone number, and signature; the bidder's UDBE/DBE/M/WBE commitment, if applicable; a State of Washington Contractor's Registration Number; and a Business License Number, if applicable. Bids shall be completed by typing or shall be printed in ink by hand, preferably in black ink. The required certifications are included as part of the Proposal Form.

The Contracting Agency reserves the right to arrange the proposal forms with alternates and additives, if such be to the advantage of the Contracting Agency. The bidder shall bid on all alternates and additives set forth in the Proposal Form unless otherwise specified.

### **1-02.6 Preparation of Proposal**

*(December 10, 2020 APWA GSP, Option B)*

Supplement the second paragraph with the following:

4. If a minimum bid amount has been established for any item, the unit or lump sum price must equal or exceed the minimum amount stated.
5. Any correction to a bid made by interlineation, alteration, or erasure, shall be initialed by the signer of the bid.

Delete the last two paragraphs, and replace them with the following:

The Bidder shall submit with their Bid a completed Contractor Certification Wage Law Compliance form, provided by the Contracting Agency. Failure to return this certification as part of the Bid Proposal package will make this Bid Nonresponsive and ineligible for Award. A Contractor Certification of Wage Law Compliance form is included in the Proposal Forms.

The Bidder shall make no stipulation on the Bid Form, nor qualify the bid in any manner.

A bid by a corporation shall be executed in the corporate name, by the president or a vice president (or other corporate officer accompanied by evidence of authority to sign).

A bid by a partnership shall be executed in the partnership name, and signed by a partner. A copy of the partnership agreement shall be submitted with the Bid Form if any UDBE requirements are to be satisfied through such an agreement.

A bid by a joint venture shall be executed in the joint venture name and signed by a member of the joint venture. A copy of the joint venture agreement shall be submitted with the Bid Form if any UDBE requirements are to be satisfied through such an agreement.

**1-02.7 Bid Deposit**

*Section 1-02.7 is supplemented with the following:  
(Local Agency SP)*

Bid bonds shall contain the following:

1. Contracting Agency-assigned number for the project;
2. Name of the project;
3. The Contracting Agency named as obligee;
4. The amount of the bid bond stated either as a dollar figure or as a percentage which represents five percent of the maximum bid amount that could be awarded;
5. Signature of the bidder's officer empowered to sign official statements. The signature of the person authorized to submit the bid should agree with the signature on the bond, and the title of the person must accompany the said signature;
6. The signature of the surety's officer empowered to sign the bond and the power of attorney.

Bid bonds shall be issued by a surety company licensed to do business in the State of Washington. Bidder shall use the bond form included in the Contract Provisions.

Bid bonds and checks will be returned to all except the three lowest bidders within ten (10) days after the bid award. Bid bonds or checks of each of the three lowest bidders will be returned within three (3) days after execution of the Contract, and after the Contract has been executed and approved by Kitsap County.

**1-02.9 Delivery of Proposal**

*The first and second paragraphs of Section 1-02.9 are deleted and replaced with the following  
(Local Agency SP)*

Each Bid Proposal shall be submitted in a sealed envelope, with the Project Name and Formal Bid Contract Number as stated in the Invitation to Bid clearly marked on the outside of the envelope, or as otherwise stated in the Bid Documents, to ensure proper handling and delivery.

The Contracting Agency will not open or consider any Bid Proposal that is received after the time specified in the Invitation to Bid for receipt of Bid Proposals, or received in a location other than that specified in the Call for Bids.

**1-02.10 Withdrawing, Revising, or Supplementing Proposal**

*The second paragraph of Section 1-02.10 is deleted and replaced with the following:  
(Local Agency SP)*

The bidder has no right to withdraw or modify the bid for any reason whatsoever after the time set for the opening thereof, unless the award of the contract is delayed for a period exceeding sixty (60) days from the time set for opening of the bids.

Prior to the time set for opening of bids, a bidder may withdraw or revise his bid proposal, provided that an individual authorized to sign proposals files the request for withdrawal or revision with the County Purchasing Office in writing. The original proposal, as modified in writing by an attached revision filed before the time set for opening of bids will be considered as the bid proposal by the bidder. No oral, fax, telephone, or telegraphic Bid Proposals or modifications will be considered or accepted.

**1-02.13 Irregular Proposals**

*Item 1 in Section 1-02.13 is revised to read as follows:  
(Local Agency SP)*

1. A proposal will be considered irregular and will be rejected if:
  - a. The bidder is not prequalified when so required;
  - b. The authorized proposal form furnished by the Contracting Agency is not used or is altered;
  - c. The completed proposal form contains any unauthorized additions, deletions, alternate bids, or conditions;
  - d. The bidder adds provisions reserving the right to reject or accept the award, or enter into the contract;
  - e. A price per unit cannot be determined from the bid proposal;
  - f. The proposal form is not properly executed;
  - g. The bidder fails to submit or properly complete a subcontractor list, if applicable, as required in Section 1-02.6.
  - h. The bidder fails to submit or properly complete a Disadvantaged Business Enterprise Certification, if applicable, as required in Section 1-02.6;
  - i. The Bidder fails to submit written confirmation from each DBE firm listed on the Bidder's completed DBE Utilization Certification that they are in agreement with the bidders DBE participation commitment, if applicable, as required in Section 1-02.6, or if the written confirmation that is submitted fails to meet the requirements of the Special Provisions;
  - j. The Bidder fails to submit DBE Good Faith Effort documentation, if applicable, as required in Section 1-02.6, or if the documentation that is submitted fails to demonstrate that a Good Faith Effort to meet the Condition of Award was made;
  - k. The bid proposal does not constitute a definite and unqualified offer to meet the material terms of the bid invitation, or
  - l. More than one proposal is submitted for the same project from a Bidder under the same or different names.
  - m. The bidder fails to submit or properly complete a Bidder Responsibility Checklist as required in Section 1-02.1(3).
  - n. The bidder fails to submit or properly complete a Subcontractor Responsibility Checklist for each subcontractor as required in Section 1-02.1(3).

*Item 2 in Section 1-02.13 is supplemented with the following:  
(Local Agency SP)*

- f. If the County, for good cause, deems the bid bond inadequate or improper.

**1-02.14 Disqualification of Bidders**

*Section 1-02.14 is supplemented with the following:  
(Local Agency SP)*

A Bidder will be deemed not responsible if:

1. The Bidder does not meet the mandatory bidder responsibility criteria in RCW 39.04.350(1), as amended; or
2. The Bidder fails to meet the Project-specific supplemental bidder responsibility criteria listed in Section 1-02.1.

**1-02.15 Pre Award Information**

*Section 1-02.15 is revised to read as follows:  
(August 14, 2013 APWA GSP)*

Before awarding any contract, the Contracting Agency may require one or more of these items or actions of the apparent lowest responsible bidder:

1. A complete statement of the origin, composition, and manufacture of any or all materials to be used,
2. Samples of these materials for quality and fitness tests,
3. A progress schedule (in a form the Contracting Agency requires) showing the order of and time required for the various phases of the work,
4. A breakdown of costs assigned to any bid item,
5. Attendance at a conference with the Engineer or representatives of the Engineer,
6. Obtain, and furnish a copy of, a business license to do business in the city or county where the work is located.
7. Any other information or action taken that is deemed necessary to ensure that the bidder is the lowest responsible bidder.

**1-02.16 Addenda**

*Section 1-02.16 is added as the following:  
(Local Agency SP)*

Where appropriate, responses to questions, inquiries or requests for additional information or for substitution of proposed material will be issued in the form of Addenda, and copies of each addendum will be issued to all prospective bidders of record. Additionally, addenda are on file at the Kitsap County Purchasing Office. During the bidding period, prospective bidders will be advised by Addendum of additions to, deletions from or changes in the requirements of the contract documents.

Kitsap County will not be responsible for the authenticity or correctness of oral interpretations of contract documents or for information obtained in any other manner than through the media of Addenda. Bidders shall acknowledge receipt of Addendum in their bid proposals and each Addendum shall be considered a part of the Contract Documents. Failure to acknowledge receipt of any Addenda issued will invalidate a

Should a bidder have a Request for Clarification or find discrepancies, ambiguities or omissions in the drawings or specifications, or should a bidder be in doubt as to their meaning, bidder shall at once notify Floyd Bayless, Construction Manager, at (360) 337-5631 or email [fbayless@co.kitsap.wa.us](mailto:fbayless@co.kitsap.wa.us). If appropriate, the Contracting Agency will send a written instruction to all bidders in the form of an Addendum. Neither the Contracting Agency nor the Engineer may be held responsible for any oral instruction. Questions received by the Contracting Agency less than seventy-two (72) hours before bids close may not be answered. All addenda issued prior to the time of bid closing are incorporated into the contract.

Interpretations, corrections and changes of the Bidding documents will be made by addendum only through the Kitsap County Purchasing Office. Interpretations, corrections and changes in the Bidding Documents made in any other manner will not be binding, and Bidders shall not rely upon them.

Any variances to the contract documents shall not be accepted unless agreed to by the County in writing. Substitutions will not be considered until after award of contract.

**END OF SECTION 1-02**

**1-03 Award and Execution of Contract****1-03.1 Consideration of Bids**

*The first paragraph of Section 1-03.1 is revised to read as follows:  
(January 23, 2006 APWA GSP)*

After opening and reading proposals, the Contracting Agency will check them for correctness of extensions of the prices per unit and the total price. If a discrepancy exists between the price per unit and the extended amount of any bid item, the price per unit will control. If a minimum bid amount has been established for any item and the bidder's unit or lump sum price is less than the minimum specified amount, the Contracting Agency will unilaterally revise the unit or lump sum price, to the minimum specified amount and recalculate the extension. The total of extensions, corrected where necessary, including sales taxes where applicable and such additives and/or alternates as selected by the Contracting Agency, will be used by the Contracting Agency for award purposes and to fix the Awarded Contract Price amount and the amount of the contract bond.

*Section 1-03.1 is supplemented with the following:  
(Local Agency SP)*

The Contracting Agency will consider all material submitted by the bidder to determine whether the bidder's offering is in compliance with the Contract Documents. The Contracting Agency will consider all material submitted by the bidder, and evidence it may obtain otherwise, to determine whether the bidder, its key personnel, and proposed subcontractors have the qualifications and experience to successfully complete contracts of this type. Such evaluation will include, but not be limited to, the following factors: 1) whether the bidder has adequate financial resources to complete the work; 2) whether the bidder has the necessary experience and organization to perform the work; 3) whether the bidder has a satisfactory record of performance, integrity, experience, and skills to perform and complete the work; 4) whether the bidder has a history of completing, failing to complete, defaulting on or otherwise not completing construction contracts; and 5) whether the bidder's proposed major subcontractors appear capable of and have histories of successfully completing construction contracts.

**1-03.3 Execution of Contract**

*Section 1-03.3 is revised to read as follows:  
(Local Agency SP)*

Copies of the Contract Provisions, including the unsigned Form of Contract, will be available for signature by the successful bidder following award. The number of copies to be executed by the Contractor will be determined by the Contracting Agency.

Within fourteen (14) calendar days after receipt of the Contracting Agency-prepared contract, the successful bidder shall return the signed Contracting Agency-prepared contract, an insurance certification as required by Section 1-07.18, and a satisfactory bond as required by law and Section 1-03.4. Before execution of the contract by the Contracting Agency, the successful bidder shall provide any pre-award information the Contracting Agency may require under Section 1-02.15.

Until the Contracting Agency executes a contract, no proposal shall bind the Contracting Agency nor shall any work begin within the project limits or within Contracting Agency-furnished sites. The Contractor shall bear all risks for any work begun outside such areas and for any materials ordered before the contract is executed by the Contracting Agency.

If the bidder experiences circumstances beyond their control that prevents return of the contract documents within the calendar days after the award date stated above, the Contracting Agency may grant up to a maximum of fourteen (14) additional calendar days for return of the documents, provided the Contracting Agency deems the circumstances warrant it.

**1-03.4 Contract Bond**

*(July 23, 2015 APWA GSP)*

Delete the first paragraph and replace it with the following:

The successful bidder shall provide executed payment and performance bond(s) for the full contract amount. The bond may be a combined payment and performance bond; or be separate payment and performance bonds. In the case of separate payment and performance bonds, each shall be for the full contract amount. The bond(s) shall:

1. Be on Contracting Agency-furnished form(s);
2. Be signed by an approved surety (or sureties) that:
  - a. Is registered with the Washington State Insurance Commissioner, and
  - b. Appears on the current Authorized Insurance List in the State of Washington published by the Office of the Insurance Commissioner,
3. Guarantee that the Contractor will perform and comply with all obligations, duties, and conditions under the Contract, including but not limited to the duty and obligation to indemnify, defend, and protect the Contracting Agency against all losses and claims related directly or indirectly from any failure:
  - a. Of the Contractor (or any of the employees, subcontractors, or lower tier subcontractors of the Contractor) to faithfully perform and comply with all contract obligations, conditions, and duties, or
  - b. Of the Contractor (or the subcontractors or lower tier subcontractors of the Contractor) to pay all laborers, mechanics, subcontractors, lower tier subcontractors, material person, or any other person who provides supplies or provisions for carrying out the work;
4. Be conditioned upon the payment of taxes, increases, and penalties incurred on the project under titles 50, 51, and 82 RCW; and
5. Be accompanied by a power of attorney for the Surety's officer empowered to sign the bond; and
6. Be signed by an officer of the Contractor empowered to sign official statements (sole proprietor or partner). If the Contractor is a corporation, the bond(s) must be signed by the president or vice president, unless accompanied by written proof of the authority of the individual signing the bond(s) to bind the corporation (i.e., corporate resolution, power of attorney, or a letter to such effect signed by the president or vice president).

**END OF SECTION 1-03**



**1-04 Scope of the Work****1-04.1(2) Bid Items Not Included in the Proposal**

*Section 1-04.1(2) is deleted and replaced with the following:  
(Local Agency SP)*

When the Contract specifies Work that has no Bid Item in the Bid Proposal, that work shall be considered incidental to other items in the Bid Proposal whether specified as incidental or not in the measurement and payment descriptions for the individual Bid Items.

**1-04.2 Coordination of Contract Documents, Plans, Special Provisions, Specifications, and Addenda**

*The second paragraph of Section 1-04.2 is revised to read as follows:  
(Local Agency SP)*

Any inconsistency in the parts of the contract shall be resolved by following this order of precedence (e.g., 1 presiding over 2, 2 over 3, 3 over 4, and so forth):

1. Change Orders,
2. Work Directives,
3. Addenda,
4. Proposal Form,
5. CSI Special Provisions,
6. WSDOT Special Provisions,
7. Contract Plans,
8. Amendments to the Standard Specifications,
9. Standard Specifications,
10. Contracting Agency's Standard Plans or Details (if any), and
11. WSDOT Standard Plans for Road, Bridge, and Municipal Construction.

**1-04.3 Preconstruction Work Phase**

*Section 1-04.3 is added as follows:  
(Local Agency SP)*

This Section specifies planning and work included within the Preconstruction Work Phase that takes place during the period after the Limited Notice to Proceed and prior to the start of the work authorized by the Notice to Proceed with Construction. The planning effort includes identifying and organizing the Contractor's work team, attending a preconstruction public meeting whose purpose is to introduce the Contractor to the public impacted by the project, planning the construction activities with Kitsap County, the Construction Manager, and Design Engineer, establishing the initial survey control, preparing and delivering priority submittals for equipment, and other activities related to planning activities identified herein.

To accomplish the preconstruction activities, the Contractor shall provide staff to meet on the project site as needed and shall establish and maintain an office in the Puget Sound region to accomplish the work. Satisfactory completion of the Preconstruction Work Phase activities will be a prerequisite to the Notice to Proceed with Construction for the Construction Work Phase.

Submittal information shall be provided in sufficient detail to verify compliance with the specifications during the Preconstruction Work Phase and shall be provided prior to Notice to Proceed with Construction for the Construction Work Phase. The Contractor shall make arrangements with subcontractors and suppliers for the preparation and submittal of required documentation.

**1-04.3(1) Activities**

The following is a list of the activities to be included in the Preconstruction Work Phase. Each of the activities and required work products are defined either within this specification or in specification sections in the Special Provisions.

1. Contractor's Management and Work Plan
2. Project Safety and Accident Prevention Program
3. COVID-19 Health and Safety Plan (CHSP)
4. Onsite Investigations
5. Preconstruction Photographs
6. Submittals
  1. Submittal Plan and Schedule
  2. Priority or Long Lead Time Material Submittals
  3. Priority Technical Submittals
    - a. Dewatering Plan(s)
    - b. Erosion Control Plan(s)
    - c. Sheeting, Shoring, and Bracing Plan(s)
    - d. Spill Prevention, Control, and Countermeasures Plan
    - e. Temporary Sewage Bypass Plan(s)
7. Apply for and Obtain Contractor Furnished Permits
8. Spill Prevention, Control, and Countermeasures Plan
9. Schedules
  - a. Contractor's Scheduler Qualifications
  - b. Schedule of Values for Lump Sum Bid Items
  - c. Contractor's Construction Schedule
10. Traffic Control Plan(s)
11. Attend EADOC Training

**1-04.3(2) Contractor's Management and Work Plan**

Contractor shall prepare and submit a plan describing in detail the approach and methods for prosecuting the work in accordance with the contract. The Management Plan shall include the following:

1. An organizational chart describing:
  - a. The hierarchy and relationship of the Contractor's project staff;
  - b. The hierarchy of subcontractors and suppliers including the trade(s) or portion(s) for which each is responsible; and
  - c. A resume for the proposed Project Manager and/or site superintendent.
2. An address and phone directory of the Contractor, Subcontractor, and priority equipment suppliers.
3. A narrative describing how the Contractor intends to staff, equip, and supply the job by trade in order to meet the contract work sequence and schedule constraints. Include the size of the work crew, description of on-site equipment, working hours, and requirements for material and equipment procurement, lay down, and storage.

4. Provide rates for craft labor likely to be used to complete the Work in accordance with Section 1-07.9(1). At a minimum, provide basic wage and benefits cost, worker's insurance costs, federal insurance costs, safety costs, and travel allowance costs, if applicable. Craft labor cost for the Contractor and all his subcontractors shall be provided.
5. Provide rates for equipment likely to be used to complete the Work. At a minimum, provide complete equipment description, hourly cost, operating cost per hour, and operated cost per hour. Equipment cost for the Contractor and all his subcontractors shall be provided.

### **1-04.3(3) Project Safety and Accident Prevention Program**

Contractor shall prepare and submit a Safety and Accident Prevention Program. This program shall outline the anticipated hazards and safety controls necessary to safeguard Contractor's employees, the public, Kitsap County staff and Kitsap County representatives. It shall be specific to the job and site and meet federal, state and local jurisdictional requirements. The program will be reviewed for compliance with this Section prior to the start of work.

### **1-04.3(4) COVID-19 Health and Safety Plan (CHSP)**

#### **COVID-19 Health and Safety Plan (CHSP)**

The Contractor shall prepare a project specific COVID-19 health and safety plan (CHSP). The CHSP shall be prepared and submitted as a Type 2 working drawing prior to beginning physical Work.

The Contractor shall update and resubmit the CHSP as the work progresses and new activities appear on the look ahead schedule required under Section 1-08.3(2)D. If the conditions change on the project, or a particular activity, the Contractor shall update and resubmit the CHSP. Work on any activity shall cease if conditions prevent full compliance with the CHSP.

The CHSP shall address the health and safety of all people associated with the project including Contractor's employees, Kitsap County staff, Kitsap County representatives, project staff, subcontractors, suppliers and anyone on the project site, staging areas, or yards. The plan shall contain the following minimum elements:

1. The CHSP shall identify all standards, guidance, publications, and sources on which it is based. Those standards may include references to OSHA, WISHA, and CDC publications that are current at the time the CHSP is prepared.
2. The CHSP shall identify a responsible individual from the Contractor who is responsible for implementation of the CHSP. The individual(s) contact information shall be listed in the CHSP.
3. The CHSP shall specifically identify the project for which it is applicable, and if applicable, shall address project work areas outside the project limits such as staging areas or yards.
4. The CHSP shall identify the PPE and administrative and engineered controls necessary to maintain a safe site. This includes but is not limited to: sanitation resources, screening stations, safety briefings, controlling access, and personal protective equipment (PPE) needed to protect workers from COVID-19.
5. The CHSP shall identify measures for screening and managing workers or visitors to areas identified in the CHSP. The plan shall include procedures should a person exhibit symptoms of COVID-19.
6. The CHSP shall identify how the plan will be updated as new work activities are added with each Weekly Look-Ahead schedule. The CHSP updates shall identify the number of workers, crews, work tasks, and the degree of congestion or confinement workers will experience for the work activities in the Weekly Look-Ahead schedule.

7. The CHSP shall include how the Contractor will ensure everyone on the site has been trained on the CHSP requirements. This includes subcontractors, suppliers, and anyone on the project site.

### **COVID-19 Health and Safety Plan (CHSP) Inspection**

The Contractor shall grant full and unrestricted access to the Engineer for CHSP Inspections. The Engineer (or designee) will conduct periodic compliance inspections on the project site, staging areas, or yards to verify that any ongoing work activity is following the CHSP plan. If the Engineer becomes aware of a noncompliance incident either through a site inspection or other means, the Contractor will be notified immediately (within 1 hour). The Contractor will be given 24 hours to either remedy the noncompliance incident or halt the associated work activity. If the Contractor fails to comply within 24 hours of receiving the Engineer's notification, the Engineer may suspend Work. The Contractor must satisfy the Engineer that the noncompliance incident has been corrected before the suspension will end.

### **1-04.3(5) Onsite Investigations**

The Contractor shall perform on-site investigations in support of technical submittal preparation. See Section 1-02.4(2) for additional information. Activities include but may not be limited to the following:

#### **Survey Control**

The Contractor shall establish sufficient survey control to identify vertical and horizontal location of features identified during these on-site investigations. A minimum of two vertical control, temporary benchmarks (TBMs) shall be established for each Schedule for the entire duration of the project. Maintain and place TBMs to prevent disturbance. A registered surveyor employed by the Contractor shall be responsible for setting the TBMs.

#### **Utility Locations**

Perform utility excavations to support collection of the as-built location of existing utilities that may impact or be impacted by the Work under this Contract. Locations of excavations shall be in coordinated and identified jointly by the Contractor and the Construction Manager. Proper equipment, labor, trench support methods, backfill, and asphalt patching materials shall be made available to support the operations. The Contractor shall be prepared to repair any damage caused during exploratory activities. Prior to any utility excavations, provide the Construction Manager advance notice of at least four (4) working days. All information from exploratory excavations shall be submitted to the Construction Manager within two working days after completion of said excavation. See Section 1-07.17 for further information regarding utilities and similar facilities.

### **1-04.3(6) Preconstruction Photographs or Video**

Contractor shall perform preconstruction photo or video documentation in accordance with Section 1-05.4(6) Construction Photographs or Video.

### **1-04.3(7) Submittals**

Prepare and submit the Submittal Control Document in accordance with Section 1-06.1.

Contractor shall provide submittals in accordance with Section 1-06.1 for all priority materials or materials that may take more than six (6) weeks to be obtained. Prior to submission of these priority or long lead time material submittals, Contractor shall attend pre-submittal meetings with the Construction Manager and Design Engineer as deemed appropriate for particular submittals.

#### **Priority Technical Submittals:**

Priority technical submittals have been identified which have an impact on work activities starting immediately following Notice to Proceed for construction. The list includes but may not be limited to the following items. Should the Contractor's schedule identify a critical submittal not listed, preparation and submittal shall be performed during the preconstruction period:

1. Provide an Erosion Control Plan identifying erosion control measures to be used by the Contractor, including those already shown and specified. The Erosion Control Plan shall

- employ best management practices. Refer to requirements in Section 31 25 14 and Section 1-07.15 as amended by the Special Provisions.
2. Provide a Dewatering Plan, including drawings and complete design data showing methods and equipment to be utilized in dewatering, including relief of hydrostatic head, and in maintaining the excavation in a dewatered and in a hydrostatically relieved condition. The Dewatering plan shall address excavation operations for new structures and pipelines and shall comply with Section 31 23 43.
  3. Provide a Sheeting, Shoring, and Bracing Plan. Information to be provided shall be prepared in accordance with Section 31 41 00 and shall, at a minimum, include the following:
    - a. Design calculations and method of installation and removal of all Sheeting, Sheet Piling, Shoring, and Bracing. Calculations shall be made by a Washington State registered structural or civil engineer and shall comply with applicable requirements of the Washington State Safety Code and the rules of the WISHA Department of Labor and Industries with respect to excavation and construction.
    - b. Detailed excavation support drawings.
  4. Provide a Spill Prevention, Control and Countermeasures Plan per Section 1-07.15(1) as amended by the Special Provisions.
  5. Provide Temporary Sewage Bypass Plan(s) in accordance with Section 01 59 00, including drawings and complete design data showing methods and equipment to be utilized to temporarily bypass sanitary sewage systems while making connections to the existing system and/or installing new facilities that require the temporary bypass of the existing facilities.
  6. Provide HDPE pipe submittals in accordance with Section 22 13 10.

**1-04.3(8) Contractor Furnished Permits**

The Contractor shall apply for and obtain the Contractor Furnished Permits per Section 1-07.6(2) during the Preconstruction Work Phase.

**1-04.3(9) Schedules**

The Contractor shall submit the Contractor's scheduling qualifications including the resume(s) of the designated person(s) responsible for schedules and reports (the "Contractor's Scheduler"). The Contractor's Scheduler shall have demonstrable capability to plan, coordinate, execute, and monitor a CPM schedule as required for this Project. The Construction Manager will approve or reasonably disapprove the Contractor's proposed scheduler. In the event of disapproval, a new scheduler shall be proposed within one week and be subject to the same consideration criteria as noted above. In addition, the Contractor shall prepare and submit the following schedule information:

1. Schedule of Values for the lump sum Bid items included in the Bid Proposal.
2. Contractor's Construction Schedule (CPM) prepared in accordance with Section 1-08.3.

**1-04.3(10) Traffic Control Plan(s)**

Contractor shall provide traffic control plan(s) in accordance with Section 1-10.2.

**1-04.3(11) Attend EADOC Training**

Contractor shall attend EADOC training in accordance with Section 1-12.8.

**1-04.3(12) Attend Public Meeting**

Contractor shall attend one evening public meeting during the Preconstruction Work Phase to be introduced to the public that may be impacted by the project and answer general construction related questions.

**1-04.4 Changes**

*The seventh paragraph of Section 1-04.4 is revised to read as follows:  
(Local Agency SP)*

The Contractor shall proceed with the Work upon Receiving:

1. A written change order approved by the Engineer, or
2. A work directive from the Engineer before actually receiving the written change order.

**1-04.4(2) Work Directives**

*Section 1-04.4(2) is added as the following:  
(Local Agency SP)*

Where situations involve changes in the Work that might delay the Project, if not processed expeditiously, the changed work shall be initiated through use of a Work Directive. The Work Directive is not a Change Order, but only a directive issued by the Engineer to proceed with work that may be included in a subsequent Change Order.

The Engineer initiates the form which shall include the project name, number, contract number, and Contractor name. In addition, the reason for the change and a description of the desired Work shall be included in sufficient detail to fully describe the required Work and necessity for the change. A method of payment and estimated cost shall be included along with any modifications to the Contract Time.

Once the Engineer has completed and signed the form, copies of the form and any supporting design criteria, sketches, modified drawings, or specifications attached to the form will be sent to the Contracting Agency's representative for approval. Once authorized by the Contracting Agency's representative, the Work Directive will be forwarded to the Contractor for signature and returned to the Engineer. The Contractor shall then perform the work described in the work directive.

As Work directed by the Work Directive progresses, Contractor shall submit to the Engineer any documentation required by the Work Directive on the day that work is performed for inclusion in a subsequent Change Order. Documentation may include records of force account work, material invoices, as-built data or quality control documentation.

**1-04.4(3) Requests for Information**

*Section 1-04.4(3) is added as the following:  
(Local Agency SP)*

Requests for Information (RFIs) will be used by the Contractor where necessary to provide written direction to clarify or provide additional information or direction regarding the Plans and Specifications. Unless otherwise approved, the Contractor shall use a form provided by the Engineer. While the Engineer will attempt to respond to RFIs in an expeditious manner to avoid impacting the Contract Time, the Engineer shall have a minimum of five (5) working days to review and respond to RFIs. RFIs shall be used if the matter could result in a change in the contract price or time.

**1-04.6 Variation in Estimated Quantities**

Section 1-04.6 is supplemented with the following:  
(Local Agency SP)

For certain items, quantities have been entered into the Bid Proposal only to provide a common Bid Proposal for bidders. Actual quantities will be determined in the field as the work progresses, and will be paid at the original unit bid price, regardless of final quantity. These bid items, identified by the term "allowance" in their title, shall not be subject to the price adjustment provisions of 1-04.6 of the Standard Specifications.

**1-04.11 Final Cleanup**

*Section 1-04.11 is deleted and replaced with the following:  
(Local Agency SP)*

**1-04.11 Cleanup**

The Contractor shall be responsible for ongoing and final cleaning of the project site. The Contractor shall continually, from the first day of work on the project to the last, include in his operations sufficient personnel, equipment, and materials specifically assigned to cleanup all areas which are affected or disturbed by the work operations.

**1-04.11(1) Daily Cleanup**

The Contractor shall cause all disturbed areas to be cleaned of all debris and excess construction materials, to be temporarily or permanently graded and finished to smooth lines and grades, to be maintained free of dust, to control surface runoff such that there is no soil erosion or contaminated runoff onto adjacent areas or drainages, and to not have any detrimental impacts. All such cleanup shall be conducted to the satisfaction of the Contracting Agency.

The Contractor shall clean all roadways, streets, sidewalks, and other facilities of all material and debris that are dropped or otherwise deposited thereon as a result of the Contractor's operations. All such areas shall be cleaned at the conclusion of each day's operations and at such other times as ordered by the Contracting Agency.

In addition, the Contractor shall use water for dust control on paved, surfaced, or unimproved streets or roadways as may be required to prevent inconvenience to the public. The Contractor shall also use water, if necessary, to remove mud and other debris from streets and roadways.

If the roadways and facilities are not properly or promptly cleaned and the conditions so warrant, as determined by Contracting Agency, the Contractor shall provide facilities to remove soil from truck or other equipment tires or between dual wheels or outside of truck beds before trucks or equipment may be allowed to travel over streets.

**1-04.11(2) Final Cleanup**

The Contractor shall perform final cleanup of the project site to the satisfaction of the Contracting Agency after completion of all work and prior to Final Acceptance. The Contracting Agency will not establish the Physical Completion Date until this is done. Such cleanup shall include, but not be limited to, removal of all rubbish, surplus materials, construction materials, equipment, and debris. Oversize rock, stumps, brush, and other extraneous materials shall be removed from the project site and disposed of in a lawful manner.

Roadway surfaces shall be thoroughly broom cleaned and washed to remove all material or debris which was deposited on the surfaces.

Any existing fencing removed or damaged by the Contractor shall be replaced in kind and to the satisfaction of the property owner.

The Contractor shall not remove temporary warning, regulatory or guide signs until authorized to do so by the Contracting Agency.

**1-04.11(3) Corrective Action**

Any violation of the above requirements, as determined by the Contracting Agency, will be sufficient grounds for the Contracting Agency to order the cleanup work to be performed by others. The costs for such corrective action shall be deducted from any monies due or to become due to the Contractor.

**1-04.12 Temporary Facilities**

*Section 1-04.12 is added as the following:  
(Local Agency SP)*

The Contractor shall furnish, for the duration of the project, a temporary field trailer(s) for his use as well as the Contracting Agency's use within a reasonable distance of the project site. Temporary facility installation shall meet the construction safety requirements of OSHA, State, and other governing agencies and the noise limitations shall meet the requirements in Section 1-07.5(5) in the Special Provisions. Contractor shall be responsible for providing telephones, fax machines, and copier and shall pay for installation and monthly service charges for all utilities, including telephone, copy machines, and fax machines. Provide and pay for equipment service contracts for all furnished equipment.

Upon completion of the work, and subject to approval of the Engineer, the Contractor shall completely remove all temporary facilities. Temporary utilities shall be removed to the temporary service connection point, and capped or terminated.

All disturbed surfaces shall be restored to the condition which existed prior to installation of temporary facilities or utilities. All roadway surfaces or other improvements which have been damaged by construction activities shall be repaired or replaced by the Contractor, as directed.

**1-04.12(1) Space Allocation**

On-site space is limited. Arrangements for additional space required for Contractor's staging and storage of materials and equipment (in addition to that allocated), shall be made for locations off site as described below.

Due to the limited space available outside project limits (and within the existing right of way and temporary construction easements), the Contractor shall make the necessary arrangements with nearby property owner(s) in order to establish an area(s) for the temporary facilities and storing of equipment and materials. All costs associated with third parties arrangements shall be considered incidental to the construction and shall be included in the costs of other items of work involved in the project.

**1-04.12(2) Contractor's Work Area**

Contractor shall limit operations and storage of equipment and materials to the areas designated on the Plans, unless written agreements have been obtained from third parties that allow the use of areas outside those described on the Plans. Contractor shall provide a copy of all such third party agreements to the Contracting Agency prior to using areas described by the agreement. All such agreements shall contain provisions that hold the Contracting Agency harmless from any and all damages and costs associated with the use of said areas. Contractor shall be solely responsible for the use of said areas.

Contractor shall maintain the area(s) during construction and shall proceed with the work in an orderly manner, maintaining the construction site free of debris and unnecessary equipment or materials. Material shall be stored on pallets or racks off the ground and in a manner to allow access for inspection.

**1-04.12(3) Temporary Water for Construction and Testing**

Contractor shall be responsible for obtaining a source of temporary water for construction and testing and potable water required by construction personnel. Provide water from off-site sources as necessary. Contractor shall determine availability and make arrangements, and pay all costs, with the local utility for temporary construction water, including metering equipment.

**1-04.12(4) Temporary Electric Power**

Contractor shall verify existing electric service and provide temporary electric power, if required, for use during construction. Electric power should be available at or near the site. The Contractor shall determine the type and amount available and make arrangements with the local utility for obtaining temporary electric power service, including metering equipment. The Contractor shall provide temporary lighting at least to meet all applicable safety requirements to allow erection, application or installation of materials and equipment, and observation or inspection of the Work. Meet safety requirements of OSHA, State and other governing agencies for electrical installations. Facilities for providing temporary electric power shall meet all noise restriction requirements of Section 1-07.5(5) in the Special Provisions.



The Contractor shall provide all electrical power required for construction, testing, general and security lighting, and all other purposes whether supplied through temporary or permanent facilities.

**1-04.12(5) Sanitary Facilities**

The Contractor shall provide suitable chemical toilets or water closets at appropriate locations within the site of the work in compliance with the requirements of Section 1-07.4 of the Standard Specifications. Secondary containment shall be provided for each chemical toilet or water closet. At the end of the job such toilets shall be removed.

**1-04.12(6) Temporary Telephone Service**

Contractor shall furnish onsite telephone service to the temporary field trailer, including fax, for the duration of construction of the Contract and shall be responsible for verifying existing service and making all arrangements with the local telephone utility for providing service as required. Said services shall be provided to the construction trailer(s).

**1.04.12(7) Site Access and Parking**

All vehicles shall be parked in such a manner so as to not encroach on public right-of-way or be a traffic hazard. Ready access to and through the site by emergency vehicles shall be maintained at all times. The Contractor shall be responsible for control of parking by all of the Contractor's and subcontractor's work force to assure compliance. The Contractor shall anticipate that there may not be sufficient parking space for all of the work force in the construction project area. If this is the case, Contractor shall arrange for carpooling and/or off-site parking and shuttle service, as necessary.

**1.04.12(8) Removal of Temporary Facilities**

Upon completion of the work, and subject to approval of the Engineer, the Contractor shall completely remove all temporary facilities. Temporary utilities shall be removed to the temporary service connection point, and capped or terminated.

All disturbed surfaces shall be restored to the condition which existed prior to installation of temporary facilities or utilities. All roadway surfaces or other improvements which have been damaged by construction activities shall be repaired or replaced by the Contractor, as directed.

**END OF SECTION 1-04**

THIS PAGE INTENTIONALLY LEFT BLANK

**1-05 Control of Work****1-05.2 Authority of Assistants and Inspectors**

*Section 1-05.2 is supplemented with the following:  
(Local Agency SP)*

The Contracting Agency or the Contracting Agency's Representatives shall have the right to inspect and obtain copies of all written licenses, permits, or approvals issued by any governmental entity or agency to the Contractor, its delegates, or subcontractors, which are applicable to the performance of this Contract, and to inspect all Work and Materials for conformity with the Contract terms. The Contractor shall be responsible for ensuring the Work and materials conform to the Contract terms even if the Contracting Agency or the Contracting Agency's Representative conducts any inspection of the same.

**1-05.4 Conformity With and Deviations from Plans and Stakes**

*Section 1-05.4 is supplemented with the following:  
(Local Agency SP)*

**1-05.4(1) Contracting Agency-Furnished Reference Points and Surveying**

The Contracting Agency has established survey control for construction purposes. This survey control information is provided on the drawings.

The Contractor shall protect and preserve survey control points and property corners. If these points or corners are disturbed by the Contractor, the Contractor shall pay all costs associated for re-establishment of the control points and property corners. The Contractor shall have the work performed by the Contractor's surveyor. Delays resulting from the destruction and re-establishment of survey control points and property corners shall not constitute the basis for additional compensation or extensions to the Contract Time.

**1-05.4(2) Contractor-Furnished Surveying**

The Contractor shall provide all necessary construction surveys to complete the Work as required by the Contract Documents. The Contractor shall use competent and experienced survey personnel, and suitable equipment necessary for establishing, checking, and maintaining points, lines and grades. Survey shall provide sufficient alignment and off-set control points for proper vertical and horizontal alignment, grade, station and construction of the facilities. In addition, the center point and/or corners of all structures shall be staked. Survey work shall be within the following tolerances:

- |    |                     |               |
|----|---------------------|---------------|
| 1. | Stationing,         | +/- 0.01 feet |
| 2. | Alignment           | +/- 0.01 feet |
| 3. | Structure elevation | +/- 0.01 feet |

Contractor shall employ or retain a registered Washington Land Surveyor to perform and/or oversee and direct construction surveys, as well as surveys to verify/document locations and elevations of all completed facilities for record drawings. Minor surveying, such as grade staking may be performed by the Contractor's personnel with approval of the Engineer. Contractor shall be responsible for detailed dimensions, elevations, and excavation measured from the construction staking.

The Engineer may verify the Contractor's work with spot-checks. These spot-checks do not change the requirements for normal checking and testing as specified elsewhere or the Contractor's responsibility for the work and producing a finished product that is in accordance with the Contract Documents. If errors are found, the Contractor shall correct the errors, which may include removal and replacement of incorrectly installed improvements. All costs in correcting work shall be at the Contractor's expense in accordance with Section 1-05.7.

In the event the Engineer determines the survey work is insufficient, the Contractor shall provide suitable and acceptable corrective measures immediately at no additional expense to the Contracting Agency.

The Contractor shall perform preconstruction survey of roads (i.e., WSDOT SR 308, SR 3, Brownsville Hwy, Tagholm Rd) to be affected by the work. Preconstruction survey shall be performed in accordance with Section 1-05.4. The Contractor's preconstruction survey of roads shall be the basis for restoring the affected roads to existing lines and grades and in-kind restoration of pavement markings. Prior to the Contractor beginning the work, the construction manager and engineer will review, for approval, the roads preconstruction survey.

**1-05.4(3) Survey Submittals**

Contractor shall submit the qualifications and resume(s) of the proposed survey firm and surveyor(s) along with a description of the survey efforts to be performed. Cut-sheets shall be provided to the Engineer for review a minimum of five (5) working days in advance of construction.

**1-05.4(4) Survey Records**

Field books shall be hard-back field books, such as K&E 82-0056 or similar. The Contractor shall maintain on-site a copy of all field surveying records prepared by surveyor. These records shall be available for review by the Engineer upon request. At the conclusion of the work, the Contractor shall provide the Contracting Agency with a copy of the surveying records.

**1-05.4(5) Resurveys**

The Contractor shall direct all questions regarding interpretation of provided survey data to the Engineer. Failure to correctly interpret and utilize survey control data or plans as provided by the Engineer shall not constitute justification for a claim of extra work. The Contractor shall immediately notify the Engineer of any survey data discrepancies.

Any claim by the Contractor for extra compensation by reason of alterations or reconstruction work allegedly due to error in Contracting Agency-Furnished survey control, will not be allowed unless the original control points still exist and are proven to be incorrect, or unless other satisfactory substantiating evidence to prove the error is furnished to the Engineer.

**1-05.4(6) Construction Photographs or Video**

Prior to and after construction, the Contractor shall provide still photographs, or alternatively, audio color video of project area and adjacent site conditions. Filming plan shall be coordinated with the Contracting Agency's Representative. Filming shall be done at reasonable intervals along the project so sufficient detail and coverage of the area is provided (e.g. approximately every 100 feet, intersections, staging areas, pump station sites, etc). Filming shall be done from differing directions, spacing, and angles to sufficiently show/depict the project area's conditions.

Photographs shall be done by a qualified commercial professional photographer. Photos shall be taken with a high-quality digital camera, with minimum 8-mega-pixel resolution.

Photographs shall be 3-inch by 5-inch color matte prints mounted on 8-1/2" by 11" cardstock, enclosed within plastic film folders, or other approved mounting. Pictures shall be logically arranged and bound in a 3-ring D binder. Photographs shall also be provided on CDs with an index correlated with the mounted prints. Pictures shall have the date, location, description, direction of filming and other pertinent reference information (e.g., facing east, facing south, etc.) on or below each image. Submit sample for review and approval in advance of producing bound document.

Video shall be done by qualified commercial professional photographer. Video equipment shall be a high quality digital recorder. The video shall contain an audio track which narrates the progression of the video through the project area/site. Recording shall display index counter, date and time of recording.

The pre-construction photographs or video shall be performed prior to commencement of the work and after initial staking of the project and construction limits. Post construction photographs shall be taken at final completion of the work. Post construction filming locations shall be similar to preconstruction filming locations. Submit 1 copy of photographs and CDs to the Engineer.

**1-05.4(7) Existing Markers and Monuments**

Contractor shall take necessary precautions to locate and protect existing markers, property corners, monuments, section corners, subdivision corners, plat markers, bench marks, and all other reference points that may be affected by construction. All markers that may be disturbed by construction shall be identified, referenced, and replaced if disturbed in accordance with recognized surveying practices. Property corners, fences and other indications of property lines shall be referenced by the Contractor prior to construction and reset after completion of the construction operations in accordance with recognized survey practices.

Contractor shall not knowingly remove or disturb any such marker before a licensed land surveyor can reference such marker. Contractor shall be responsible for providing said survey services and shall be responsible for all costs for replacing markers and recording of surveys. Contractor will not be entitled to any delay costs for referencing an existing marker.

In the event that any of these items are not replaced by the Contractor, they shall be replaced by Engineer and the cost of this work shall be billed to the Contractor by the Contracting Agency.

**1-05.4(8) Re-establishment of Existing Markers and Monuments**

If a marker or monument must be disturbed, Contractor shall follow these steps in accordance with recognized survey practices:

1. Survey work associated with WAC 332-120 shall be performed for the removal and resetting of monuments.
2. Before Contractor disturbs monument(s), surveyor shall establish reference points to perpetuate the position of the monument(s) and an Application For Permit to Remove or Destroy a Survey Monument shall be filed with the Department of Natural Resources (DNR) as set forth in WAC 332-120, for all existing monuments that are subject to being disturbed, prior to construction of improvements.
3. Once a permit has been authorized by DNR, the Contractor may excavate monument(s).
4. The Contractor shall provide replacement monuments as shown on the Plans or as required by the County.
5. The Contractor shall set replacement monument, case, and cover in position.
6. Surveyor shall verify the position and punch mark the brass cap.
7. Surveyor shall file Completion Report for Monument Removal and Destruction with the Department of Natural Resources upon completion of monument replacement.

The Contractor shall be responsible for removal and resetting of markers and monuments.

**1-05.5 Project Record Drawings**

*Section 1-05.5 is added as the following:  
(Local Agency SP)*

The Contractor shall maintain two sets of full size drawings and specifications for the Contract on site during the construction that shall be accessible for review by the Contracting Agency and the Engineer at all times. The Contractor's superintendent or authorized representative shall update the documents with clear and accurate red-lined field revisions and record information on a daily basis and within two (2) business days after receipt of information that a change in Work has occurred. The quality of the Record Drawings, in terms of accuracy, clarity, and completeness, shall be adequate to allow the Contracting Agency to modify the computer-aided drafting (CAD) Contract Drawings to produce a complete set of Record Drawings for the Contracting Agency without further investigative effort by the Contracting Agency.

The Record Drawing markups shall document all changes in the Work, both concealed and visible and shall be legible and accurately marked to indicate modifications in the completed work that differ from the design information shown on the Contract Plans. The Contractor shall not conceal any Work until the

required information is recorded. Items that must be shown on the markups include, but are not limited to:

1. Actual dimensions, arrangement, and materials used when different than shown in the Plans.
2. Changes made by Change Order or Work Directive.
3. Changes made by the Contractor.
4. Accurate locations of storm sewer, sanitary sewer, water mains, and other water appurtenances, underground power and telephone, gas lines, structures, conduits, light standards, vaults, width of roadways, sidewalks, landscaping areas, building footprints, channelization and pavement markings, etc. Include pipe invert elevations, top of castings, (manholes, inlets, etc.).

As-built surveying/staking provided by the Contractor shall meet the following tolerance limits:

	<u>Vertical</u>	<u>Horizontal</u>
As-built sanitary & storm invert and grate elevations	± 0.01 foot	± 0.01 foot
As-built monumentation	± 0.001 foot	± 0.001 foot
As-built waterlines, inverts, valves, hydrants	± 0.10 foot	± 0.10 foot
As-built ponds/swales/water features	± 0.10 foot	± 0.10 foot
As-built buildings (fin. Floor elev.)	± 0.01 foot	± 0.10 foot
As-built gas lines, power, TV, Tel, Com	± 0.10 foot	± 0.10 foot
As-built signs, signals, etc.	N/A	± 0.10 foot

Redline entries on the Record Drawings shall conform to the following standard:

1. Use erasable colored pencil (not ink) for all markings on the Record Drawings, conforming to the following color code:
2. Additions - Red
3. Deletions - Green
4. Comments - Blue
5. Dimensions - Graphite
6. Provide the applicable reference for all entries, such as the change order number, the request for information (RFI) number, or the approved shop drawing number.
7. Date all entries.
8. Clearly identify all items in the entry with notes similar to those in the Contract Drawings (such as pipe symbols, centerline elevations, materials, pipe joint abbreviations, etc.).

The Record Drawings shall be used for this purpose alone, shall be kept separate from other Plan sheets, and shall be clearly marked as Record Drawings. One set shall be submitted to the Engineer monthly along with the Contractor's request for progress payments. Failure to supply the record drawings each month or failure of the record drawings to reflect the above information in a clear and concise manner shall be basis for withholding the Contractor's Progress Payments until such time as they are completed to the satisfaction of the Engineer. Upon completion of review of the drawings, the Engineer shall either return the set of record drawings to the Contractor for continued use or may provide a new, unused set of documents for the Contractor's use.

Upon completion of all the work and prior to final acceptance, one or both of the sets of record drawings and specifications shall be delivered to the Engineer along with a copy of all supporting information. The

Contractor shall certify on the Record Drawings that said drawings are an accurate depiction of built conditions, and in conformance with the requirements detailed above.

#### **1-05.5(1) Project Electronic Data and Information**

Electronic submittals shall conform to Section 1-12. This may include RFIs, Work Directives, Project Data Submittals/Shop Drawings, and other project correspondence. Protocol and requirements shall be discussed and worked out with the Contracting Agency and Engineer in advance. Electronic data and information shall be in a PDF format that conforms to Section 1-06.1(3). Due to security and other IT system constraints, file sizes may be limited. Contractor shall provide paper copies at the request of the Contracting Agency or Engineer.

Once the Contract is awarded, the Contracting Agency will grant the Contractor access to their EADOC software for the Contractor's use on this project. No user fees will be charged to the Contractor for this software. All costs for the training and use of this software shall be considered incidental to the Contract.

#### **1-05.7 Removal of Defective and Unauthorized Work**

*Section 1-05.7 is supplemented with the following:  
(October 1, 2005 APWA GSP)*

If the Contractor fails to remedy defective or unauthorized work within the time specified in a written notice from the Engineer, or fails to perform any part of the work required by the Contract Documents, the Engineer may correct and remedy such work as may be identified in the written notice, with Contracting Agency forces or by such other means as the Contracting Agency may deem necessary.

If the Contractor fails to comply with a written order to remedy what the Engineer determines to be an emergency situation, the Engineer may have the defective and unauthorized work corrected immediately, have the rejected work removed and replaced, or have work the Contractor refuses to perform completed by using Contracting Agency or other forces. An emergency situation is any situation when, in the opinion of the Engineer, a delay in its remedy could be potentially unsafe, or might cause serious risk of loss or damage to the public.

Direct or indirect costs incurred by the Contracting Agency attributable to correcting and remedying defective or unauthorized work, or work the Contractor failed or refused to perform, shall be paid by the Contractor. Payment will be deducted by the Engineer from monies due, or to become due, the Contractor. Such direct and indirect costs shall include in particular, but without limitation, compensation for additional professional services required, and costs for repair and replacement of work of others destroyed or damaged by correction, removal, or replacement of the Contractor's unauthorized work.

No adjustment in contract time or compensation will be allowed because of the delay in the performance of the work attributable to the exercise of the Contracting Agency's rights provided by this Section.

The rights exercised under the provisions of this section shall not diminish the Contracting Agency's right to pursue any other avenue for additional remedy or damages with respect to the Contractor's failure to perform the work as required.

#### **1-05.8 Coordination with Owner and Adjacent Homes**

*Section 1-05.8 is added as the following:  
(Local Agency SP)*

Access to homes and business shall be maintained at all times. To maintain access to homes and businesses during the contract, the contractor shall observe the following requirements:

1. Post signs and notify homes and businesses at least five (5) working days ahead of any construction that may impact their access.
2. Provide alternate access as required to affected homes and businesses.
3. Provide a Traffic Control Plan prior to construction as described in Section 1-10 and keep it updated as construction progresses.

Maintaining access to homes and businesses shall be considered incidental to the Contract and included in other bid items. No separate payment shall be made.

**1-05.10 Guarantees**

*Section 1-05.10 is deleted and replaced with the following:  
(Local Agency SP)*

In addition to any special warranties provided elsewhere in the Project Documents, the Contractor warrants to the Contracting Agency that materials and equipment furnished under the Contract will be of good quality and new unless otherwise required or permitted by the Project Documents, and that the Work will conform to the requirements of the Project Documents as described herein. Work not conforming to these requirements, including substitutions not properly approved and authorized, may be considered defective and may be rejected. The Contractor's warranty excludes remedy for damage caused by abuse, improper or insufficient maintenance, or improper operation. If required by the Contracting Agency's Representative or Contracting Agency, the Contractor shall furnish satisfactory evidence as to the kind and quality of materials and equipment provided.

Neither final acceptance by the Contracting Agency nor partial and final payment nor any provision in the Contract Documents shall relieve the Contractor of responsibility for faulty materials or workmanship.

If, prior to the expiration of one year after the date of final acceptance of all work or such longer period of time as may be prescribed by law or by the terms of any applicable special guarantee required by the Contract Documents, any work (including materials and equipment) that is found to be defective or not in compliance with the Contract Documents, the Contractor shall promptly, without cost to Contracting Agency, either correct such work, or, if it has been rejected by Contracting Agency, remove and replace it with acceptable work. If the Contractor does not promptly comply with the notification issued by the Contracting Agency for correction of defective and/or non-complying work, the Contracting Agency may have the Work corrected or removed and replaced and all direct and indirect costs of such removal and replacement, including costs of all professional services, shall be paid by Contractor as provided for herein.

Actual or alleged knowledge by the Contracting Agency, Engineer and/or inspector(s), prior to acceptance of all work by the Contracting Agency, of defects or deficiencies in the Work shall not, in any way, affect or diminish the guarantee by the Contractor. The guarantee shall apply to all elements and parts of the Work, regardless of knowledge by the Contracting Agency, Engineer and inspector(s) of defects or deficiencies and regardless of failure of the Contracting Agency, Engineer and/or inspector(s) to inform the Contractor of known or suspected defects or deficiencies prior to final acceptance of the Work by the Contracting Agency.

All subcontractor's, manufacturers', and suppliers' warranties and guarantees, express or implied, for any part of the Work, materials and equipment shall be deemed obtained and shall be enforced by the Contractor for the benefit of the Contracting Agency without the necessity of formal transfer or assignment thereof. Warranties and guarantees by subcontractors, manufacturers, and suppliers shall begin on and extend for one year after the date of final acceptance by the Contracting Agency of all work.

All work (including materials and equipment) repaired or replaced in accordance with this Section shall be guaranteed for a period of one year after the date of acceptance by the Contracting Agency of the repair/replacement work.

Nothing contained in these provisions shall defeat or impair the right of persons furnishing materials or labor to recover under any bond given by the Contractor for their protection, or any rights under any law permitting such persons to look to funds due the Contractor in the hands of the Contracting Agency.

These guarantee provisions shall be inserted in all subcontracts and material contracts, and notice of these provisions shall be given to all persons furnishing materials for the Work when no formal contract is entered into for such materials.



**1-05.11 Final Inspection**

*Section 1-05.11 is deleted and replaced with the following:  
(Local Agency SP)*

**1-05.11 Facility Startup, Testing and Training**

Contractor shall provide complete startup and testing/commissioning to ensure that equipment and mechanical, electrical, controls and special controls and instrumentation systems are properly installed and function, operate, and perform as intended and required. Contractor shall submit a startup and testing plan showing how the testing will be accomplished for review and acceptance by the Engineer prior to commencing startup and testing of the facilities.

All mechanical and electrical equipment shall be tested by the Contractor before any system is put into operation. Testing procedures shall be designed to duplicate as nearly as possible all conditions of operations and shall be carefully selected to ensure that the equipment is not damaged. Tests shall be as specified herein and shall be made to determine whether the equipment has been properly assembled, aligned and connected. Any changes, adjustments or replacements required to make the equipment operate as required shall be carried out by the Contractor or a qualified technician of the seller or equipment representative as part of the work.

Before startup, the Contractor shall properly lubricate all bearings and other items which normally require lubrication and fill each gear case and oil reservoir to the proper operating level, using the equipment manufacturer's supplied lubricant. If any equipment or system does not operate properly, the Contractor shall immediately replace or repair components until it operates properly. When the equipment start-up is complete, the Contractor shall submit a start-up and testing report to the Engineer.

Copies of field test reports shall be signed by the Contractor and provided to the Engineer along with the testing report.

Initial startup and testing or commissioning services shall include a minimum of one (1) 8-hour day(s).

System Startup and Testing General Requirements shall include the following:

1. Following initial startup and testing, the entire system shall be required to undergo a 10-day startup period in the presence of the Contracting Agency and Engineer. Any equipment failing or malfunctioning during this 10-day period shall be repaired or replaced, and when it is once again operational, shall be required to undergo a full 10-day startup period. Acceptance of the work and equipment will occur only after successful completion of the 10-day startup period.
2. The Contractor will supervise and be responsible for the proper maintenance and care of the equipment during the startup period and a succeeding 10-day period after successful startup.
3. When a motor, pump, valve, meter, instrument, or other item of equipment does not operate properly, adjustments shall be made by an experienced technical representative of the manufacturer.
4. If adjustments fail to correct the operation of a piece of equipment, remove and replace it with a suitable replacement that meets the operating requirements.

All components shall be calibrated by the Contractor after completion of installation. Components that cannot be properly calibrated or are found to exceed the specified range or accuracy shall be removed and replaced.

Contractor is responsible for determining that all equipment and all systems are functioning properly by start-up time. Prior to startup, the Contractor shall furnish documentation that the equipment provided is installed and is functioning in compliance with the manufacturer's recommended specification and instructions.

The Contractor shall anticipate that the Contracting Agency may delay acceptance of all work under the Contract if, in the judgment of the Contracting Agency, malfunctions or failures in operation of the system

repeatedly occur after startup. The Contractor shall not be entitled to an extension of time or to any claim for damages because of hindrances, delays, or complications caused by or resulting from delay by the Contracting Agency in accepting the work because of malfunctions or failures in operation of the system.

Immediately prior to final acceptance, Contractor shall make a final check of all lubrication requirements and leave all equipment properly lubricated, ready for Contracting Agency's use.

The Contractor shall demonstrate to the Contracting Agency's personnel, the proper manner of maintaining the equipment, making adjustments, and maintaining the system. Work performed by the manufacturer's representative required for startup will not be considered as operator training even if the operators are present and witnessing the adjustments. Equipment startup will be completed before the required on-the-job operator training begins. Operator training services shall include a minimum of two (2) 8-hour days.

#### **1-05.11(1) Substantial Completion**

When the Contractor considers the work to be substantially complete, the Contractor shall so notify the Engineer and request the Engineer establish the Substantial Completion Date. The Contractor's request shall list the specific items of work that remain to be completed in order to reach physical completion. The Engineer will schedule an inspection of the work with the Contractor to determine the status of completion and prepare a punch list of unresolved items. If the number of unresolved items exceeds 20, the Engineer may stop the inspection and notify the Contractor that the project is not ready for the Substantial Completion Inspection. The list of unresolved items shall be provided by the Engineer to the Contractor within 10 working days of the Contractor's request for Substantial Completion. The Engineer may also establish the Substantial Completion Date unilaterally. The Contractor will not be allowed an extension of contract time because of a delay in the performance of the work attributable to the exercise of the Engineer's right hereunder.

If the Engineer concurs with the Contractor that the work is substantially complete and the facilities can be used safely and are ready for the intended use, the Engineer, by written notice to the Contractor, will set the Substantial Completion Date. If, after this inspection the Engineer does not consider the work substantially complete and ready for its intended use, the Engineer will, by written notice, so notify the Contractor giving the reasons therefore.

Upon receipt of written notice concurring in or denying substantial completion, whichever is applicable, the Contractor shall pursue vigorously, diligently and without unauthorized interruption, the work necessary to reach Substantial and Physical Completion. The Contractor shall provide the Engineer with a revised schedule indicating when the Contractor expects to reach substantial and physical completion of the work.

The above process shall be repeated until the Engineer establishes the Substantial Completion Date and the Contractor considers the work physically complete and ready for final inspection.

#### **1-05.11(2) Operational Testing**

It is the intent of the Contracting Agency to have a complete and operable system prior to establishing the Substantial Completion Date. Therefore, when the work involves the installation of process, mechanical and electrical systems, the Contractor will be required to operate and test these systems for a period of time prior to the Substantial Completion Date. Process and mechanical equipment, electrical controls, meters, or other devices and equipment to be tested during this period, shall be tested under the observation of the Contracting Agency or Engineer. Where such operational testing is required, the systems shall be tested under operating conditions for a reasonable period of time, but no less than the number of days stipulated, to assure their proper operation and function prior to establishing the Substantial Completion Date. During and following the test period, the Contractor shall correct any items of workmanship, materials, or equipment which do not meet the requirements of the Contract Documents, prove faulty, or that are not in good operating condition. Equipment that repeatedly breaks down or fails to operate or perform properly during this operational testing period will be cause to extend the testing period. The Substantial Completion Date will not be established until the necessary corrections and tests have been completed to the satisfaction of the Engineer and Contracting Agency.

The costs for equipment, labor, materials, supplies, power, gas, water, and everything else needed to successfully complete operational testing shall be included in the unit contract prices related to the system being tested, unless specifically set forth otherwise in the proposal.

Operational and test periods shall not affect a manufacturer's guaranties or warranties furnished under the terms of the contract.

### **1-05.11(3) Final Inspection and Physical Completion**

When the Contractor considers the work physically complete and ready for final inspection, the Contractor, by written notice, shall request the Engineer to schedule a final inspection. The Engineer will set a date for final inspection. The Engineer and the Contractor will then make a final inspection and the Engineer will notify the Contractor in writing of all particulars in which the final inspection reveals the work incomplete or unacceptable. If the number of unresolved items exceeds 20, the Engineer may stop the inspection and notify the Contractor that the project is not ready for the Physical Completion Inspection.

The Contractor shall immediately take such corrective measures as are necessary to remedy the listed deficiencies. Corrective work shall be pursued vigorously, diligently, and without interruption until physical completion of the listed deficiencies. This process will continue until the Engineer is satisfied the listed deficiencies have been corrected.

If action to correct the listed deficiencies is not initiated within 7 days after receipt of the written notice listing the deficiencies, the Engineer may, upon written notice to the Contractor, take whatever steps are necessary to correct those deficiencies pursuant to Section 1-05.7.

The list of unresolved items shall be provided by the Engineer to the Contractor within 10 working days of the Contractor's request for Physical Completion. The Contractor will not be allowed an extension of contract time because of a delay in the performance of the work attributable to the exercise of the Engineer's right hereunder.

Upon correction of all deficiencies, the Engineer will notify the Contractor and the Contracting Agency, in writing, of the date upon which the work was considered physically complete. That date shall constitute the Physical Completion Date of the contract, but shall not imply acceptance of the work or that all the obligations of the Contractor under the contract have been fulfilled.

### **1-05.12 Final Acceptance**

*The first paragraph of Section 1-05.12 is deleted and replaced with the following:  
(Local Agency SP)*

The Contractor must perform all the obligations under the contract before a completion date and final acceptance can occur. Failure of the Contractor to perform all the obligations under the contract shall not bar the Contracting Agency from unilaterally accepting the contract as provided in Section 1-09.9. The Contracting Agency, or a duly authorized representative, accepts the completed contract and the items of work shown in the Comparison of Quantities by signature of the Notice of Completion and Acceptance. The date of that signature constitutes the acceptance date. Progress estimates or payments shall not be construed as acceptance of any work under the contract.

### **1-05.12(1) One-Year Guarantee Period**

*Section 1-05.12(1) is added as the following:  
(Local Agency SP)*

The Contractor shall return to the project and repair or replace all defects in workmanship and material discovered within one year after Final Acceptance of the Work, except that the submersible pumps' guarantee shall be for five years as stipulated in Section 22 13 29.16 of these specifications. The Contractor shall start work to remedy any such defects within 7 calendar days of receiving Contracting Agency's written notice of a defect, and shall complete such work within the time stated in the Contracting Agency's notice. In case of an emergency, where damage may result from delay or where loss of services may result, such corrections may be made by the Contracting Agency's own forces or another contractor, in which case the cost of corrections shall be paid by the Contractor. In the event the

Contractor does not accomplish corrections within the time specified, the work will be otherwise accomplished and the cost of same shall be paid by the Contractor.

When corrections of defects are made, the Contractor shall then be responsible for correcting all defects in workmanship and materials in the corrected work for one year after acceptance of the corrections by Contracting Agency.

This guarantee is supplemental to and does not limit or affect the requirements that the Contractor's work comply with the requirements of the Contract or any other legal rights or remedies of the Contracting Agency.

#### **1-05.13 Superintendents, Labor and Equipment of Contractor**

*Delete the sixth and seventh paragraphs of Section 1-05.13 is revised to read as follows:  
(August 14, 2013 APWA GSP)*

#### **1-05.13(1) Emergency Contact List**

The second sentence in the first paragraph of Section 1-05.13(1) is revised to read as follows:  
(Local Agency SP)

The list shall include, at a minimum, the Prime Contractor's Project Manager, or equivalent, the Prime Contractor's Project Superintendent, and the Certified Erosion and Sediment Control (CESCL) Lead.

#### **1-05.14 Cooperation with Other Contractors**

*Section 1-05.14 is supplemented with the following:  
(Local Agency SP)*

The Contractor shall not cause unnecessary hindrance or delay to others working in the project area. If the performance of any contract for the project is likely to be interfered with by the simultaneous performance of other contracts, the Contracting Agency and Engineer will decide which Contractor shall cease work temporarily and which Contractor shall continue, or whether the work under the contracts can be coordinated so that the contractors may proceed simultaneously.

On questions concerning conflicting interest of contractors performing related work, the decision of the Contracting Agency and Engineer shall be binding upon all contractors concerned and the Contracting Agency, the Engineer, the Contracting Agency's Representative, and their consultants shall not be responsible for damages suffered or extra costs incurred by the Contractor resulting directly or indirectly from the award, performance, or attempted performance of other contracts in the project area or caused by a decision or omission of the Contracting Agency and Engineer regarding the order of precedence in the performance of the contracts.

If, through acts of neglect on the part of the Contractor, other parties suffer loss or damage in their Work, the Contractor agrees to settle with such others by agreement or arbitration, if such others will so settle. If such others assert any claim against the Contracting Agency, the Engineer, the Contracting Agency's Representative, or their consultants on account of damage alleged to have been so sustained, the Contracting Agency shall notify the Contractor, who shall hold harmless, indemnify, and defend the Contracting Agency, Engineer, the Contracting Agency's Representative, and their consultants, and each of their directors, officers, employees, and agents against any such claim, including all attorney's fees and any other costs incurred by the indemnified parties relative to any such claim.

The Contractor shall coordinate his work with other contractors, public agencies, property owners, and utility companies which may have facilities or be working in the project area to minimize mutual interference. The Contractor shall cooperate with the utility companies and/or their subcontractors and conduct his operations in a manner that the necessary construction of their facilities can be accomplished to the mutual satisfaction of the Contracting Agency and the utility companies.

He shall also coordinate his activities with the Contracting Agency; and no water or sewer mains, individual water or sewer services, street, or private driveways may be closed off without a minimum five (5) working days notice to the Contracting Agency and the private property owner. Should the property owner or the Contracting Agency have reasonable reason, as determined by the Engineer, to avoid

access or water or sewer service shutoff at the scheduled time, the Contractor shall reschedule his work to meet the new condition.

The Contractor shall maintain overall coordination for the execution of the work. Based on the Construction Schedule prepared in accordance with these Specifications, the Contractor shall obtain from each subcontractor a similar schedule and shall be responsible for all parties maintaining these schedules or for coordinating required modifications.

**1-05.15 Method of Serving Notices**

*The second paragraph of Section 1-05.15 is revised to read as follows:  
(March 25, 2009 APWA GSP)*

All correspondence from the Contractor shall be directed to the Project Engineer. All correspondence from the Contractor constituting any notification, notice of protest, notice of dispute, or other correspondence constituting notification required to be furnished under the Contract, must be in paper format, hand delivered or sent via mail delivery service to the Project Engineer's office. Electronic copies such as e-mails or electronically delivered copies of correspondence will not constitute such notice and will not comply with the requirements of the Contract.

**END OF SECTION 1-05**

THIS PAGE INTENTIONALLY LEFT BLANK

**1-06 Control of Materials****1-06.1 Approval of Materials Prior to Use**

*Section 1-06.1 and its associated subsections are deleted and replaced with the following:  
(Local Agency SP)*

All equipment, materials, and articles incorporated into the permanent work:

1. Shall be new, unless the Special Provisions permit otherwise;
2. Shall meet the requirements of the Contract Documents including DOE SRF Specification Insert, and be reviewed by the Engineer prior to use;
3. May be inspected or tested at any time during their preparation and use; and
4. Shall not be used in the work if they become unfit even after being previously approved.

Prior to use, the Contractor shall assemble and submit to the Contracting Agency, Project Data and Shop Drawings for all proposed materials. The Contractor shall prepare and update on at least a monthly basis a submittal control document that indicates the status of all submittals. The status report shall be initially developed to identify all shop drawing and submittal data to be assembled and submitted by Contractor for Engineer's review.

The Contractor is cautioned that equipment and materials for which submittals are required, and which are constructed, installed, or incorporated prior to Engineer's review is at Contractor's risk. Such equipment or materials may be rejected by the Contracting Agency, and if rejected, shall be removed and replaced by the Contractor if so ordered by the Engineer at the Contractor's expense.

**American Iron and Steel**

The DCIP grant has special conditions including compliance with the Buy American Act (BAA). The Contract Specifications did include a "Domestic preferences for procurements" clause under Section SP-02 "Grant Requirements" as part of the Special Provisions. The BAA is defined under Title 41, Chapter 83 of the United States Code (U.S.C.) and is generally described as the requirement or preference for the purchase or acquisition of goods, products, or materials produced in the United States, including iron, steel, and manufactured goods.

"Buy American;" requires all iron and steel products used in the project be produced in the United States (American Iron and Steel Requirements). The act defines iron and steel products as, "...the following products made primarily of iron or steel: lined or unlined pipes and fittings, manhole covers and other municipal castings, hydrants, tanks, flanges, pipe clamps and restraints, valves, structural steel, reinforced precast concrete, and construction materials."

The contractor hereby represents and warrants to and for the benefit of the project owner and the state that:

- a) The contractor has reviewed and understands the American Iron and Steel Requirements,
- b) All of the iron and steel products used in the project will be and/or have been produced in the United States in a manner that complies with the American Iron and Steel Requirements, unless a waiver of the requirements is approved, and
- c) The contractor will provide any further verified information, certification or assurance of compliance with this paragraph, or information necessary to support a waiver of the American Iron and Steel Requirements, as may be requested by the project owner or the state.

Notwithstanding any other provisions of this agreement, any failure to comply with this paragraph by the contractor shall permit the project owner or state to recover as damages against the contractor any loss, expense or cost (including without limitation attorney's fees) incurred by the project owner or state

resulting from any such failure (including without limitation any impairment or loss of funding, whether in whole or part, from the state or any damages owed to the state by the project owner). While the contractor has no direct contractual obligation with the state, as a lender to the project owner for the funding of its project, the project owner and the contractor agree that the state is a third-party beneficiary and neither this paragraph nor any other provision of the agreement necessary to give this paragraph force or effect shall be amended or waived without the prior written consent of the state.

#### **1-06.1(1) Contractor Responsibility for Submittals**

The Contract Drawings were developed to provide a general description of the work. These drawings do not and are not intended to provide all the details of each and every element of the work. The Contractor shall be responsible for, and prepare (or have prepared), all shop and working drawings required to supplement the Contract Drawings to establish the necessary details for construction.

Supplemental shop and working drawings shall be prepared by the Contractor as required by these Special Provisions. Supplemental shop and working drawings shall include, but not be limited to: metal fabrication plans and details, erection plans and details, masonry layout plans and details, reinforcing steel plans and details, shoring plans and details, concrete formwork plans and details, equipment installation plans and details, piping layout and support plans and details. The Contractor shall be fully and completely responsible for the accuracy of the dimensions and details of the supplemental shop and working drawings, including those prepared by subcontractors, suppliers, and detailers and for full and complete conformity with the defined and implied intent of the Contract Documents. The Contractor shall check all shop drawings to make sure they conform with the Contract Documents, and in the case of re-submittals, that all review comments have been addressed prior to transmittal.

The Contractor shall coordinate between suppliers to verify that equipment, mechanical, electrical, structural elements, and other parts of the work correctly interface. The Contractor shall check and verify field dimensions of new and existing work as needed to ensure that shop drawings and other submittals are correctly dimensioned. Catalog cut sheets shall be clearly marked or notated as to which items are intended to be supplied. The Contractor's shop drawings and submittals that have been carelessly or improperly prepared and clearly not reviewed by the Contractor will be returned un-reviewed.

The Contractor shall prepare and timely transmit submittals so as not to delay the construction schedule. The Contractor is responsible for the timeliness of submittals prepared by his suppliers and subcontractors. The Contractor shall anticipate the time required for review and possible re-submittals, and shall include reasonable amounts of time for preparation, distribution and review of submittals in the construction schedule. The Contracting Agency and Engineer shall process submittals expeditiously and endeavor to complete reviews as quickly as possible, but is under no obligation to waive procedures or expedite processing because of untimely submittals by the Contractor.

By approving and submitting shop drawings, product data and samples, the Contractor represents that he/she has determined and verified all materials, field measurements, and field construction criteria related thereto, and that he/she has checked and coordinated the information contained within such submittals with the requirements of the work and Contract Documents, including with associated subcontractors, and is fully satisfied that they conform to the Contract Documents.

The Contract Price shall include the cost of furnishing all shop drawings, product data and samples, and the Contractor will be allowed no extra compensation for such drawings, product data or samples.

#### **1-06.1(2) Limitations of Engineer's Submittal Reviews**

Engineer's review and acceptance will be only to determine if the items covered by the submittals will, after installation or incorporation in the Work, conform to the information given in the Contract Documents and be compatible with the design concept of the completed Project as a functioning whole as indicated by the Contract Documents.

Engineer's review and acceptance will not extend to means, methods, techniques, sequences, or procedures of construction (except where a particular means, method, technique, sequence, or procedure of construction is specifically and expressly called for by the Contract Documents) or to safety precautions



or programs incident thereto. The review and acceptance of a separate item as such will not indicate acceptance of the assembly in which the item functions.

Engineer's review and acceptance of required Shop Drawings or Samples shall not relieve Contractor from responsibility for any variation from the requirements of the Contract Documents unless Contractor has complied with the requirements of Section 1-06.1(4) of the Special Provisions, and Engineer has given written acceptance of each such variation by specific written notation thereof incorporated in or accompanying the Shop Drawing or Sample. Engineer's review and acceptance shall not relieve Contractor from responsibility for complying with the requirements of Section 1-06.1(3) of the Special Provisions.

Engineer's check and review of Shop Drawings and Samples, Standard Specifications and descriptive literature submitted by Contractor will be only for general conformance with design concept, except as otherwise provided, and shall not be construed as:

1. Permitting any departure from the Contract Requirements;
2. Relieving the Contractor of the responsibility for any error in details, dimensions or other issues that may exist in such submittals;
3. Constituting a blanket acceptance of dimensions, quantities, or details of the material or equipment shown; or
4. Approving departures from additional details or instructions previously furnished by Engineer. Such check or review shall not relieve Contractor of the full responsibility of meeting all of the requirements of the Contract Documents.

### **1-06.1(3) Submittal Procedures and Requirements**

The Contractor shall transmit each submittal to the Engineer using a transmittal form provided by the Engineer. The Contractor shall certify that the contents of the submittal have been checked by the Contractor for conformance with the requirements of the Contract Documents. Submittals will not be reviewed without this certification. If it appears to the Engineer that the submittal has not been checked by the Contractor, no further review will occur and it will be deemed incomplete and returned to the Contractor with a determination of "Revise and Resubmit".

Before submitting each Shop Drawing or Sample, Contractor shall have determined and verified:

1. All field measurements, quantities, dimensions, specified performance and design criteria, installation requirements, materials, catalog numbers, and similar information with respect thereto;
2. The suitability of all materials with respect to intended use, fabrication, shipping, handling, storage, assembly, and installation pertaining to the performance of the Work;
3. All information relative to Contractor's responsibilities for means, methods, techniques, sequences, and procedures of construction, and safety precautions and programs incident thereto; and
4. Shall also have reviewed and coordinated each Shop Drawing or Sample with other Shop Drawings and Samples and with the requirements of the Work and the Contract Documents.

A separate form shall be used for a given specification section. That is, only an item or items that pertain to a given section shall be listed. Different items within a given section shall be listed.

All submittals shall be transmitted to the Engineer via the Contractor. Submittals direct from subcontractors or suppliers will not be accepted. Any communications which may occur between the Engineer and subcontractors and suppliers shall not be construed as binding on the Engineer, Contracting Agency or Contractor unless formalized in accordance with procedures set forth in the Contract Documents.

**Approved File Formats**

Submittals shall be Adobe PDF file format, version 8.0 or greater.

1. Bookmark all chapters, sections, and drawings.
  - a. Bookmarks shall include a logical description of the chapter or section or the title and number of the drawing.
2. Format shall be standard letter 8.5" x 11" for text and/or 11" x 17" landscape for drawings.
3. Acceptable fonts include:
  - a. Arial
  - b. Verdana
  - c. Helvetica,
  - d. Times New Roman
4. Font sizes for text based documents must be no less than 10 pt and no greater than 14 point for general text and no less than 12 pt and no greater than 18 pt for headers.
5. Font color must be black.
6. Text decoration, such as bold and italic, may only be used to emphasize key points.
7. Hyperlinks and graphics within the file is encouraged when appropriate.
8. Hyperlinks must use relative addressing.
9. Hyperlinks to information outside the primary domain of the client's intranet are unacceptable.
10. File names shall be in English, clearly convey the information contained in the file, and shall not exceed 100 characters in length. Only standard abbreviations may be used in file names.
11. Scanned documents are unacceptable.
12. Files shall not be password protected.

Each submittal shall be numbered consecutively, i.e. 1, 2, 3, etc. Assign re-submittals the same number as the original with a suffix of a sequential letter to denote it as a re-submittal. For example, the first re-submittal of submittal 25 would be 25A. Include only those items previously issued under the original submittal in re-submittals. Do not combine new submittals with re-submittals.

Where contents of submitted literature from manufacturers include data not pertinent to the submittal, the Contractor shall clearly indicate which item(s) or portion of the contents is provided and is to be reviewed by the Engineer.

The project data must be submitted in accordance with the instructions or the submittal may be returned without review, and the Contractor will not be entitled to any increase in Contract time. The Engineer will, upon completion of the review, return the transmittal form and a PDF copy of the submittal project data to the Contractor.

Engineer's review will be completed within ten (10) working days after receipt by Engineer of each complete submittal in proper sequence and will be returned to Contractor with one of the following markings:

1. "No Exceptions" indicates submittal has been reviewed and appears to be in conformance with requirements of the Contract Documents.
2. "Make Corrections Noted" indicates submittal appears to be in general conformance with requirements of the Contract Documents, but requires some corrections. Contractor shall incorporate the corrections noted. No re-submittal is required.

3. "Revise-Resubmit" indicates submittal does not appear to be in conformance with the Contract Documents. Engineer's comments will be noted on the submittal or in a separate letter. Contractor shall recheck, make necessary revisions, and resubmit.
4. "Reference" or "For Information Only" indicates submittal gives general information incidental to, but not required for, review or acceptance by the Engineer.
5. "Submittal Not Required-No Action Taken" indicates that the submittal is not called for by the Contract Documents and that no action was taken by Engineer on the submittal.

The Contractor shall submit to the Contracting Agency, to demonstrate compliance with applicable safety and environmental regulations, copies of any safety and accident prevention or pollution control and/or environmental monitoring plans applicable to the project and required of the Contractor by law, as well as any on-site safety program measures applicable to the Contracting Agency or its agents or members of the public visiting the work area. When such documents require approval by a government agency, the Contractor shall also furnish evidence of approval. These submittals are informational and any comment or lack of comment by the Contracting Agency or Engineer thereon shall not be construed as either acceptance or rejection of these documents, which shall be a matter for agencies having jurisdiction.

If the Contractor fails to make the proper changes to the submittal and the Engineer is required to review a submittal more than three (3) times, the Contracting Agency may deduct the costs for subsequent reviews from the Contract Price.

#### **1-06.1(4) Submittal Variations**

Variations from the Contract Document are not allowed without prior acceptance by the Engineer and shall be made at no additional cost to the Contracting Agency or extension of the contract time unless accepted by a change order. Contractor shall give Engineer specific written notice of any such variations that the Shop Drawing or Sample may have from the requirements of the Contract Documents. The variations shall be specifically identified on each Shop Drawing or Sample submitted to Engineer for review and acceptance and shall direct specific attention to each deviation from the Contract Documents and state any trades, dimension, functions or other aspects of the work that will be affected by the proposed change. Otherwise, the Contractor will not be relieved of the responsibility of executing the Work in accordance with the Contract Documents, even though such Shop Drawings or Samples have been otherwise reviewed.

The Contractor is responsible for the design of any construction changes resulting from any such deviation, for dimensions which shall be confirmed and coordinated at the job site, for fabrication processes and techniques of construction, for coordination of the work with that of all trades and for a complete installation which will function as intended and originally specified.

If a Shop Drawing or Sample, as submitted, indicates a variation from the Contract Requirements as set forth in the Contract Documents, Contractor shall identify the cost of the variation on the Shop Drawing or Sample. If the Engineer finds the variation to be in the interest of Contracting Agency and the variation involve no change in the Contract Price or time for performance, Engineer may approve the Shop Drawings or Samples.

#### **1-06.1(5) Re-submittals**

Contractor shall make corrections required by Engineer and shall return corrected copies in accordance with procedures described in Special Provision 1-06.1(3). Contractor shall direct specific attention in writing to revisions other than the corrections called for by Engineer on previous submittals.

#### **1-06.4 Handling and Storing Materials**

*Section 1-06.4 is supplemented with the following:  
(Local Agency SP)*

##### **1-06.4(1) Pipe**

Pipe and appurtenances shall be handled, stored, and installed as recommended by the manufacturer. Pipes with soft coatings such as coal tar enamel, paint, or the like shall be stored to protect the coating from physical damage or other deterioration and shall only be handled with padded, wide slings. Pipes

shipped with interior bracing shall have the bracing removed only when recommended by the pipe manufacturer.

#### **1-06.4(2) Equipment and Devices**

All equipment shall be adequately and effectively protected against damage from moisture, dust, handling, or other causes during transport from manufacturer's premises to the site. Each item or package shall be clearly marked with the number unique to the specification reference covering the item.

Stiffeners shall be used where necessary to maintain shapes and to give rigidity. Parts of equipment shall be delivered in assembled or sub-assembled units where possible.

All equipment items and valves with an assigned equipment number in this Project Manual shall have affixed to them in a prominent location, a label or tag displaying the assigned equipment number. Equipment item and valves lacking a number shall have a similar tag providing a unique description of the item. Markers shall be of stainless steel or aluminum, affixed to the item with stainless steel fasteners, or as otherwise approved by the Engineer. Plastic labels will not be acceptable.

During the interval between delivery and installation, all equipment shall be stored in enclosed, weather-tight licensed commercial warehouses. Environmental controls such as heaters or protective encapsulation shall be provided to ensure against condensation and moisture damage. In the event prolonged (more than 90 days) storage is required for any item of rotative equipment, the Contractor shall institute a preventive maintenance program that shall include grease protection of bare metal surfaces, periodic indexing of rotating parts, renewal of grease in bearings, and any procedures recommended by the manufacturer. The Contractor shall maintain adequate records to demonstrate full compliance with these requirements. All equipment shall be available for inspection by the Engineer.

After installation, all equipment shall be protected from damage, including but not limited to moisture, dust, abrasive particles, debris, and dirt generated by the placement, chipping, sandblasting, cutting, finishing, and grinding of new or existing concrete, terrazzo, and metal; and the fumes, particulate matter, and splatter from welding, brazing, and painting of new and existing piping and equipment. The Contractor is advised that as a minimum, vacuum cleaning, blowers with filters, protective shielding, and other dust-suppression methods will be required at all times to adequately protect all equipment. During concreting, including finishing, all equipment that may be affected by cement dust must be completely covered. During painting operations, all grease fittings and similar openings shall be covered to prevent the entry of paint. Electrical switch gear, unit substation, and motor load centers shall not be installed until all concrete work and sandblasting in those areas have been completed and accepted.

#### **1-06.4(3) Delivery of Material or Equipment**

The Contracting Agency's or Engineer's personnel or representatives of the Contracting Agency or Engineer will not accept materials or equipment deliveries for the Contractor.

#### **1-06.6 Substitutions**

*Section 1-06.6 is added as the following:  
(Local Agency SP)*

Whenever an item of material or equipment is specified or described in the Contract Documents by using the name of a proprietary item or the name of a particular Supplier, the specification or description is intended to establish the type, function, appearance, and quality required. Unless the specification or description contains or is followed by words reading that no like, equivalent, or "or equal" item or no substitution is permitted, other items of material or equipment or material or equipment of other Suppliers may be submitted to Engineer for review.

#### **"Or Equal Items"**

"Or Equal" Items: If, in Engineer's sole discretion, an item of material or equipment proposed by Contractor is functionally equal to that named and sufficiently similar so that no change in related Work will be required, it may be considered by Engineer as an "or equal" item, in which case review and acceptance of the proposed item may, in Engineer's sole discretion, be accomplished without compliance with some or all of the requirements for acceptance of proposed substitute items. For the purposes of

this paragraph, a proposed item of material or equipment will be considered functionally equal to an item so named if; in the exercise of reasonable judgment Engineer determines:

1. The proposed item is at least equal in materials of construction, quality, durability, appearance, strength, and design characteristics;
2. The proposed item will reliably perform at least equally well the function and achieve the results imposed by the design concept of the completed Project as a functioning whole;
3. Operation and maintenance costs and requirements are reasonably similar; and
4. The proposed item has a proven record of performance and comparable availability of service and parts.

Contractor shall also certify that, if approved and incorporated into the Work:

1. No increase in cost to the Contracting Agency or increase in Contract Times will result, and
2. The proposed item will conform to the detailed requirements of the item named in the Contract Documents.

If requested by the Engineer, Contractor shall furnish additional information for the Engineer's review and consideration. Insufficient or inadequate information to substantiate an "or equal" determination by the Engineer will be grounds for rejection.

#### **Substitute Items**

If, in Engineer's sole discretion, an item of material or equipment proposed by Contractor does not qualify as an "or-equal" item, it will be considered a proposed substitute item. Contractor shall submit sufficient information as provided below to allow Engineer to determine that the item of material or equipment proposed is essentially equivalent to that named and an acceptable substitute therefore. Requests for review of proposed substitute items of material or equipment will not be accepted by Engineer from anyone other than Contractor.

The requirements for review by Engineer will be as set forth herein and as Engineer may decide is appropriate under the circumstances. Contractor shall make written application to Engineer for review of a proposed substitute item of material or equipment that Contractor seeks to furnish or use. The application:

1. Shall certify that the proposed substitute item will:
  - a. Perform adequately the functions and achieve the results called for by the general design,
  - b. Be similar in substance to that specified, and
  - c. Be suited to the same use as that specified;
2. Will state:
  - a. The extent, if any, to which the use of the proposed substitute item will prejudice Contractor's achievement of Substantial Completion on time;
  - b. Whether or not use of the proposed substitute item in the Work will require a change in any of the Contract Documents (or in the provisions of any other direct contract with Contracting Agency for other work on the Project) to adapt the design to the proposed substitute item; and
  - c. Whether or not incorporation or use of the proposed substitute item in connection with the Work is subject to payment of any license fee or royalty;
3. Will identify:
  - a. All variations of the proposed substitute item from that specified;

- b. Available engineering, sales, maintenance, repair, and replacement services; and
  - c. Schedule impacts and changes to the construction schedule
4. Shall contain an itemized estimate of all costs or credits that will result directly or indirectly from use of such substitute item, including costs of redesign and claims of other contractors affected by any resulting change,

Contractor shall supply three (3) copies of data substantiating compliance of proposed product or supplier with Contract Documents on all requests for acceptance of change of any product or manufacturer. Each copy shall include:

- 1. Detailed description of the proposed change, including:
  - a. Product identification, including manufacturer's name and address;
  - b. Manufacturer's identification, including manufacturer's name and address;
  - c. Samples of proposed products;
  - d. Name, address, and telephone number of contact persons for similar projects on which product was used and date of installation; and
  - e. Drawings indicating and vertical details of all architectural, structural, mechanical and electrical elements of proposed change.
- 2. Itemized comparison of proposed substitution with product or supplier specified;
- 3. Relation to separate subcontracts and trades;
- 4. Cost data on proposed substitution in comparison with product or supplier specified; and
- 5. Operation and maintenance requirements and costs;

Requests for change of product or design shall include certification by the Contractor that:

- 1. The Contractor has personally investigated the proposed product or design deviation and has determined that it is equal or superior in all respects to that specified;
- 2. The Contractor will provide the same guarantee for product or design deviation as for product or design specified; and
- 3. The Contractor will coordinate installation of accepted product or design deviation into work, making such changes as may be required for work to be complete in all respects.

Requests for change of products will not be considered if:

- 1. They are indicated or implied on project data submittals without a formal request having been submitted; and/or
- 2. Acceptance will require substantial revision to the Contract Documents.

#### **Substitute Construction Methods or Procedures**

If a specific means, method, technique, sequence, or procedure of construction is expressly required by the Contract Documents, Contractor may furnish or utilize a substitute means, method, technique, sequence, or procedure of construction approved by Engineer. Contractor shall submit sufficient information to allow Engineer, in Engineer's sole discretion, to determine that the substitute proposed is equivalent to that expressly called for by the Contract Documents. The requirements for review by Engineer will be similar to those required for substitute items.

#### **Engineer's Evaluation**

Engineer will be allowed a reasonable time within which to evaluate each proposal or submittal made. Engineer may require Contractor to furnish additional data about the proposed substitute item, method or procedure. Engineer will be the sole judge of acceptability. No "or equal" or substitute will be ordered,

installed or utilized until Engineer's review is complete, which will be evidenced by either a Change Order or an approved Shop Drawing. Engineer will advise Contractor in writing of any negative determination. The Engineer may elect to reject any or all requests for deviation at his sole discretion without cause or justification. The Contractor shall immediately proceed with the Work in accordance with the Contract Documents upon notification of rejection of any request for deviation.

**Special Guarantee**

Contracting Agency may require Contractor to furnish, at Contractor's expense, a special performance guarantee or other surety with respect to any substitute, change in construction methods or procedures, or change in design.

**Engineer's Cost Reimbursement**

Engineer will record Engineer's costs in evaluating a substitute proposed or submitted by Contractor. Whether or not Engineer approves a substitute item so proposed or submitted by Contractor, the Contracting Agency may subtract said costs from payments due to the Contractor. The Contracting Agency may also subtract any charges of the Engineer associated with making changes in the Contract Documents (or in the provisions of any other direct contract with Contracting Agency) resulting from the acceptance of each proposed substitute.

**Contractor's Expense**

Contractor shall provide all data in support of any proposed substitute or "or equal" at Contractor's expense. The Contractor shall be responsible for and assume all costs of all elements involving implementing and completing approved deviations including, but not limited to, coordination, confirming dimensions at the job site, design, preparation of plans, procurement of materials and equipment, fabrication, construction, installation and instigation of service. If, in the opinion of the Engineer, the completed improvements of each deviation do not fulfill, provide and meet the defined and implied intent of the Contract Documents, the Contractor shall provide the labor, materials, and equipment required to modify the Work to the satisfaction of the Engineer.

The Contractor shall be responsible for modifications to electrical, structural, mechanical, or other aspects of the work or design as required to install or incorporate materials or equipment selected by the Contractor.

Regardless of the method of specification or selection, any product which is installed or incorporated into the work without prior acceptance of the Engineer may not be accepted by the Contracting Agency.

When material or equipment is specified by performance requirement or reference to specifications, standards, or publications of organizations, the Contractor shall select material or equipment which the Contractor considers to comply with the specified reference standard. The Contractor shall submit a request for acceptance of the selected product in accordance with these Special Provisions.

**1-06.7 Testing and Quality Control**

*Section 1-06.7 is added as the following:  
(Local Agency SP)*

**Contracting Agency-Furnished Testing and Inspections**

The Contracting Agency will retain a qualified independent testing laboratory to perform the laboratory and field tests listed below:

1. Testing of backfill materials (e.g., sieve analysis, sand equivalent)
2. Moisture-density relationships of backfill materials
3. In-place soil density of trench backfill
4. In-place soil density of structure backfill
5. In-place soil density of paving sub-base and structural section, including asphalt concrete
6. Concrete slump and compressive strength on field placed cement concrete

**7. Special inspections**

The Contractor shall fully cooperate with Contracting Agency-Furnished Testing and Inspections. Contractor shall provide Contracting Agency's Representative timely notice on the readiness of work for required inspections, tests or acceptance. The Contractor shall provide access to the work for testing personnel. Where testing is to be performed in a potentially unsafe or confined work area, the Contractor shall stop work and provide all required safety measures to assure the safety of testing personnel.

The Contracting Agency will provide one copy of test results to the Contractor as soon as they are available. The Contractor shall anticipate that extensive laboratory and/or field testing will be performed by the laboratory retained by the Contracting Agency.

The Contractor shall anticipate that such testing may hinder, delay, or complicate execution of the work. The Contractor shall not be entitled to an extension of Contract Time or to any claim for damages because of hindrances, delays, or complications caused by or resulting from laboratory and/or field testing performed by the Contracting Agency.

Special inspection by certified inspectors and a certified testing lab may be required on the following, but not limited to:

1. Structural steel
2. Structure concrete reinforcement and concrete
3. Masonry
4. Structure excavation/fill
5. Anchor bolts

The Contractor shall coordinate with the Contracting Agency's Representative and fully cooperate with the testing services company for the above testing and special inspections and other testing and special inspections as may be specified elsewhere in the Special Provisions. The Contractor shall provide access to the work for testing personnel. Where testing is to be performed in a potentially unsafe or confined work area, the Contractor shall stop work and provide all required safety measures to assure the safety of testing personnel. Contractor shall furnish Engineer copies of all agency inspection reports or approvals.

**Correction of Defective Work**

If test or operational results indicate that the work performed, or materials or equipment furnished, by the Contractor does not comply with the Contract Documents, the Contractor shall immediately take all necessary measures to correct the defective work, and/or replace defective materials or equipment. Depending on the situation, an independent testing firm may be retained to test the corrected work to determine if the corrections are satisfactory. All costs that are incurred by the Contracting Agency and Engineer as a result of the defective work, materials or equipment, including retesting, shall be borne by the Contractor and will be deducted from progress payments.

**END OF SECTION 1-06**



**1-07 Legal Relations and Responsibilities to the Public****1-07.1 Laws to be Observed**

*Section 1-07.1 is supplemented with the following:  
(October 1, 2005 APWA GSP)*

In cases of conflict between different safety regulations, the more stringent regulation shall apply.

The Washington State Department of Labor and Industries shall be the sole and paramount administrative agency responsible for the administration of the provisions of the Washington DOSH.

The Contractor shall maintain at the project site office, or other well-known place at the project site, all articles necessary for providing first aid to the injured. The Contractor shall establish, publish, and make known to all employees, procedures for ensuring immediate removal to a hospital, or doctor's care, persons, including employees, who may have been injured on the project site. Employees should not be permitted to work on the project site before the Contractor has established and made known procedures for removal of injured persons to a hospital or a doctor's care.

The Contractor shall have sole responsibility for the safety, efficiency, and adequacy of the Contractor's plant, appliances, and methods, and for any damage or injury resulting from their failure, or improper maintenance, use, or operation. The Contractor shall be solely and completely responsible for the conditions of the project site, including safety for all persons and property in the performance of the work. This requirement shall apply continuously, and not be limited to normal working hours. The required or implied duty of the Engineer to conduct construction review of the Contractor's performance does not, and shall not, be intended to include review and adequacy of the Contractor's safety measures in, on, or near the project site.

*Section 1-07.1 is further supplemented with the following:  
(Local Agency SP)*

The Contractor shall be responsible to immediately report to the Engineer any deviation from the contract provisions pertaining to environmental compliance, including but not limited to spills, unauthorized fill in waters of the State, including wetlands, water quality standards, noise, air quality, etc.

**1-07.2 State Taxes**

*Section 1-07.2 is deleted, including its sub-sections, and replaced with the following:  
(June 27, 2011 APWA GSP):*

**1-07.2 State Sales Tax**

The Washington State Department of Revenue has issued special rules on the State sales tax. Sections 1-07.2(1) through 1-07.2(4) are meant to clarify those rules. The Contractor should contact the Washington State Department of Revenue for answers to questions in this area. The Contracting Agency will not adjust its payment if the Contractor bases a bid on a misunderstood tax liability.

The Contractor shall include all Contractor-paid taxes in the unit bid prices or other contract amounts. In some cases, however, state retail sales tax will not be included. Section 1-07.2(2) describes this exception.

The Contracting Agency will pay the retained percentage (or release the Contract Bond if a FHWA-funded Project) only if the Contractor has obtained from the Washington State Department of Revenue a certificate showing that all contract-related taxes have been paid (RCW 60.28.051). The Contracting Agency may deduct from its payments to the Contractor any amount the Contractor may owe the Washington State Department of Revenue, whether the amount owed relates to this contract or not. Any amount so deducted will be paid into the proper State fund.

**1-07.2(1) State Sales Tax – Rule 171**

WAC 458-20-171, and its related rules, apply to building, repairing, or improving streets, roads, etc., which are owned by a municipal corporation, or political subdivision of the state, or by the United States, and which are used primarily for foot or vehicular traffic. This includes storm or combined sewer systems

within and included as a part of the street or road drainage system and power lines when such are part of the roadway lighting system. For work performed in such cases, the Contractor shall include Washington State Retail Sales Taxes in the various unit bid item prices, or other contract amounts, including those that the Contractor pays on the purchase of the materials, equipment, or supplies used or consumed in doing the work.

**1-07.2(2) State Sales Tax – Rule 170**

WAC 458-20-170 and its related rules apply to the constructing and repairing of new or existing buildings, or other structures, upon real property. This includes, but is not limited to, the construction of streets, roads, highways, etc., owned by the state of Washington; water mains and their appurtenances; sanitary sewers and sewage disposal systems unless such sewers and disposal systems are within, and a part of, a street or road drainage system; telephone, telegraph, electrical power distribution lines, or other conduits or lines in or above streets or roads, unless such power lines become a part of a street or road lighting system; and installing or attaching of any article of tangible personal property in or to real property, whether or not such personal property becomes a part of the realty by virtue of installation.

For work performed in such cases, the Contractor shall collect from the Contracting Agency, retail sales tax on the full contract price. The Contracting Agency will automatically add this sales tax to each payment to the Contractor. For this reason, the Contractor shall not include the retail sales tax in the unit bid item prices, or in any other contract amount subject to Rule 170, with the following exception.

Exception: The Contracting Agency will not add in sales tax for a payment the Contractor or a subcontractor makes on the purchase or rental of tools, machinery, equipment, or consumable supplies not integrated into the project. Such sales taxes shall be included in the unit bid item prices or in any other contract amount.

**1-07.2(3) Services**

The Contractor shall not collect retail sales tax from the Contracting Agency on any contract wholly for professional or other services (as defined in Washington State Department of Revenue Rules 138 and 244).

**1-07.5(3) State Department of Ecology**

*Section 1-07.5(3) is supplemented with the following:  
(Local Agency SP)*

The Contractor shall provide for safe access to the construction site and to the Contractor's records by the Washington State Department of Ecology personnel.

**1-07.5(5) Noise Restrictions**

*Section 1-07.5(5) is added as the following:  
(Local Agency SP)*

The Contractor shall comply with all local controls and noise level rules, specified requirements, regulations and ordinances which apply to any work performed pursuant to the Contract. If the requirements of this Section are more restrictive than those of the local regulations or specified in Section 02 22 29, the requirements of this Section shall govern.\*

Each internal combustion engine, used for any purpose on the job or related to the job, shall be enclosed and be equipped with a muffler of a type recommended by the manufacturer. No internal combustion engine shall be operated on the project without said muffler and enclosure.

Noise levels for scrapers, pavers, graders and trucks shall not exceed 90 dBA and pile drivers shall not exceed 95 dBA at 50 feet as measured under the noisiest operating conditions. For all other equipment, noise levels shall not exceed 85 dBA. Equipment that cannot meet these levels shall be quieted by the use of improved exhaust mufflers, portable acoustical screens, or other means. Equipment not modified to meet these requirements shall be removed from the project.

Where feasible, the Contractor shall use electric rather than diesel or gas-powered equipment.

**1-07.6 Permits and Licenses**

*Section 1-07.6 is deleted and replaced with the following:  
(Local Agency SP)*

**1-07.6(1) Contracting Agency-Furnished Permits**

The Contracting Agency is responsible for obtaining the following permits:

1. SEPA Exemption.
2. NEPA Determination (Categorical Exclusion)
3. Section 106 National Historic Preservation Act Concurrence.
4. Hydraulic Project Approval
5. Shoreline Exemption

Copies of these Contracting Agency-Furnished permits are included in Appendix B.

The Contractor shall comply with all conditions and requirements of the Contracting Agency-Furnished Permits. The Contractor shall provide access to the project by regulatory officials for determination of compliance. The Contractor shall anticipate that compliance with the permits and any necessary corrective action may result in delay or hindrance of the Contractor's prosecution of the work. The Contractor shall not be entitled to any additional compensation or extension of Contract Time for delays or additional work resulting from compliance with Contracting Agency-Furnished Permits.

**1-07.6(2) Contractor-Furnished Permits**

The Contractor shall apply for, and pay all costs associated with all other required permits not listed as Contracting Agency-Furnished Permits in Section 1-07.6(1) above. Failure of the Contractor to identify and obtain all required permits shall not relieve the Contractor of the responsibility of compliance with all applicable regulatory requirements.

The Contractor shall comply with all conditions and requirements of the Contractor-Furnished Permits. The Contractor shall provide safe access to the project by regulatory officials for determination of compliance. The Contractor shall anticipate that compliance with the permits and any necessary corrective action may result in delay or hindrance of the Contractor's prosecution of the work. The Contractor shall not be entitled to any additional compensation or extension of Contract Time for delays or additional work resulting from compliance with Contractor-Furnished Permits.

The Contractor shall furnish all bonds and insurance required by the controlling agencies, and shall, if requested, pay for any inspection and testing.

The Contractor shall furnish the Engineer with one copy of each permit issued for borrow, fill, or waste material required for or generated by the contract work. The Contractor shall notify the Engineer in writing of the location of all borrow, fill, and waste sites regardless of whether a permit is required.

All costs incurred by the Contractor in procuring permits and complying with stipulations in the permits and approvals shall be incidental to and included in the various items of work in the project; and no additional compensation will be made.

Anticipated Contractor-Furnished Permits include:

1. State of Washington Department of Ecology Construction Stormwater General Permit
2. Kitsap County Encroachment/ROW/Roadway Permit.
3. WSDOT ROW Permit.

Contractor may modify the SWPPP to address the Contractor's means and methods or prepare a new SWPPP as required by the Construction Stormwater General Permit.

**1-07.6(3) Business and Contracting Licenses**

At a minimum, the Contractor and his subcontractors shall have the following licenses and shall submit proof of such licensing to the Contracting Agency upon request:

1. Washington State Contractor License

**1-07.9(1) General**

*Section 1-07.9(1) is supplemented with the following:  
(Local Agency SP)*

Workers shall be paid at least the wages printed in the current prevailing wage rates at the time of the bid opening as prepared by the Department of Labor and Industry. A copy of the journey level rates for Kitsap County rates is included in Appendix A and is made a part of the Contract. The Contractor is referred to the Department of Labor and Industries website stated below for information regarding apprentice level rates. Contractor shall be responsible for checking and obtaining any updates or corrections to these wage rates and complying with any modifications prior to bidding. Contractor shall account for increased labor costs in his bid and no additional payment shall be made for increases in the prevailing wage rates for the project's duration. Prevailing wage rates can be obtained from the Industrial Statistician upon request at the following address:

Department of Labor and Industries  
Prevailing Wage Office  
P.O. Box 44540  
Olympia, WA 98504-4540  
Telephone: (360) 902-5335  
Fax: (360) 902-5300  
<http://www.lni.wa.gov/TradesLicensing/PrevWage/WageRates>

Contractors may also contact the Kitsap County Purchasing Office at the contact information contained in the Invitation to Bid to view or obtain a hard copy of the applicable wage rates.

Before payment is made by or on behalf of the Contracting Agency of any sums due under this Contract, the Contractor and each subcontractor shall submit a Statement of Intent to Pay Prevailing Wages and an Affidavit of Wages Paid. It shall be the responsibility of the Contractor to require all subcontractors to complete Affidavits of Wages Paid and to make the proper filing of same.

A fee per each Statement of Intent to Pay Prevailing Wages and Affidavit of Wages Paid is required to accompany each form submitted to the Department of Labor and Industries. The Contractor is responsible for payment of these fees and shall make all applications directly to the Department of Labor and Industries with a copy of all said applications being provided to the Contracting Agency. These fees shall be incidental to and included in the Contract Price.

**1-07.13(1) General**

*Section 1-07.13(1) is supplemented with the following:  
(Local Agency SP)*

The Contracting Agency reserves the right to use and/or occupy any portion of the project or its improvements which have been completed sufficiently to permit use and occupancy and such use shall not be construed as an acceptance of the work or any part thereof, and any claims which the Contracting Agency may have against the Contractor shall not be deemed to have been waived by such use and/or occupancy.

**1-07.14 Responsibility for Damage**

*Section 1-07.14 is supplemented with the following:  
(Local Agency SP)*

The Contractor shall protect, defend, indemnify, and save harmless the Contracting Agency, its officers, officials, employees, agents, and Engineer from any and all claims, demands, suits, penalties, losses, damages, judgments, or costs of any kind whatsoever (hereinafter "claims"), arising out of or in any way resulting from the Contractor's officers, employees, agents, and/or subcontractors of all tiers, acts or omissions, performance or failure to perform this Contract, to the maximum extent permitted by law or as defined by RCW 4.24.115, now enacted or as hereinafter amended.

The Contractor's obligations under this section shall include, but not be limited to:

1. The duty to promptly accept tender of defense and provide defense to the Contracting Agency at the Contractor's own expense.
2. The duty to indemnify and defend the Contracting Agency and Engineer from any claim, demand, and/or cause of action brought by or on behalf of any of its employees, or agents. The foregoing duty is specifically and expressly intended to constitute a waiver of the Contractor's immunity under Washington's Industrial Insurance Act, RCW Title 51, as respects the Contracting Agency with a full and complete indemnity and defense of claims made by the Contractor's employees. The parties acknowledge that these provisions were mutually negotiated and agreed upon by them.
3. To the maximum extent permitted by law, the Contractor shall indemnify and defend the Contracting Agency and Engineer from and be liable for all damages and injury which shall be caused to owners of property on or in the vicinity of the work or which shall occur to any person or persons or property whatsoever arising out of the performance of this Contract, whether or not such injury or damage is caused by negligence of the Contractor or caused by the inherent nature of the work specified.

The Contracting Agency may, in its sole discretion, withhold amounts sufficient to pay the amount of any claim for injury, and/or pay any claim for injury of which the Contracting Agency may have knowledge, regardless of the formalities of notice of such claim, arising out of the performance of this Contract.

An amount withheld will be held until the Contractor secures a written release from the claimant, obtains a court decision that such claim is without merit, or satisfies any judgment on such claim. In addition, the Contractor shall reimburse and otherwise be liable for claims costs incurred by the Contracting Agency, including, without limitation, costs for claims adjusting services, attorneys, engineering, and administration.

In the event the Contracting Agency incurs any judgment, award, and/or costs arising, including attorneys' fees, from enforcing the provisions of this provision, all such fees, expenses, and costs shall be recoverable from the Contractor.

**1-07.15 Temporary Water Pollution/Erosion Control**

*Section 1-07.15 is supplemented with the following:  
(Local Agency SP)*

The Contractor shall submit bi-weekly updates of the temporary water pollution/erosion control plan. These updates shall include, but are not limited to, sketches showing location of control facilities such as straw bales, silt fences, and areas to be covered at end of shift. These updates shall be submitted to the Engineer for review every other week unless otherwise directed by the Engineer. The Engineer will review the updated plan and provide comments to Contractor.

The Contractor shall be responsible throughout the life of the project to take all necessary precautions to prevent pollution, erosion, siltation, and related damage to property caused by any water leaving work areas, including borrow and stockpile areas. All silt shall be contained within the construction area. Required temporary water pollution control measures shall be in accordance with the requirements of Section 31 25 14.

The Contractor shall pay all fines and citations charged to the Contracting Agency for discharging turbid water from the site during the life of the project. In addition, the Contractor shall pay all costs for repair to property damaged (onsite and offsite) by water discharged from work areas used in this Contract.

Construction and maintenance of erosion control measures shall be performed according to the Contract Documents and applicable permits. Other or additional temporary water pollution/erosion control measures may be required at the discretion of the Engineer. Costs for temporary water pollution/erosion control shall be in accordance with that specified in Section 8-01 as amended in the Special Provisions.

The Contractor shall meet all federal, state and local pollution control regulations for all work performed under this contract. No lime, wet concrete, petroleum products, silts, organic material or other deleterious materials are allowed to fall, flow, leach, or otherwise enter public waters.

The Contractor shall observe all statutes, ordinances and regulations pertaining to the prevention of environmental pollution and the preservation of public natural resources. All such statutes, ordinances, regulations or portions thereof pertaining to work under this contract are hereby incorporated with and made part of this contract.

The Contractor shall be aware of these provisions and coordinate with the specific controlling agencies.

The Contractor shall furnish all bonds and insurance required by the controlling agencies and shall, if requested, pay for any inspections and testing accomplished or furnished by them.

#### **1-07.15(1) Spill Prevention, Control and Countermeasures Plan**

*Section 1-07.15(1) is supplemented and modified as follows:  
(Local Agency SP)*

All costs associated with this work shall be considered incidental to the construction and included in other items of work.

#### **1-07.16(1) Private/Public Property**

*Section 1-07.16(1) is supplemented with the following:  
(Local Agency SP)*

The Contractor shall restore all roads and streets in which the surface is removed, broken or damaged, or in which the ground has caved or settled, due to hauling of materials, equipment and/or supplies and installation of the improvements covered by this contract, to the original grade and crown section unless otherwise indicated. Contractor shall match the existing surfacing for depth, materials and surface finish, including striping and pavement markings, except as otherwise specified.

At all times during work, the Contractor shall keep the premises clean and orderly, and upon completion of the work, repair all damage caused by equipment and leave the project free from all rubbish and excess material of any kind.

The Contractor shall reconstruct all curbs, driveways, sidewalks and similar structures and utilities, which are broken or damaged during construction. Reconstruct with the same kind of material with the same finish, and in not less than the same dimensions as the original work. Remove and replace the entire portions between joints or scores and not merely by refinishing the damaged part. Match the appearance of the existing improvements as nearly as possible.

The Contractor shall be fully responsible for the prevention of damage to the City's, County's or State's roads. Prior to beginning construction, the Contractor shall obtain any and all licenses or permits required for the travel on, and work within, the Road Right-of-Way.

Paved areas including adjacent or haul route streets shall be maintained for the duration of the Contract. Street sweeping shall be performed as required and at the direction of the Engineer using a self-propelled vehicle outfitted with rotating brushes and a filtered vacuum system to collect sediment, dust, and debris from paved road surfaces. The vehicle shall store street sweepings internally. Collected street sweepings shall be disposed of by approved disposal method(s) in accordance with the Contract. The Contractor shall provide a wheel wash, if necessary, to prevent tracking of mud and dirt onto paved roads. Wheel wash water shall not be discharged to any storm drain or stream. Thoroughly clean all

spilled dirt, gravel, or other material caused by the construction activities from all roads and streets at the end of each day.

The Contractor shall at all times maintain the integrity of the existing pavement, shoulder, culverts, and roadside ditches. If the existing pavement or shoulder is removed, broken, or damaged as a result of the construction of the improvements covered by this Contract, the Contractor shall restore the damaged area to the original grade and crown sections in accordance with the Standard Specifications. New surfacing shall match the existing surfacing for depth, materials and surface finish, including striping and pavement markings. Restore all culverts equal to existing condition or better.

Vehicles leaving the site shall be cleaned and loads secured to prevent the deposition of muds, silts, sands and construction materials on roads or highways. Any such degradation of roads or highways shall be corrected by the end of each working day so that the road is in a clean state. Tracked vehicles shall be constrained to paved or unpaved areas that will be restored.

#### **1-07.16(2) Vegetation Protection and Restoration**

*Section 1-07.16(2) is supplemented with the following:  
(Local Agency SP)*

Restore all areas that are disturbed or damaged by actions of the Contractor to their original condition. Remove ornamental trees and shrubbery with earth surrounding the roots wrapped in burlap, and replant in their original positions, or, as an alternative, replace with equal material.

For lawn areas, cut sod, roll and replace after the excavation has been properly compacted or, as an alternative, cover the excavated area with top soil to the depth of the original top soil and reseed, water and maintain as directed.

The materials storage areas shall be re-graded and seeded at the conclusion of the project. Any damage to fences, walks, curbs, driveways, etc. shall be handled in accordance with the applicable sections of these specifications.

The Contractor shall obtain a signed release from all property owners whose property is impacted by the construction stating that the restoration has been done to the property owner's satisfaction. If the Contractor cannot obtain such a release, and the restoration has been done to what should be acceptable, the Contractor shall notify the Engineer and explain why a signed release cannot be obtained. Engineer shall then judge whether Contractor may be released from this requirement for that property.

#### **1-07.16(4) Archaeological and Historical Objects**

*Section 1-07.16(4) is supplemented with the following:  
(Local Agency SP)*

The Contractor shall perform work and coordinate with the County to comply with the requirements stated in the Inadvertent Discovery Plan included within the Construction Quality Assurance Plan included as Appendix B.

#### **1-07.16(4)A Inadvertent Discovery of Human Skeletal Remains**

*The first paragraph of Section 1-07.16(4)A is revised to read as follows:  
(Local Agency SP)*

If human skeletal remains are encountered by the Contractor, they shall not be further disturbed. The Contractor shall immediately notify the Engineer of any such finds, and shall cease all work in the area of, and adjacent to, the discovery, in an area adequate to provide for the total security and protection of the integrity of the skeletal remains. The Contractor shall comply with the Plan and Procedures for the Unanticipated Discovery of Cultural Resources and Human Skeletal Remains included in Appendix B. In accordance with RCW 27.44.055 (Duty to Notify section of Indian Graves and Records Act), the Engineer will notify the Contracting Agency who will then be responsible for making the necessary notifications and ensuring that the appropriate actions are taken to secure and protect the discovery site and remains. The Engineer or Contracting Agency may require the Contractor to suspend work in the vicinity of the discovery until final determinations are made and removal of the skeletal remains is completed.

**1-07.16(6) Interfering Structures**

*Section 1-07.16(6) is added as the following:  
(Local Agency SP)*

The Contractor shall take necessary precautions to prevent damage to existing structures whether on the surface, aboveground, or underground. An attempt has been made to show major structures on the Drawings. The completeness and accuracy of information shown however, cannot be guaranteed. Protect underground and aboveground existing structures from damage, whether or not they lie within the limits of the easements obtained by the Contracting Agency. Where such existing fences, gates, barns, sheds, buildings, or any other structure must be removed in order to properly carry out the construction, or are damaged during construction, restore to their original condition to the satisfaction of the property owner involved at the Contractor's own expense. Notify the Engineer of any damaged underground structure, and make repairs or replacements before backfilling.

If existing structures are encountered which prevent the construction, and which are not properly shown on the Drawings, notify the Engineer before continuing with the construction in order that the Engineer may make such field revisions as necessary to avoid conflict with the existing structures. It is expected that minor relocations of the work will be necessary during the progress of construction. If the Contractor fails to notify the Engineer when an existing structure is encountered, and proceeds with construction despite this interference, the Contractor shall do so at the Contractor's own risk and expense.

**1-07.17 Utilities and Similar Facilities**

*Section 1-07.17 is supplemented with the following:  
(Local Agency SP)*

The information shown or indicated in the Contract Documents with respect to existing underground facilities at or contiguous to the site is based on available information furnished to the Contracting Agency or Engineer by the owners of such Underground Facilities without necessarily uncovering, measuring or other verification of the utilities. The depth of existing utilities, if indicated, may only be an approximation. Additional utilities may be encountered and the actual locations of the utilities indicated on the Plans may vary from the locations indicated. The information is provided for the convenience of the Contractor only, and no responsibility is assumed by either the Contracting Agency or the Engineer for its accuracy or completeness. The Contractor shall have full responsibility for reviewing and checking utility information, locating all underground facilities, and coordinating work with the owners of such underground facilities. The Contractor shall take the necessary precautionary measures to protect the existing utilities and structures indicated and any other utilities or structures which may be encountered during construction and shall be responsible for the repair of any damage thereto resulting from the work if:

1. The utility owner has field located and marked its facilities and the actual location of any portion of the utility is within two feet horizontally either side of said location mark; or
2. The utility system is visible or has become visible or can be reasonably assumed to exist at the location due to visible evidence prior to the damage; or
3. The Contractor failed to provide the required notification to the utility owner prior to the damage to the utility; or
4. The actual depth is different by more than one (1) foot from than that indicated on the Plans.

Existing underground utilities, whether public or private, which are damaged by the Contractor, will be repaired by the utility owner or as directed by the utility owner.

All existing utilities shall be maintained in continuous operation and properly protected during the Contractor's operations, unless the Contractor receives written approval from the utility owner for interruption of service. In addition, all work by the Contractor adjacent to, or in the vicinity of, existing utilities shall be performed in accordance with the requirements of the utility owners. The Contractor shall pay all permit, inspection, and other fees levied by the utility owners. Where the Contractor's operations could damage or inconvenience other utility systems or services, the operations shall be suspended until all arrangements necessary for the protection or relocation of these utilities and services have been made



by the Contractor. Notify all utility offices, which are affected by the construction operation at least 48 hours in advance. Under no circumstances expose any utility without first obtaining permission from the appropriate agency. Once permission has been granted, locate, expose, and provide temporary support for all existing underground utilities.

The Contractor shall anticipate that service lines between utility systems and private residences will be encountered and no additional compensation shall be made with work associated with crossings of any service lines. Service lines may not be shown on the Plans and may not be field located by the utility. The Contractor shall determine the actual location and protect from damage all service lines. If any utilities or service lines are damaged by the construction operations, Contractor shall promptly notify the proper authority and begin or cause the repair as required by the utility so that the utility or service is back in service as promptly as possible. In no case shall interruption of any water, sewer, or other utility service be allowed to exist outside working hours unless prior approval is granted.

In the event the Contractor encounters water service lines that interfere with trenching, the Contractor may, by obtaining prior approval of the property owner, Water Department and the Engineer, cut the service, dig through, and restore the service with similar and equal materials at the Contractor's sole expense. In the event the Contractor encounters water service lines that interfere with new improvements, the Contractor shall notify the Engineer.

Some existing utility poles, lines, piping and/or appurtenances may need to be held in place, removed or relocated as part of this project. If said work is required, the Contractor shall coordinate and schedule all such work with the respective utilities so that the Contractor's work and schedule are not impacted. Public and private utilities, or their contractors, will furnish all work necessary to hold, adjust, relocate, replace, or construct their facilities unless otherwise provided for in the Plans or these Special Provisions. Such work, if required, will be done during the prosecution of the work for this project. The Contractor's attention is directed to the fact that significant lead times may potentially be required to coordinate and schedule with the utility companies to perform the work.

Removal, relocation, and adjustment of existing utilities where shown on the Plans or where it could reasonably be foreseen to accommodate the work by the Contractor shall be ordered and paid for by the Contractor. If or when utility conflicts occur, the Contractor shall continue construction on other aspects of the project. Any change to the operation necessary to work around the conflicts shall be incidental to the various bid items of the contract and no further compensation will be made.

The Contractor shall anticipate that the owners of existing utilities may choose to modify and/or improve the existing systems at the time that the Contractor is working. The Contractor shall perform any and all work required to accommodate concurrent work by the owners of existing utilities. The Contractor shall coordinate his activities with those of the utility owners to enable both activities to proceed without delay.

The Contractor shall call the Utilities Underground Locate Center (One Call Center) for field location of utilities not less than two or more than ten business days before the scheduled date for commencement of excavation which may affect underground utility facilities. Notice shall be provided individually to those owners who are not members of the one-number locator service and are known to or suspected of having underground facilities within the area of proposed excavation. The Washington State Department of Transportation is not a participant in the One Call Center and shall be contracted directly for any work that may impact utilities in the State right of way.

The Contractor shall anticipate that work may be hindered or delayed by:

1. The removal, relocation and adjustment of any utility;
2. Maintenance operations of existing utility systems; or
3. The requirements of the owners of existing utility systems.

The Contractor shall not be entitled to an extension of time or to any claim for damages because of hindrances or delays caused by these activities.

The following addresses and telephone numbers of utility companies known or suspected of having facilities within the project limits and other pertinent contacts are supplied for the Contractor's convenience:

Kitsap County Public Works  
614 Division Street  
Port Orchard, WA 98366  
(360) 337-5777  
Doug Benoit

Lumen/Century Link  
(720) 888-8568, Office  
Masood Zeerak

Cascade Natural Gas  
6313 Kitsap Way  
Bremerton, WA 98312  
(360) 328-6845, Cell  
(360) 405-4225, Office  
Shawn O'Neill

Puget Sound Energy  
22884 Ryen Dr NW  
Poulsbo, WA 98370  
(360) 394-6646  
Fon Kuo

Comcast  
1225 Sylvan Way  
Bremerton, WA 98310  
(360) 377-8528, Office  
(877) 824-2288, Service  
(800) 424-5555, Buried Cable Location

Kitsap Transit  
60 Washington Avenue, Suite 200  
Bremerton, WA 98337  
(360) 479-6966  
Kathryn Jordan

Lumen/Century Link (253) 313-3666, Office  
(360) 626-0263, Cell

Lumen/Century Link Raymond Jones (425) 480-1204, Cell  
Don Twiggs

North Perry Water District  
Andrew Cook  
(360) 373-9508

Silverdale Water District  
5300 NW Newberry Hill Rd Silverdale, WA 98383  
(360) 447-3513  
Michael W. Pleasants

Kitsap Public Utility District  
(360)626-7725  
Mike Flaherty

**1-07.18 Public Liability and Property Damage Insurance**

*Section 1-07.18 is deleted and replaced with the following:  
(Local Agency SP):*

**1-07.18 Insurance****1-07.18(1) General Requirements**

The Contractor shall obtain the insurance described in this section from insurers that are licensed to do business in the state of Washington with a rating of A-: VII or higher in the A.M. Best's Key Rating Guide. The Contracting Agency reserves the right to approve or reject the insurance provided, based on the insurer (including financial condition), terms and coverage, the Certificate of Insurance, and/or endorsements.

The Contractor's insurance shall apply separately to each insured against whom a claim is made or suit is brought, except with respect to the limits of the insurer's liability.

The insurance limits mandated for any insurance coverage required by this Contract are not intended to be an indication of exposure nor are they limitations on indemnification.

The Contractor shall keep this insurance in force during the term of the contract and for thirty (30) days after the Physical Completion date, unless otherwise indicated. Certificates, policies, and endorsements expiring before completion of services shall be promptly replaced as well as the verification sent to the Contracting Agency.

If any insurance policy is written on a claims-made form, its retroactive date, and that of all subsequent renewals, shall be no later than the effective date of this Contract. The policy shall state that coverage is claims made, and state the retroactive date. Claims-made form coverage shall be maintained by the Contractor for a minimum of 36 months following the Final Completion or earlier termination of this contract, and the Contractor shall annually provide the Contracting Agency with proof of renewal. If renewal of the claims made form of coverage becomes unavailable, or economically prohibitive, the Contractor shall purchase an extended reporting period (“tail”) or execute another form of guarantee acceptable to the Contracting Agency to assure financial responsibility for liability for services performed.

The insurance policies shall contain a “cross liability” or “separation of insureds” provision.

The Contractor’s and all subcontractors’ insurance coverage shall be primary and non-contributory insurance as respects the Contracting Agency’s insurance, self-insurance, or insurance pool coverage.

The Contractor shall provide written notice to the Contracting Agency and all Additional Insureds of any policy cancellation, expiration, or material reduction in coverage within two (2) business days of the Contractor’s receipt of such notice.

Written notice of any cancellations or changes in coverage shall be mailed to the Contracting Agency at the following address:

Attn: Risk Manager  
Department of Administrative Services  
614 Division Street  
Port Orchard, Washington 98366

Upon request, the Contractor shall forward to the Contracting Agency a full and certified copy of the insurance policy(s).

The Contractor shall not begin work under the contract until the required insurance has been obtained and approved by the Contracting Agency.

Failure on the part of the Contractor to maintain the insurance as required shall constitute a material breach of contract, upon which the Contracting Agency may, after giving five business days notice to the Contractor to correct the breach, immediately terminate the contract or, at its discretion, procure or renew such insurance and pay any and all premiums in connection therewith, with any sums so expended to be repaid to the Contracting Agency on demand, or at the sole discretion of the Contracting Agency, offset against funds due the Contractor from the Contracting Agency.

All costs for insurance shall be incidental to and included in the unit or lump sum prices of the contract and no additional payment will be made.

**1-07.18(2) Additional Insured**

All insurance policies, with the exception of Professional Liability and Workers Compensation, shall name the following listed entities as additional insured(s) with respect to performance of services:

1. The Contracting Agency and its officers, elected officials, employees, agents, and volunteers;
2. The Contracting Agency’s consultant, Murraysmith, Inc. and its subconsultants;
  - a. Landau Associates, Inc.
  - b. AES Consultants, Inc.
  - c. Casseday Consulting
  - d. Applied Professional Services
  - e. Cascadia Archaeology, LLC.
3. The Contracting Agency’s Special Inspection and Testing consultant.

The above-listed entities shall be additional insureds for the full available limits of liability maintained by the Contractor, whether primary, excess, contingent or otherwise, irrespective of whether such limits maintained by the Contractor are greater than those required by this Contract, and irrespective of whether the Certificate of Insurance provided by the Contractor pursuant to 1-07.18(3) describes limits lower than those maintained by the Contractor.

A failure to comply with reporting provisions of the policies shall not affect coverage provided to the above listed entities.

**1-07.18(3) Subcontractors**

Contractor shall ensure that each subcontractor of every tier obtains and maintains at a minimum the insurance coverages listed herein. Upon request of the Contracting Agency, the Contractor shall provide evidence of such insurance.

**1-07.18(4) Evidence of Insurance**

The Contractor shall deliver to the Contracting Agency a properly executed Certificate(s) of Insurance and/or signed policy endorsements for each policy of insurance meeting the requirements set forth herein when the Contractor delivers the signed Contract for the work. The certificate and endorsements must conform to the following requirements:

1. An ACORD certificate or a form determined by the Contracting Agency to be equivalent.
2. Copies of all endorsements naming Contracting Agency and all other entities listed in Section 1-07.18(2) as Additional Insured(s), showing the policy number. The Contractor may submit a copy of any blanket additional insured clause from its policies instead of a separate endorsement. A statement of additional insured status on an ACORD Certificate of Insurance shall not satisfy this requirement.
3. Any other amendatory endorsements to show the coverage required herein.
4. Certificates of Insurance shall show the Certificate Holder as Kitsap County and include c/o of the Office or Department issuing the Contract. The address of the Certificate Holder shall be shown as the current address of the Office or Department.

**1-07.18(5) Coverages and Limits**

The insurance shall provide the minimum coverages and limits set forth below. Providing coverage in these stated minimum limits shall not be construed to relieve the Contractor from liability in excess of such limits. All deductibles and self-insured retentions must be disclosed and are subject to approval by the Contracting Agency. The cost of any claim payments falling within the deductible shall be the responsibility of the Contractor.

**1-07.18(5)A Commercial General Liability**

Contractor shall maintain a policy of Commercial General Liability Insurance, including:

1. Per project aggregate
2. Premises/Operations Liability
3. Products/Completed Operations – for a period of one year following final acceptance of the work.
4. Personal/Bodily/Advertising Injury
5. Property damage
6. Contractual Liability
7. Independent Contractors Liability
8. Stop Gap / Employers' Liability

Such policy must provide the following minimum limits:

\$2,000,000	Each Occurrence
\$5,000,000	General Aggregate
\$4,000,000	Products & Completed Operations Aggregate
\$2,000,000	Personal, Bodily, & Advertising Injury, each offence

**Stop Gap / Employers' Liability**

\$1,000,000	Each Accident
\$1,000,000	Disease - Policy Limit
\$1,000,000	Disease - Each Employee

The Commercial General Liability coverage shall not exclude any activity to be performed in fulfillment of this Contract and shall contain no special limitations on the scope of protection afforded any additional insured(s). Specialized forms specific to the industry of the Contractor will be deemed equivalent provided coverage is no more restrictive than would be provided under a standard Commercial General Liability policy, including contractual liability coverage. Coverage shall include liability arising out of activities performed by or on behalf of the Contractor; products and completed operations of the Contractor; or premises owned, leased, or used by the Contractor.

**1-07.18(5)B Automobile Liability**

Automobile Liability for owned, non-owned, hired, and leased vehicles, with an MCS 90 endorsement and a CA 9948 endorsement attached if "pollutants" are to be transported. Such policy(ies) must provide the following minimum limit:

\$1,000,000	combined single limit per occurrence for Bodily Injury and Property Damage
-------------	----------------------------------------------------------------------------

**1-07.18(5)C Workers' Compensation**

The Contractor shall comply with Workers' Compensation coverage as required by the Industrial Insurance laws of the state of Washington. Contractor shall also maintain Employees Liability Coverage with a limit of not less than \$1 million. Contractor shall provide evidence of all coverage to the Contracting Agency.

Contractor shall request that their Washington State Department of Labor and Industries, Workers Compensation Representative send written verification to Kitsap County, within ten (10) calendar days after the effective date of the Contract, that the Contractor is currently paying Workers Compensation.

If work is to be performed on or near any navigable waterway, the Contractor shall be responsible for determining if United States Longshore and Harbor Workers Insurance is applicable for this project and shall be responsible for procuring such if the insurance is determined to be applicable. At no time shall the Contracting Agency or the Engineer be responsible for making this determination.

**1-07.18(5)D Builder's Risk**

Contractor shall purchase and maintain Builder's Risk insurance covering interests of the Contracting Agency, the Contractor, and Subcontractors of every tier, as Named Insureds, in the Work. An Installation Floater instead of Builders Risk is acceptable for renovation projects. Builder's Risk insurance shall be on a special form policy, and shall insure against the perils of fire and extended coverage and physical loss or damage, theft, vandalism, malicious mischief and collapse; and flood and earthquake when shown below. The Builder's Risk insurance shall include coverage for temporary buildings, debris removal, and damage to materials in transit or stored off-site. Such insurance shall cover resulting "soft costs" including but not limited to design costs, licensing fees, architect's and engineer's fees, and costs due to delay in completion.

Builder's Risk insurance shall be written in the amount of the completed value of the project, with no coinsurance provisions. Such policy must provide coverage and deductibles that comply with the following:

**Coverage:**

Total Cost of Project to be Insured: Contractor Bid Price  
Soft Costs: \$2,000,000  
Flood: \$2,000,000  
Earthquake: \$3,000,000

**Deductibles not to exceed:**

Earthquake and Flood: 5% of the Value at Time of Loss, subject to a \$250,000 Minimum  
Earth Movement: 5% of the Value at Time of Loss, subject to a \$250,000 Minimum  
All Other Perils: \$50,000  
Soft Costs: \$50,000, with no more than 7-day waiting period

The Builders Risk insurance covering the work shall have maximum deductibles as listed above for each occurrence. The deductible(s) shall be the responsibility of the Contractor.

The Contractor shall provide the Contracting Agency with a full and certified copy of the insurance policy when the Contractor delivers the signed Contract for the work. Failure of Contracting Agency to demand such verification of coverage with these insurance requirements or failure of Contracting Agency to identify a deficiency from the insurance documentation provided shall not be construed as a waiver of Contractor's obligation to maintain such insurance.

The Builders Risk insurance shall be maintained until final acceptance of the Work by the Contracting Agency.

The Contractor and the Contracting Agency waive all rights against each other and any of their Subcontractors of every tier, agents, and employees, officers, and officials, for damages caused by fire or other perils to the extent covered by Builder's Risk insurance or other property insurance applicable to the work. The policies shall provide such waivers by endorsement.

**1-07.18(5)E Excess or Umbrella Liability**

The Contractor shall provide Excess or Umbrella Liability insurance with limits of not less than 1 million each occurrence and annual aggregate. This excess or umbrella liability coverage shall be excess over and as least as broad in coverage as the Contractor's Commercial General and Auto Liability insurance.

All entities listed under 1-07.18(2) of these Special Provisions shall be named as additional insureds on the Contractor's Excess or Umbrella Liability insurance policy.

This requirement may be satisfied instead through the Contractor's primary Commercial General and Automobile Liability coverages, or any combination thereof that achieves the overall required limits of insurance.

**1-07.18(5)F Pollution Liability**

The Contractor shall provide a Contractors Pollution Liability policy, providing coverage for claims involving bodily injury, property damage (including loss of use of tangible property that has not been physically injured), cleanup costs, remediation, disposal or other handling of pollutants, including costs and expenses incurred in the investigation, defense, or settlement of claims arising out of:

1. Contractor's operations related to this project; and/or
2. Remediation, abatement, repair, maintenance or other work with lead-based paint or materials containing asbestos; and/or
3. Transportation of hazardous materials away from any site related to this project.

All entities listed under 1-07.18(2) of these Special Provisions shall be named by endorsement as additional insureds on the Contractors Pollution Liability insurance policy.

Such Pollution Liability policy shall provide the following minimum coverage:

\$2,000,000 each loss and annual aggregate

This policy shall be endorsed so that “pollutants” definition includes sewage and/or reclaimed water as well as any sewage and/or reclaimed water byproducts. The policy shall also include property damage coverall for natural resource damages (NRD).

**1-07.18(5)G Professional Liability**

The Contractor and/or its Subcontractors and/or its design consultant providing construction management, value engineering, or any other design-related non-construction professional services shall provide evidence of Professional Liability insurance covering professional errors and omissions. Such policy must provide the following minimum limits:

\$1,000,000 per claim and annual aggregate

If the scope of such design-related professional services includes work related to pollution conditions, the Professional Liability insurance shall include coverage for Environmental Professional Liability.

If this insurance policy is written on a claims-made form, its retroactive date, and that of all subsequent renewals, shall be no later than the effective date of this Contract. The policy shall state that coverage is claims made, and state the retroactive date. Claims-made form coverage shall be maintained by the Contractor for a minimum of 36 months following the Final Completion or earlier termination of this contract, and the Contractor shall annually provide the Contracting Agency with proof of renewal. If renewal of the claims made form of coverage becomes unavailable, or economically prohibitive, the Contractor shall purchase an extended reporting period (“tail”) or execute another form of guarantee acceptable to the Contracting Agency to assure financial responsibility for liability for services performed.

**1-07.18(5)H LHWCA Insurance**

If this Contract involves work on or adjacent to Navigable Waters of the United States, the Contractor shall procure and maintain insurance coverage in compliance with the statutory requirements of the U.S. Longshore and Harbor Workers' Compensation Act (LHWCA).

Such policy must provide the following minimum limits:

\$1,000,000 Bodily Injury by Accident – each accident

\$1,000,000 Bodily Injury by Disease – each employee

\$1,000,000 Bodily Injury by Disease – policy limits

**1-07.18(5)I Protection & Indemnity Insurance Including Jones Act**

If this Contract involves marine activities, or work from a boat, vessel, or floating platform, the Contractor shall procure and maintain Protection and Indemnity (P&I) coverage including collision liability, injury to crew (Merchant Marine Act of 1920 - Jones Act) and passengers, removal of wreck and liability for seepage, pollution, containment and cleanup using form SP-23 or SP 38 or a form as least as broad.

All entities listed under 1-07.18(2) of these Special Provisions shall be named as additional insureds on the Contractor’s Protection and Indemnity insurance policy.

Such policy must provide the following minimum limits:

\$1,000,000 Bodily Injury by Accident – each accident or occurrence

\$1,000,000 Bodily Injury by Disease – each employee

\$1,000,000 Bodily Injury by Disease – policy limits

**1-07.18(5)J Hull and Machinery**

If this Contract involves use of a boat, vessel, or floating platform, the Contractor shall procure and maintain coverage at Market Value of vessel on American Institute Hull Clauses, 6/2/77 form.



**1-07.18(5)K Marine Pollution**

The Contractor shall procure and maintain Pollution Liability (OPA, CERCLA) insurance to satisfy U.S. Coast Guard requirements as respects the Federal Oil Pollution Act of 1990 and the Comprehensive Environmental Response, Compensation and Liability Act of 1980 as amended.

Such policy must provide the following minimum limits, or statutory limits of liability as applicable, whichever is higher:

\$1,000,000 per Occurrence

**1-07.23 Public Convenience and Safety**

*Section 1-07.23 is supplemented with the following:  
(Local Agency SP)*

The Contractor shall be responsible to notify, in writing, local fire, school (South Kitsap School District), law enforcement authorities, Kitsap Transit, Paratransit Services, or other affected persons, not less than ten (10) working days prior to construction operations that will deviate and/or delay traffic from the existing traffic pattern, so that these agencies may reroute emergency or other vehicles and may revise bus stops as necessary.

The Contractor shall at all times conduct the work as to insure the least possible obstruction to traffic and inconvenience to the general public and the residents in the vicinity of the work, and to insure the protection of persons and property. No road or street shall be closed to the public except with the permission of the Engineer and proper governmental authority. Contractor shall be aware that any road closures that last more than 12 hours will require approval by the County Commissioners prior to the closure. Obtaining that approval can take up to 8 weeks.

Fire hydrants on or adjacent to the work shall be kept accessible to firefighting equipment at all times. Temporary provisions shall be made by the Contractor to insure the use of sidewalks and private and public driveways, and the proper functioning of all gutters, sewer inlets, drainage ditches and culverts, irrigation ditches and natural water courses. Access must be maintained for foot and bus traffic to nearby schools.

The Contracting Agency and controlling public authorities shall be notified at least 24 hours in advance of any actions by the Contractor which may affect the functions of the police or fire departments, school system, or water and sewer districts.

The Contractor shall conduct the work and take preventative measures such that dust in the project area shall not become objectionable to the adjacent property owners. Should the Contracting Agency determine the Contractor is not fulfilling this obligation; the Contracting Agency reserves the right to take such action as may be necessary and to charge the Contractor for any costs that may be incurred in such remedial action.

All work shall be conducted with due regard for the safety of the public. Open trenches shall be completely backfilled or covered prior to the stop of work each day and provided with barricades of a type that can be seen at a reasonable distance, and at night they shall be distinctly indicated by adequately placed lights. Safety instructions received from the Engineer, Controlling Agency, or the Contracting Agency shall be observed, but the following of such instructions shall in no way relieve the Contractor of his responsibility or liability should any accident or loss occur as the result of the construction operations. Flaggers shall be provided by the Contractor as required to direct traffic.

It shall be the Contractor's responsibility to see that all requirements of the Federal William-Stieger Occupational Safety and Health Act as well as the State of Washington Industrial Safety and Health Act, are observed and enforced to protect all the workmen on the project as well as the general public.

Complaints received by the Contracting Agency concerning public inconvenience or safety hazards will be referred to the Contractor for immediate corrective action. In addition to normal work hours, corrective actions may need to be taken on Saturdays, Sundays, holidays, and at times other than normal work hours.

**1-07.23(1) Construction under Traffic**

*The second paragraph of Section 1-07.23(1) is revised to read as follows:  
(Local Agency SP)*

To disrupt public traffic as little as possible, the Contractor shall permit traffic to pass through the work with the least possible inconvenience or delay. The Contractor shall maintain existing roads, streets, sidewalks, and paths within the project limits, keeping them open, and in good, clean, safe condition at all times. If there is need to temporarily block access, such blockages shall be coordinated with the Contracting Agency, the affected property owners, and the Engineer. Deficiencies caused by the Contractor's operations shall be repaired at the Contractor's expense. Deficiencies not caused by the Contractor's operations shall be repaired by the Contractor when directed by the Engineer, at the Contracting Agency's expense. The Contractor shall also maintain roads, streets, sidewalks, and paths adjacent to the project limits when affected by the Contractor's operations. Snow and ice control will be performed by the Contracting Agency on all projects. Cleanup of snow and ice control debris will be at the Contracting Agency's expense. The Contractor shall perform the following:

1. Remove or repair any condition resulting from the work that might impede traffic or create a hazard.
2. Keep existing traffic signal and highway lighting systems in operation as the work proceeds. The Contracting Agency will remain responsible for the routine maintenance on such systems.
3. Maintain the striping on the roadway. The Contractor shall be responsible for scheduling when to renew striping, subject to the approval of the Engineer. When the scope of the project does not require work on the roadway, the Contracting Agency will be responsible for maintaining the striping.
4. Maintain existing permanent signing. Repair of signs will be at the Contracting Agency's expense, except those damaged due to the Contractor's operations.
5. Keep drainage structures clean to allow for free flow of water. Cleaning of existing drainage structures will be at the Contracting Agency's expense except when flow is impaired due to the Contractor's operations. Contractor shall be responsible for cleaning existing drainage structures that have been impaired by the Contractor's work.
6. All trenches within the right of way shall be backfilled completely and the surface restored to a good, clean, safe and drivable condition before leaving the site after each day's work. The Contractor may leave the trench open if steel sheets coated with asphalt are installed and properly wedged with cold mix to provide a smooth transition.

Contractor shall maintain pedestrian and vehicular traffic around the work areas at all times. The Contractor shall also maintain ingress and egress to local businesses at all times. The Contractor shall submit a traffic control plan for review and acceptance prior to construction. The traffic control plan shall clearly show the type, location and spacing of all traffic control devices. The Contractor shall maintain detour signing and changeable message signs (CMS) for the approved detour throughout the duration of the work. The traffic control plan shall be updated as needed as work progresses. The Contractor shall be held liable for all claims resulting from the improper installation and/or maintenance of the detour and traffic control plans.

**1-07.24 Rights of Way**

*Section 1-07.24 is supplemented with the following:  
(Local Agency SP)*

Street right of way lines, limits of easements, and limits of construction permits are indicated on the Plans. The Contractor's construction activities shall be confined within these limits, unless arrangements for use of private property are made by Contractor.

Generally, the Contracting Agency has obtained, prior to bid opening, all rights of way and easements, both permanent and temporary, necessary for carrying out the work. Exceptions to this are noted herein or will be brought to the Contractor's attention by a duly issued Addendum.

Whenever any of the work is accomplished on or through property other than public right of way, the Contractor shall meet and fulfill all covenants and stipulations of any easement agreement obtained by the Contracting Agency from the owner of the private property. The following table summarizes the easements that have been acquired and any special conditions. This information is provided for convenience, and the Contractor shall be aware of, and comply with all special conditions contained in the easement documents whether they are listed in this table or not. The Temporary Construction Easements and Sewer Easements are provided in Appendix E.

<b>Owner</b>	<b>Parcel No.</b>	<b>Special Conditions</b>
<b>Temporary Construction Easements/Sewer Easements</b>		
Clear Creek MHP LLC	332601-3-008-2002	
Hill Charity A	332601-3-011-2007	
Stewart Zachary Andrew	332601-3-012-2006	
Foris Keith and Jody	332601-3-013-2005	
Country Commons Homeowners Association	5309-000-023-0000	
Clauson Donald N	332601-3-016-2002	
Clauson Donald N	332601-3-015-2003	
Moran Gerardo C	332601-3-039-2005	
Liam Carter and Laura Reachard	352601-4-016-2008	
Keith Hawryluk	5060-000-033-0007	
Lance and Karen Oldham	352601-4-063-2000	
Jeffrey and Rebecca Kehring	5060-000-032-0008	
Michael and Lynn Decker	352601-4-002-2004	

Each property owner shall be given 2 working days notice prior to entry by the Contractor. This includes entry onto easements and private property where private improvements must be adjusted.

The Contractor shall be responsible for providing, without expense or liability to the Contracting Agency, any additional land and access thereto that the Contractor may desire for temporary construction facilities, storage of materials, treatment/disposal of dewatering water, or other Contractor needs. However, before using any private property, whether adjoining the work or not, the Contractor shall file with the Engineer a written permission of the private property owner, and, upon vacating the premises, a written release from the property owner of each property disturbed or otherwise interfered with by reasons of construction pursued under this contract. The statement shall be signed by the private property owner, or proper authority acting for the owner of the private property affected, stating that permission has been granted to use the property and all necessary permits have been obtained or, in the case of a release, that the restoration of the property has been satisfactorily accomplished. The statement shall include the parcel number, address, and date of signature. Written releases must be filed with the Engineer before the Final Completion Date will be established.

**1-07.28 Haul Route Restrictions**

*Section 1-07.28 is added as the following:  
(Local Agency SP)*

The Contractor shall contact all governing control agencies who have jurisdiction over proposed routes that will be used for the delivery and removal of materials for the project prior to bid. The Contractor shall follow the requirement(s) of the controlling agency and shall include the cost of complying with any such requirements in the applicable unit price per or lump sum bid item. No separate or additional payment will be made for regulatory agencies request for vehicle routing.

The Contractor shall submit a traffic control plan to all appropriate controlling agencies for hauling of import materials and excavation materials. The Contractor shall amend and abide by comments on the approved traffic control plan.

All roads shall be open to vehicular traffic after the completion of each day's construction activity. Steel plates, temporary fill, barricades and other measures shall be used to make disturbed roads safe and passable. Road closures (if allowed) shall be posted at least one week prior to the start of construction.

**END OF SECTION 1-07**

THIS PAGE INTENTIONALLY LEFT BLANK

**1-08 Prosecution and Progress****1-08.0 Preliminary Matters**

*Section 1-08.0 and its subsections are added as the following:  
(Local Agency SP)*

**1-08.0(1) Preconstruction Public Meeting**

Prior to the Contractor beginning work, the Contracting Agency will hold a public meeting for property owners that will or may be affected by the project. Contracting Agency representatives, the Engineer, and the Contractor (project manager and superintendent) will attend this preconstruction public meeting. The purpose of this meeting is to introduce the project team; discuss the project; listen to, and address the public's concerns; and obtain input and answer the public's questions,

**1-08.0(2) Preconstruction Conference**

Prior to the Contractor beginning the work, a preconstruction conference will be held between the Contractor, Contracting Agency, Engineer and such other interested parties as may be invited. The purpose of the preconstruction conference will be:

1. To review the initial progress schedule;
2. To establish a working understanding among the various parties associated or affected by the work;
3. To establish and review procedures for progress payment, notifications, approvals, submittals, etc.;
4. To establish normal working hours for the work;
5. To review safety standards and traffic control; and
6. To discuss such other related items as may be pertinent to the work.

The Contractor shall prepare and submit at the preconstruction conference the following:

1. A breakdown/schedule of values for all lump sum items;
2. A preliminary schedule of shop drawings and submittals;
3. A preliminary construction schedule. See Section 1-08.3
4. A preliminary dewatering plan. See Section 7-08.
5. A list of material sources for acceptance if applicable.

**1-08.0(2) Hours of Work**

Except in the case of emergency or unless otherwise approved by the Contracting Agency, or shown on the Drawings the normal straight time working hours for the contract shall be any consecutive 8-hour period between 7:00 a.m. and 6:00 p.m. of a working day with a maximum 1-hour lunch break and a 5-day work week. The normal straight time 8-hour working period for the contract shall be established at the preconstruction conference or prior to the Contractor commencing the work.

Written permission from the Engineer is required, if a Contractor desires to perform work on holidays, Saturdays, or Sundays; before 7:00 a.m. or after 6:00 p.m. on any day; or longer than an 8-hour period on any day. The Contractor shall apply in writing to the Engineer for such permission, no later than 72 hours prior to the day for which the Contractor is requesting permission to work.

Permission to work between the hours of 10:00 p.m. and 7:00 a.m. during weekdays and between the hours of 10:00 p.m. and 9:00 a.m. on weekends or holidays may also be subject to additional noise control requirements. Approval to continue work during these hours may be revoked at any time the Contractor exceeds the Contracting Agency's noise control regulations or complaints are received from the public or adjoining property owners regarding the noise from the Contractor's operations.

During the Bald Eagle nesting season (January 1 through August 15), construction hours are constrained to no earlier than one hour after dawn and no later than one hour before dusk.

The Contractor shall have no claim for damages or delays should such permission be revoked for these reasons.

Permission to work Saturdays, Sundays, holidays or other than the agreed upon normal straight time working hours Monday through Friday may be given subject to certain other conditions set forth by the Contracting Agency or Engineer. These conditions may include but are not limited to:

1. The Engineer may require designated representatives to be present during the work. Representatives who may be deemed necessary by the Engineer include, but are not limited to: survey crews; personnel from the Contracting Agency's material testing lab; inspectors; and other Contracting Agency employees when in the opinion of the Engineer, such work necessitates their presence.
2. Requiring the Contractor to reimburse the Contracting Agency for the costs in excess of straight-time costs for Contracting Agency during such times.
3. Considering the work performed on Saturdays, Sundays, and holidays as working days with regards to the contract time.\*
4. Considering multiple work shifts as multiple working days with respect to contract time even though the multiple shifts occur in a single 24-hour period.\*

**1-08.0(3) Reimbursement for Overtime Work of Contracting Agency Employees**

Where the Contractor elects to work on a Saturday, Sunday, or holiday, or longer than an 8-hour work shift on a regular working day, as defined in the Standard Specifications, such work shall be considered as overtime work. On all such overtime work, a construction observer may be present, and possibly others may be required at the discretion of the Contracting Agency and Engineer. In such case, the Contracting Agency may deduct the costs in excess of the straight-time costs incurred by the Contracting Agency for the overtime hours. The Contractor authorizes the Engineer to deduct such costs from the amount due or to become due to the Contractor.

**1-08.3 Progress Schedule**

**1-08.3(1) General Requirements**

*Section 1-08.3(1) is supplemented with the following:  
(Local Agency SP)*

Contractor shall solicit input on manufacturing and delivery times from critical, long-lead and/or significant equipment and material suppliers and subcontractors. Critical and long-lead equipment or materials shall be identified and scheduled, and will include, but not be limited to, the following:

1. Custom vaults and manhole structures
2. HDPE Pipe and Fittings
3. Ductile Iron Pipe and Fittings

Once the preliminary schedule is accepted by the Engineer, all subcontractors shall be made aware and sign off on the schedule. This will be done and documented early on at a weekly construction meeting.

To accommodate the desired information and the required schedule updates, Contractor shall use the latest revision of Primavera systems (Primavera P6) to perform scheduling functions. The Contractor's attention is directed to the format/content of the schedule of values. Given appropriate consolidation and expansion, this list shall serve as a starting point. The project schedule shall be in sufficient detail that progress of the Work can be evaluated accurately at any time during the performance of the contract.



The Contractor shall employ a person or firm with at least ten years of construction and scheduling experience who is qualified to prepare detailed construction schedules. Evidence of construction experience and successful scheduling (i.e., work completed on schedule) on at least three (3) projects in the last five years shall be provided. Provide schedules and contact information for each of the projects. Contractor shall provide Engineer with resume and other pertinent information on the proposed scheduler. If the Engineer determines that the qualifications are not met, the Engineer can direct the Contractor to provide a different scheduler that meets the qualifications at no additional cost to the Contracting Agency.

The schedule shall begin with the date of issuance of the Notice to Proceed and conclude with the date of the final completion. The total float belongs to the project and shall not be for the exclusive use or benefit of any party.

The project schedule shall be updated monthly and the Contractor shall submit one (1) PDF copy and one (1) backup copy of the schedule using the backup routine provided in the scheduling software. Processing of pay requests will be contingent upon receipt of updated schedules. In addition to the project schedule, the Contractor shall submit a written two week outlook activity schedule to the Engineer at the weekly progress meetings. The activity schedule shall indicate the Contractor's proposed activities for the forthcoming two weeks. Submittal of the weekly schedule does not relieve the Contractor of the requirement to submit and update the project schedule as required herein.

Time is of the essence on this project. Therefore, should schedule slippage occur, the Contractor is required to take appropriate measures to get the project back onto the approved schedule. The Contractor will not be allowed to continually let the schedule slip. Contractor shall adjust his forces, equipment and work schedules as may be necessary to get the project back on schedule to ensure completion of the work within the prescribed contract time. Contractor shall provide a plan of action and execute it accordingly to the satisfaction of the Engineer. Failure to do so will result in delay of progress payment(s) and/or a reduction in progress payment(s).

#### **1-08.3(2)A Type A Progress Schedule**

*Section 1-08.3(2)A is revised to read as follows:  
(Local Agency SP)*

A Type A progress schedule will not be accepted by the Engineer.

#### **1-08.3(2)B Type B Progress Schedule**

*The first paragraph and the first sentence of the second paragraph of Section 1-08.3(2)B are revised to read as follows:  
(Local Agency SP)*

The Contractor shall submit a preliminary Type B Progress Schedule depicting the entire project prior to the preconstruction conference. The preliminary Type B Progress Schedule shall comply with all of these requirements and the requirements of Section 1-08.3(1).

The Contractor shall submit four (4) hard copies, one (1) PDF copy and one (1) backup copy using the backup routine provided in the scheduling software of the revised Type B Progress Schedule depicting the entire project no later than 21-calendar days after the preconstruction conference. Contractor shall address all of the Engineer's comments on the preliminary Type B Progress Schedule.

*The last paragraph of Section 1-08.3(2)B is revised to read as follows:  
(Local Agency SP)*

The Engineer will evaluate the Type B Progress Schedule and accept or return the schedule for corrections within 15 calendar days of receiving the submittal. The accepted Type B Progress Schedule shall establish the baseline schedule. The preliminary construction schedule shall remain in effect until the baseline schedule is accepted by the Engineer. Acceptance of the Type B Progress Schedule is for general compliance of the contract requirements and does not impose upon the Contracting Agency any warranty that all contract requirements have been addressed, met, or modified in the schedule. If it is determined that the schedule did not include modified contract requirements, the Contractor will modify its schedule without affecting the Contract Time at no additional cost to the Contracting Agency.

**1-08.3(2)C Construction Sequencing and Constraints**

*Section 1-08.3(2)C is added as the following:  
(Local Agency SP)*

Continuous operation of the Contracting Agency's facilities is of critical importance. The Contractor shall schedule and conduct activities to enable existing facilities to operate continuously, unless otherwise specified. The Contractor shall not proceed with work affecting a facility's operation without obtaining Contracting Agency's and Engineer's advance written approval of the need for, and duration of, such work.

Where existing facilities are to be modified during the course of work, the Contractor shall obtain Engineer's review of submittals for temporary shutdown, demolition, modification, connections between new and existing work, and other related work and shall conform to other Contract conditions as applicable.

The Contractor shall be responsible for developing the sequence of the work and for ensuring that current operations are not interrupted or compromised.

At least two weeks prior to starting the work, Contractor shall coordinate with the Engineer and Contracting Agency's representative to develop a work schedule which will permit facilities to function as normally as practical. A portion of the construction work will be required outside normal working hours to avoid undesirable conditions. The Contractor shall do this work at such times and at no additional cost to the Contracting Agency. Connections between existing facilities and new work shall not be made until all necessary inspection and tests have been completed on the new work and the new work is found to conform in all respects to the requirements of the Contract Documents.

Connection to existing services or utilities, or other work that requires temporary shutdown of any existing operations or utilities, shall be planned in detail with appropriate scheduling of the work and coordinated with the Contracting Agency or Engineer. The approved schedule for shutdown or restart shall be indicated on the Contractor's Progress Schedule, and at least seven (7) calendar days of advance written notice shall be given to the Contracting Agency and Engineer so that they may witness the shutdown, tie-in, and startup.

The Contracting Agency and Engineer consider the Contractor's schedule and construction sequencing to be paramount to ensure that the work is properly planned, coordinated, and executed. A number of pump stations feed or are fed by the facilities that will be replaced by the work under this contract. Those pump stations are currently and continuously receiving and pumping sewage and their functions shall not be interrupted except as specified herein or as specifically allowed by Contracting Agency. The Contractor shall properly coordinate and execute the work to avoid interference with normal operations. Work during low flow periods (between the hours of 12 am and 5 am) and sewer bypassing will be required to complete portions of the work. Such work shall be minimized to the extent possible through proper sequencing and execution of the work.

**1-08.3(2)E Weekly Progress Meetings**

*Section 1-08.3(2)E is added as the following:  
(Local Agency SP)*

To enable orderly review during progress of the work, and to provide for systematic discussion of problems, the Engineer will conduct weekly progress meetings with the Contractor throughout the construction period. The purpose of the meetings will be to review the progress of the Work, maintain coordination of efforts, discuss changes in scheduling and resolve other problems that may develop.

**Agenda Items**

The Contractor shall, to the maximum extent practicable, advise the Engineer at least 24 hours in advance of project meetings regarding items to be added to the agenda.

**Minutes**

The Engineer will compile a summary of the discussion of each project meeting and will furnish copies to the Contracting Agency and Contractor. Recipients of copies may make and distribute copies as they deem necessary.

**Attendance**

These meetings shall be conducted by the Engineer and shall be attended by the Contractor's superintendent and representatives of electrical subcontractors, utilities and/or others that are active or critical in the planning or execution of the pending work. The Contractor may invite subcontractors, materials or equipment suppliers, and others to attend project meetings in which their aspect of the work is involved.

**Meeting Schedule and Location**

Progress meetings will be held weekly. Engineer and Contractor will establish a mutually acceptable day and time for meetings. Meetings will be held at the **Central Kitsap Treatment Plant** unless mutually agreed upon otherwise.

**Agenda**

A minimum agenda for these meetings is as follows:

1. Review, and revise as necessary, minutes of previous meetings and status of previously identified action items.
2. Review progress of the work since last meeting, including status of submittals for review.
3. Discuss any issues or deficiencies with the work and necessary corrective action.
4. Discuss scheduling of any required Special Inspections or tests associated with work to be completed.
5. Review status of equipment and materials fabrication/shipments.
6. Identify issues that impede planned progress, or which impact operations of existing facilities.
7. Compare status of completion to detailed schedule and identify any activities that are behind schedule. Discuss corrective measures and procedures to regain schedule.
8. Review temporary water pollution/erosion control.
9. Review outstanding contract change issues and claims.
10. Review design modifications and documentation for change orders. Discuss any cost or schedule impacts.
11. Verify Contractor's record drawings are current.
12. Review progress payment requests.

Unless published minutes are challenged in writing prior to the next regularly scheduled progress meeting, they will be accepted as properly stating the discussions and decisions of the meeting.

Persons challenging published minutes shall reproduce and distribute copies of the challenge to all indicated recipients of the particular set of minutes.

Challenges to minutes shall be settled as a priority portion of "old business" at the next regularly scheduled meeting.

**1-08.3(3) Schedule Updates**

*The first paragraph of Section 1-08.3(3) is revised to read as follows:  
(Local Agency SP)*

Contractor shall submit updated schedules on a monthly basis. In addition, the Engineer may request a schedule update when any of the following events occur:

1. The project has experienced a change that affects the critical path.
2. The sequence of work is changed from that in the approved schedule.
3. The project is significantly delayed.
4. Upon receiving an extension of Contract time.

**1-08.4 Prosecution of Work**

*Delete this section and replace it with the following:  
(July 23, 2015 APWA GSP)*

Notice to Proceed will be given after the contract has been executed and the contract bond and evidence of insurance have been approved and filed by the Contracting Agency. The Contractor shall not commence with the work until the Notice to Proceed has been given by the Engineer. The Contractor shall commence construction activities on the project site within ten days of the Notice to Proceed Date, unless otherwise approved in writing. The Contractor shall diligently pursue the work to the physical completion date within the time specified in the contract. Voluntary shutdown or slowing of operations by the Contractor shall not relieve the Contractor of the responsibility to complete the work within the time(s) specified in the contract.

When shown in the Plans, the first order of work shall be the installation of high visibility fencing to delineate all areas for protection or restoration, as described in the Contract. Installation of high visibility fencing adjacent to the roadway shall occur after the placement of all necessary signs and traffic control devices in accordance with 1-10.1(2). Upon construction of the fencing, the Contractor shall request the Engineer to inspect the fence. No other work shall be performed on the site until the Contracting Agency has accepted the installation of high visibility fencing, as described in the Contract.

**1-08.5 Time for Completion**

*The first paragraph of Section 1-08.5 is supplemented with the following:  
(Local Agency SP)*

If the Contractor performs work on a day that is classified as a non-working day, then that day shall be reclassified as a working day and counted towards the Contract time.

*The third and fourth paragraphs of Section 1-08.5 are deleted and replaced with the following:  
(Local Agency SP)*

Contract time for the Preconstruction Phase Work shall begin on the working day identified in the Limited Notice to Proceed. Each working day shall be charged to the contract as it occurs, until the Preconstruction Phase work is physically complete. Each week the Engineer will provide the Contractor a statement that shows the number of calendar days: (1) charged to the contract the week before; and (2) specified for the completion of the Preconstruction Phase work. The statement will also show the nonworking days and any partial or whole day the Engineer declares as unworkable.

Contract time for the Construction Phase Work shall begin on the working day identified in the Notice to Proceed with Construction. Each working day shall be charged to the contract as it occurs, until the Construction Phase contract work is physically complete. Each week the Engineer will provide the Contractor a statement that shows the number of working days: (1) charged to the contract the week before; (2) specified for the physical completion of the contract; and (3) remaining for the physical completion of the contract. The statement will also show the nonworking days and any partial or whole day the Engineer declares as unworkable.

The statements shall be deemed accepted and correct unless the Contractor files a written protest of any alleged discrepancies in the statement within 10 calendar days after the date of each statement. To be considered by the Engineer, the protest shall be in sufficient detail to enable the Engineer to ascertain the basis and amount of time disputed. If the Contractor elects to work 10 hours a day and 4 days a week (a 4-10 schedule) and the fifth day of the week in which a 4-10 shift is worked would ordinarily be charged as a working day then the fifth day of that week will be charged as a working day whether or not the Contractor works on that day.

*The sixth paragraph and the subparagraphs of Section 1-08.5 are deleted and replaced with the following:  
(Local Agency SP)*

The Engineer will give the Contractor written notice of the completion date of the contract after all the Contractor's obligations under the contract have been performed by the Contractor. The following events must occur prior to establishing the Completion Date:

1. The physical work on the project must be complete; and
2. The Contractor must furnish all documentation required by the contract and required by law, to allow the Contracting Agency to process final acceptance of the contract. The following documents must be received by the Project Engineer prior to establishing a completion date:
  - a. Final Contract Voucher Certification
  - b. Copies of the approved "Affidavit of Prevailing Wages Paid" for the Contractor and all Subcontractors.
  - c. Property owner releases per Section 1-07.24
  - d. A copy of the Notice of Termination sent to the Washington State Department of Ecology (Ecology); the elapse of 30 calendar days from the date of receipt of the Notice of Termination by Ecology; and no rejection of the Notice of Termination by Ecology. This requirement will not apply if the Construction Stormwater General Permit is transferred back to the Contracting Agency in accordance with WSDOT Standard Specification [Section 8-01.3\(16\)](#)

*Section 1-08.5 is supplemented with the following:  
(Local Agency SP)*

The project has the following critical completion date milestones:

1. Completion of Preconstruction Phase Work. All work under the Preconstruction Phase of this Contract shall be completed within **75** working days after the Limited Notice to Proceed Date.
2. Substantial Completion. All work under this Contract shall be substantially complete within **405 calendar\*** days after the Notice to Proceed Date.
3. Physical Completion. All work under this Contract shall be physically complete within **435 calendar\*** days after the Notice to Proceed Date.

The Contractor is cautioned that part of the work in this Contract may be performed only during certain periods of the day (e.g., connections to the existing sanitary sewer system, bald eagle nesting restrictions established by permit conditions), certain times of the year (e.g., WDFW Fish Window restrictions established by permit conditions) and favorable weather conditions, and as such, the Contractor shall plan and execute the work accordingly. Liquidated damages will be applied to any working days that exceed the time frames stipulated above.

**1-08.8(1) Abnormal Weather Conditions**

*Section 1-08.8(1) is added as follows:  
(Local Agency SP)*

Precipitation as rain, hail or snow, low temperature, a windstorm, ice, snow and other weather conditions which could reasonably have been anticipated from the National Weather Service historical records of the general locality of the work shall not be construed as abnormal. It is hereby agreed that precipitation greater than the following, temperatures less than the following, and wind velocities greater than the following, cannot be reasonably anticipated. For each day determined to be abnormal as determined by the Construction Manager and approved by the Owner, one day shall be added to the contract duration at no additional cost to the Owner by written change order.

1. Daily rainfall equal to or greater than 0.50 inches during a month when the monthly rainfall exceeds the normal monthly average by 15 to 100 percent.
2. Daily rainfall equal to or greater than 0.20 inches during a month when the monthly rainfall exceeds the normal monthly average by more than 100 percent.
3. Daily rainfall equal to or greater than 1.0 inch at any time.
4. Daily maximum temperature equal to or less than 20 degrees F during a week when the maximum daily temperature never exceeds 35 degrees F.
5. Daily maximum temperature equal to or less than 25 degrees F during a week when the maximum daily temperature never exceeds 30 degrees F.
6. Daily maximum temperature equal to or less than 15 degrees F at any time.
7. Daily maximum wind velocity equal to or greater than 50 mph at any time.

Ice, snow and other weather conditions may be considered as abnormal in the sole discretion of the Construction Manager upon written request by the Contractor. Such written request shall describe in detail the weather condition, identify the specific impacts resulting from the weather condition, and be submitted to the Construction Manager within five days of the onset of the weather condition.

To preclude the difficulties of actual measurement, the parties hereto agree that weather data at the site of the work shall be expressly deemed to be the same as that measured at the Seattle-Tacoma International Airport by the Environmental Data and Information Service of the National Oceanic and Atmospheric Administration ("NOAA") of the U.S. Department of Commerce.

For the purposes of this section, a "month" shall mean a calendar month and a "week" shall mean a calendar week of Sunday through Saturday.

**1-08.9 Liquidated Damages**

*The third paragraph of Section 1-08.9 is revised as follows:  
(Local Agency SP)*

Replace all references to "Physical Completion" with the words "Substantial Completion."

*The fourth paragraph of Section 1-08.9 is deleted and replaced with the following:  
(Local Agency SP)*

When the Contract Work has progressed to the extent that the Engineer has determined the Contract Work is substantially complete, the Engineer will notify the Contractor in writing of the Substantial Completion Date. For overruns in contract time occurring after the substantial completion date, the formula for liquidated damages shown above will not apply. Liquidated damages shall be assessed at two thousand five hundred (\$2,500) dollars per day until substantial completion is achieved. When the Contract Work is physically complete, the Engineer will notify the Contractor in writing of the Physical Completion Date. For overruns in contract time occurring after the physical completion date, actual damages will be assessed based on the direct engineering, Contracting Agency, and other related costs assignable to the project that are incurred by the Contracting Agency until the Contractor has fulfilled all the obligations under the Contract and submitted all documentation required by the Contract and the law

and the Engineer establishes the Final Completion Date. The Contracting Agency may offset these costs against any payment due Contractor. Contractor shall complete the remaining work that is subject to liquidated damages as promptly as possible. Upon request by the Engineer, the Contractor shall furnish a written schedule for completing the remaining physical work on the Contract.

**1-08.10 Termination of Contract**

*Section 1-08.10 is supplemented with the following:  
(Local Agency SP)*

In the event that funding for this project is withdrawn, reduced or limited in any way after the effective date of this Contract, the Contracting Agency may summarily terminate this Contract notwithstanding any other termination provision of this Contract. Termination under this paragraph shall be effective upon the date specified in the written notice of termination sent by the Contracting Agency to the Contractor. After the effective date, no charges incurred under this Contract are allowable.

**END OF SECTION 1-08**

THIS PAGE INTENTIONALLY LEFT BLANK



**1-09 Measurement and Payment****1-09.1 Measurement of Quantities**

*Section 1-09.1 is revised with the following:  
(Local Agency SP)*

Delete the tenth paragraph beginning with the words "Linear Foot..." and replace with the following:

**Linear Foot** - Linear feet shall be measured along the pipe alignment and shall include the length through the elbows, tees, and fittings for the pay limits as shown on the Drawings. No adjustments will be made in the length for the slope, uneven contours, overlap of materials, repairs or wasted material.

**1-09.2(1) General Requirements for Weighing Equipment**

*Section 1-09.2(1) is supplemented with the following:  
(Local Agency SP)*

The Contractor shall notify the Engineer not less than one working day prior to delivering materials which are measured and paid for by weight on the project. Certified weights must be issued at the source.

The Contractor shall provide a licensed public weigh master. The licensed weigh master shall issue weight tickets to the truck driver for acceptance of the material on the project by the Engineer. No materials measured and paid for by weight will be accepted without certified weight tickets from a platform scale in accordance with Section 1-09.2(3). The certified weight tickets shall be given to the Project Inspector on the day of delivery for each truckload delivered. Pay quantities will be prepared on the basis of these weight tickets, and tickets not received by the Inspector will not be honored for payment.

Truck loads must conform to legal load limits. In case of overload, the difference between overload and maximum legal load will not be paid for. If there are repeated instances of overloading, the proper enforcement authorities will be notified.

**1-09.2(7) Bid Item Descriptions for Measurement and Payment**

*Section 1-09.2(7) is added as follows:  
(Local Agency SP)*

The unit or lump sum Contract Prices shall constitute full payment for furnishing all labor, equipment, materials, permits and agreements, overhead and profit, and performing all operations required to complete the Work as defined in the Contract Documents. Notwithstanding the omission or mention of any incidental Work, the Contract Price and payment shall also constitute full compensation for all Work incidental to completion of item, unless such Work is otherwise specifically mentioned for separate payment under another Bid Item. Payment shall only be made for those items included in the Proposal and all Work required by the Contract shall be included in those Bid Items.

All measurements and computations shall be made by the Engineer or the Owner's Representative. The Contractor may perform quantity surveys for comparison at the Contractor's sole expense. If there is a discrepancy where the measured quantity cannot be agreed upon, the Engineer or Owner's Representative measurements shall be used.

Schedule A accounts for all improvements made between Pump Station 17 & the NE Tagholm Road/Brownsville Highway intersection, as well as the improvements at PS 17. Schedule B accounts for all improvements made between the NE Tagholm Road/Brownsville Highway intersection & the connection to the existing sewer system (completed during the emergency repair), as well as the improvements at PS 24. Schedule A accounts for approximately 75% of the total sewer force main being replaced. Schedule B accounts for approximately 25% of the total sewer force main being replaced. The bid items have been split into bid schedules accordingly.

Measurement and Payment shall be made in accordance with Section 1-04.6 for the following bid items:

Bid Items	Bid Item Name	Measurement/Payment Description
1A, 1B	Preconstruction Work Phase	The lump sum shall include work required during the Preconstruction Work Phase as described in Section 1-04.3(1) of the Special Provisions.
2A, 2B	Final Cleanup and Restoration	The lump sum shall include the daily and final cleanup and restoration of all paved and unpaved surfaces and areas disturbed by construction to conditions equal to, or better than existing.
3A, 3B	Surveying	The lump sum shall include all survey efforts required to locate and construct the improvements, perform settlement monitoring during excavation and dewatering activities, as well as as-built the completed work.
4A, 4B	Project Record Drawings	The lump sum shall include work associated with maintaining, updating, and modifying the Contract Drawings to reflect modifications in the completed work that differ from the design information shown on the Contract Drawings. Incremental payments, determined by dividing the calendar days in each pay period by the total calendar days under the contract and then multiplying by 60% of the lump sum amount, will be paid for each monthly update. No more than 60% of the total lump sum amount will be paid for monthly updates. The balance of the lump sum will be paid upon delivery and approval of acceptable record drawings by the Engineer near the end of physical construction. The lump sum for this bid item shall be at least 0.5% of the total bid amount.
5A, 5B	Type B Schedules	The unit price per month shall include all work associated with furnishing progress schedules, weekly look-ahead schedules, and schedule updates. Payment shall be made on a monthly basis for approved schedules. Progress payments will be contingent upon receipt and approval of the monthly schedule updates. Engineer has entered a minimum amount in the bid schedules for this bid item. Contractor's bid amount shall not be less than this amount. No payment shall be made for the draft or baseline construction schedules as these shall be considered incidental to the contract.

Bid Items	Bid Item Name	Measurement/Payment Description
6A, 6B	Minor Change (Allowance)*	This item is reserved as a construction contingency for "Minor Changes" which may occur during the course of the work. This budget allowance will facilitate minor additional work without the need for a Contract amendment. The Engineer will still prepare a work change directive and the Contractor will still prepare cost proposals for work that is agreed to be out of scope. The Contracting Agency's approval will be obtained prior to authorization of such work. See Section 1-09 for additional information.
7A, 7B	Mobilization and Demobilization	The lump sum shall include preconstruction expenses and the cost of preparatory work and operations performed by the Contractor, excluding work included in Bid Item 1, Preconstruction Work Phase. This work shall include, but not be limited to, the work identified in Section 1-09.7 of the Special Provisions. Mobilization and demobilization shall not exceed 10% of the total contract amount. Payment for mobilization and demobilization will be limited to 70% and 30%, respectively, of the total bid amount. Schedule A lump sum costs shall account for 70% of the Mobilization and Demobilization bid item. Schedule B lump sum costs shall account for 30% of Mobilization and Demobilization bid item.
8A, 8B	Dewatering (Allowance)*	This item is an allowance for dewatering for control of surface and groundwater, outside of trench dewatering. The actual cost of dewatering will be paid for in accordance with Section 1-09 and Section 31 23 43.
9A, 9B	Excavation Support Systems	The lump sum shall include all work required to comply with requirements of the Washington State Safety Code relating to excavation, trenching, and shoring: "Safety Standards for Construction Work", Chapter 296-155 WAC Part N. The unit price shall also include temporary sheeting, shoring and bracing or equivalent methods, including design and engineering fees associated thereof, as well as furnishing, constructing, removing, and disposing of temporary sheeting, shoring, and bracing. The unit price shall be full compensation for excavation, backfilling, compaction, and other work required when extra excavation is used in lieu of shoring. If select or imported backfill material is required for backfilling within the neat line trench limits excavation, it shall also be required as backfill material for the extra excavation and overbreak at the Contractor's expense.

Bid Items	Bid Item Name	Measurement/Payment Description
10A, 10B	Temporary Erosion and Sediment Control	The lump sum shall include preparing the temporary erosion and sediment control (TESC) plan and updating it when necessary as well as furnishing, installing, maintaining, and removing TESC measures, as shown on the Plans and specified in the Contract Documents.
11A, 11B	Project Temporary Traffic Control	The lump sum shall include the provision of temporary traffic control for the project as required for traffic safety and to minimize traffic disruptions and public inconvenience. This shall include but not be limited to labor, Uniformed Police Office (UPO), Portable Changeable Message Sign (PCMS), and the preparation and submittal of all Contractor traffic control plans as shown on the Plans and specified in the Contract Documents.
12A, 12B	Existing Infrastructure/Utility Conflicts (Allowance)*	This item is an allowance for existing infrastructure and utility conflicts unforeseen or unidentified on the Plans. The actual cost of addressing existing infrastructure/utility conflicts will be paid for in accordance with Section 1-09.
13A	24-inch Diameter HDPE DR 11 Sewer Force Main	Measurement for payment for pipe for sewer force mains shall be per lineal foot of pipe installed and tested, except piping included at connection details. Measurement shall be to the nearest foot along the pipe through fittings, valves, and couplings. The unit Contract price per linear foot of 24-inch HDPE DR 11 Sewer Force Main shall be full payment for Work to complete the installation of the 24-inch sewer force main, including but not limited to, pipe, fittings, valves, couplings, potholing for utility conflicts, excavating the trench, dewatering the trench, preparing the trench foundation, laying and joining pipe and fittings, supporting existing pipe crossings from above, where pipe installation occurs below existing utilities, furnishing pipe bedding, foundation material (where required), placing and compacting the bedding material and trench backfill, installing concrete thrust blocking, pigging, cleaning, and testing the pipeline. The unit price shall also include the cost of installing tracer wire and detectable marking tape, maintaining and restoring existing utilities impacted by construction, installing and removing temporary fencing required to isolate the construction zone from public access, and performing daily cleanup around the worksite.

Bid Items	Bid Item Name	Measurement/Payment Description
14A	Horizontal Directional Drilled 24-inch Diameter, HDPE DR 11 Force Main	Payment for all labor, materials and equipment required to install 24-inch Diameter HDPE DR 11 force main, along Clear Creek Road, using horizontal directional drilling, including tracer wires, testing, inspection and acceptance, handling, transport and storage of pipe, incidentals, and connections to the force main on each end, complete, as shown on the plans, will be on a lump sum basis.
15A	26-inch Diameter HDPE DR 11 Sewer Force Main	Measurement for payment for pipe for sewer force mains shall be per lineal foot of pipe installed and tested, except piping included at connection details. Measurement shall be to the nearest foot along the pipe through fittings, valves, and couplings. The unit Contract price per linear foot of 26-inch Diameter HDPE DR 11 Sewer Force Main shall be full payment for Work to complete the installation of the 26-inch sewer force main, including but not limited to, pipe, fittings, valves, couplings, potholing for utility conflicts, excavating the trench, dewatering the trench, preparing the trench foundation, laying and joining pipe and fittings, supporting existing pipe crossings from above, where pipe installation occurs below existing utilities, furnishing pipe bedding, foundation material (where required), placing and compacting the bedding material and trench backfill, installing concrete thrust blocking, pigging, cleaning, and testing the pipeline. The unit price shall also include the cost of installing tracer wire and detectable marking tape, maintaining and restoring existing utilities impacted by construction, installing and removing temporary fencing required to isolate the construction zone from public access, and performing daily cleanup around the worksite.

Bid Items	Bid Item Name	Measurement/Payment Description
13B	30-inch Diameter HDPE DR 11 Sewer Force Main	Measurement for payment for pipe for sewer force mains shall be per lineal foot of pipe installed and tested, except piping included at connection details. Measurement shall be to the nearest foot along the pipe through fittings, valves, and couplings. The unit Contract price per linear foot of 30-inch Diameter HDPE DR 11 Sewer Force Main shall be full payment for Work to complete the installation of the 30-inch sewer force main, including but not limited to, pipe, fittings, valves, couplings, potholing for utility conflicts, excavating the trench, dewatering the trench, preparing the trench foundation, laying and joining pipe and fittings, supporting existing pipe crossings from above, where pipe installation occurs below existing utilities, furnishing pipe bedding, foundation material (where required), placing and compacting the bedding material and trench backfill, installing concrete thrust blocking, pigging, cleaning, and testing the pipeline. The unit price shall also include the cost of installing tracer wire and detectable marking tape, maintaining and restoring existing utilities impacted by construction, installing and removing temporary fencing required to isolate the construction zone from public access, and performing daily cleanup around the worksite.
16A	60-inch Diameter Manhole (BPA Easement) and Bioswale	60-inch Diameter Manhole (BPA Easement) shall be measured per each regardless of depth of the manhole. Payment for 60-inch Diameter Manhole shall include all work associated with installing a 60-inch diameter manhole, including, but not limited to, excavation, dewatering, bedding, backfill and compaction around the new manhole, furnishing and installing the manhole base with required stub, barrel, grade rings, rungs and ladder, manhole frame and cover, channeling the manhole, final adjustment of structure to grade, interior and exterior coatings, and other incidental work and materials for a complete installation. Measurement and payment for each 60-inch Diameter Manhole will also include all work associated with installing a bioswale replacement unit including, but not limited to excavation, dewatering, bedding, backfill and compaction, concrete block retaining walls, odor control piping, odor control drums, media for the bioswale, and removal and disposal of the existing bioswale unit.

Bid Items	Bid Item Name	Measurement/Payment Description
17A	20-inch Diameter CIPP Sewer Force Main	The unit price for linear foot for 20-inch Diameter CIPP Sewer Force Main shall include furnishing, installing, and curing 20-inch CIPP, including all work, materials, and equipment needed for excavation for up to 6 feet of cover, all exploratory investigations, preliminary CCTV inspection, cleaning and surface preparation, and dewatering will be on a per linear foot basis for the 20-inch ductile iron pipe shown and to be without failure upon testing or subsequent failure within one-year warranty period. Measurement will be based on total length of piping constructed and cured as indicated on the plans.
18A, 14B	2-inch Combination Air Vacuum Valve Assembly	The unit price per each shall include all work to furnish and install the combination air/vacuum valves and vaults, including, but not limited to, required excavation and backfilling, connection to force main, piping, fittings, valves, valve boxes, supports, hoses, vault interior and exterior coatings, odorous air canisters, detectable marking tape, and tracer wire.
19A, 15B	3-inch Combination Air Vacuum Valve Assembly	The unit price per each shall include all work to furnish and install the combination air/vacuum valves and vaults, including, but not limited to, required excavation and backfilling, connection to force main, piping, fittings, valves, valve boxes, supports, hoses, vault interior and exterior coatings, odorous air canisters, detectable marking tape, and tracer wire.
20A, 16B	4-inch Blowoff Valve Assembly	The unit price per each shall include all work to furnish and install the blowoff assembly, including, but not limited to, required excavation and backfilling, connection to force main, piping, fittings, valves, valve boxes, precast concrete structures, manhole lid and frame, detectable marking tape, and tracer wire.
21A, 17B	IPS Sewer Lateral from ROW to Main	The unit price per each shall include all work, materials, tools, labor, and equipment necessary to install a new side sewer force main from the new force main to the ROW line. Each unit price includes, but is not limited to, excavation, bedding and backfill, pipe, fittings, valves, valve boxes and appurtenances, detectable marking tape, and tracer wire.
22A	26-inch Diameter HDPE DR 11 11.25 Degree Bend	The unit price per each shall include all work, materials, tool, labor, and equipment necessary to furnish and install bend including, but not limited to, required thrust blocks as shown on the Plans and specified in the Contract Documents.

23A	26-inch Diameter HDPE DR 11 22.5 Degree Bend	The unit price per each shall include all work, materials, tool, labor, and equipment necessary to furnish and install bend including, but not limited to, required thrust blocks as shown on the Plans and specified in the Contract Documents.
24A	24-inch Diameter HDPE DR 11 45 Degree Bend	The unit price per each shall include all work, materials, tool, labor, and equipment necessary to furnish and install bend including, but not limited to, required thrust blocks as shown on the Plans and specified in the Contract Documents.



Bid Items	Bid Item Name	Measurement/Payment Description
25A	26-inch Diameter HDPE DR 11 45 Degree Bend	The unit price per each shall include all work, materials, tool, labor, and equipment necessary to furnish and install bend including, but not limited to, required thrust blocks as shown on the Plans and specified in the Contract Documents.
18B	26-inch Diameter HDPE DR 11 45 Degree Bend	The unit price per each shall include all work, materials, tool, labor, and equipment necessary to furnish and install bend including, but not limited to, required thrust blocks as shown on the Plans and specified in the Contract Documents.
19B	30-inch Diameter HDPE DR 11 45 Degree Bend	The unit price per each shall include all work, materials, tool, labor, and equipment necessary to furnish and install bend including, but not limited to, required thrust blocks as shown on the Plans and specified in the Contract Documents.
26A	26-inch Diameter HDPE DR 11 Non-Standard Bend	The unit price per each shall include all work, materials, tool, labor, and equipment necessary to furnish and install bend including, but not limited to, required thrust blocks as shown on the Plans and specified in the Contract Documents.
27A	24-inch Diameter HDPE DR 11 Flange Adapter	The unit price per each pair shall include all work, materials, tool, labor, and equipment necessary to furnish and install pair of flange adapters including, but not limited to, associated hardware, gaskets, bolts, backing rings, and nuts.
28A, 20B	26-inch Diameter HDPE DR 11 Flange Adapter	The unit price per each pair shall include all work, materials, tool, labor, and equipment necessary to furnish and install pair of flange adapters including, but not limited to, associated hardware, gaskets, bolts, backing rings, and nuts.
21B	30-inch Diameter HDPE DR 11 Flange Adapter	The unit price per each pair shall include all work, materials, tool, labor, and equipment necessary to furnish and install pair of flange adapters including, but not limited to, associated hardware, gaskets, bolts, backing rings, and nuts.
29A, 22B	Abandon Existing Force Main	The unit price per linear foot shall include all work materials, tools, labor, and equipment necessary to abandon the existing 18-inch, 20-inch and 24-inch Ductile Iron sewer force main including, but not limited to, capping pipes, temporary venting, and filling existing pipe with CDF as shown on the Plans and specified in the Contract Documents.

Bid Items	Bid Item Name	Measurement/Payment Description
30A	Pump Station 17 Improvements, Bypass, and Final Connections	The lump sum shall include full compensation for work, materials, tools, labor and equipment necessary to complete the Pump Station 17 site improvements, bypass and final connections as shown on the Plans and specified in the Contract Documents. The Pump Station 17 site is defined as the portion of the overall project area of work north of the proposed sewer force main and west of the new sewer force main as shown on the Plans and specified in the Contract Documents. The work includes, but is not limited to haul, excavation, disposal of excess or waste material, removal and disposal of existing asphalt surfacing, bedding, backfill, compaction, removal and abandonment of existing force main, relocation of existing pig launch, vault and valves, installation of new flow meter vault, flow meter and appurtenances, connecting flow meter to existing PLC and telemetry systems, testing, new chain link fence, gate, installation, operation and removal of temporary sewage bypass system, connection to existing Pump Station 17.
23B	Pump Station 24 Improvements, Bypass, and Final Connections	The lump sum shall include full compensation for work, materials, tools, labor, and equipment necessary to complete the Pump Station 24 bypass, site improvements and final connections as shown on the Plans and specified in the Contract Documents. The work includes, but is not limited to, haul, excavation, disposal of excess or waste material, removal and disposal of existing asphalt surfacing, bedding, backfill, compaction, installation of the 96" precast manhole, interior and exterior coating of 96" manhole, installation of 24" ductile iron pipe from the 96" manhole to the existing wet well, connection to the existing wet well, removal and replacement of the existing 24" flow meter including electrical and control system integration, installation of a complete wet well flushing system including all ductile iron piping and appurtenances, upgrades to the existing pig launch vault and installation of ductile iron pipe, fittings and valves from the existing pig launch vault to the HDPE force main as shown in the Plans and specified in the Contract Documents, installation of ductile iron pipe, fittings and valves on the HDPE force main as shown in the Plans and specified in the Contract Documents, removal and abandonment of existing force main and pig launch piping and fittings, cleaning, testing, preparation and installation of Raven 405 coating of the existing wetwell interior floor, walls, roof, and interior piping and appurtenances, installation and operation of bypass pumps, temporary control system, temporary piping and appurtenances.

Bid Items	Bid Item Name	Measurement/Payment Description
31A,24B	Brownsville Hwy Connection	The lump sum shall include full compensation for work, materials, tools, labor and equipment necessary to complete the connections from the new Tagholm Road isolation valve and existing Pump Station 67 force main to the 30" HDPE force main on Brownsville Hwy as shown on the Plans and specified in the Contract Documents. The work includes, but is not limited to, haul, excavation, disposal of excess or waste material, bedding, backfill, compaction, installation of all 24-inch, 26-inch, and 30-inch ductile iron and HDPE piping, adaptors, reducers, valves, fittings and appurtenances, potholing, and removal of existing ductile iron force mains.
32A	CIPP Bypass	The lump sum shall include full compensation for work, materials, tools, labor and equipment necessary to complete bypassing during CIPP operations. The work includes, but is not limited to, installation, operation, maintenance and removal of temporary bypass piping, fittings, valves, traffic control measures, verification of existing conditions, clearing, blocking, pressure testing, blowoffs and other items as required for a complete bypass system.
25B	Connect to Existing 30-inch Diameter HDPE DR 11 Force Main	The lump sum shall include full compensation for work, labor, materials, and equipment necessary to connect to the existing 30-inch Diameter HDPE DR 11 force main as shown on the Plans and specified in the Contract Documents. The work includes, but is not limited to, excavation, disposal of excess or waste material, bedding, backfill, compaction, verification of existing conditions, installation of temporary blowoffs, removal of existing force main piping and fittings, connection of new 30-inch HDPE force main to existing force main, installation of new blind flange on existing 30-inch HDPE force main, capping of existing C900 force main, and temporary bypass if required.
33A	Connect to Existing Pump Station 64	The lump sum shall include full compensation for work, labor, materials, and equipment necessary to connect to the existing Pump Station 64 force main isolation valve as shown on the Plans and specified in the Contract Documents. The work includes, but is not limited to, haul, excavation, disposal of excess or waste material, bedding, backfill, compaction, verification of existing conditions, installation of 3-inch HDPE pipe, fittings and appurtenances, and testing.

Bid Items	Bid Item Name	Measurement/Payment Description
34A	CIPP Connection to New Saddle Manhole	Measurement and payment for cured-in-place pipe (CIPP) end connections shall be made on a per each basis. The unit price shall be full payment for furnishing all labor, materials, and equipment necessary to connect to the existing 20-inch ductile iron force main to the new Saddle Manhole as shown in the Plans and specified in the Contract Documents. The work includes, but is not limited to, including haul, excavation, disposal of excess or waste material, bedding, backfill, compaction, installation of sewer force main ductile iron pipe, fittings, and appurtenances. Work will also include verification of existing conditions, temporary blocking installation and removal, pressure testing, capping, temporary blowoffs and other items required for testing.
35A	CIPP Connection to New 26-inch Diameter HDPE DR 11 Pipe	Measurement and payment for cured-in-place pipe (CIPP) end connections shall be made on a per each basis. The unit price shall be full payment for furnishing all labor, materials, and equipment necessary to connect to the existing 20-inch ductile iron force main to the new 26-inch HDPE force main as shown in the Plans and specified in the Contract Documents. The work includes, but is not limited to, including haul, excavation, disposal of excess or waste material, bedding, backfill, compaction, installation of sewer force main ductile iron pipe, fittings, and appurtenances. Work will also include verification of existing conditions, temporary blocking installation and removal, pressure testing, capping, temporary blowoffs and other items required for testing.
36A, 26B	Asphalt Removal	The unit price per square yard shall include work, materials, tools, labor, and equipment necessary for removal and disposal of as shown on the Plans and specified in the Contract Documents.
37A, 27B	Removal of Unsuitable Foundation Material (Allowance)*	The unit price per cubic yard shall include work, materials, tools, labor and equipment necessary for removal and disposal of unsuitable foundation material as defined by the Engineer. For the purpose of establishing a common basis for evaluating bids, a provisional quantity has been shown on the bid form and does not necessarily represent the quantity, if any, that may be necessary for project work.

<p>38A, 28B</p>	<p>Import Trench Foundation Material (Allowance)*</p>	<p>The unit price per ton shall include work, materials, tools, labor and equipment associated with furnishing, placing and compacting import trench foundation material where unsuitable foundation materials are encountered, or as directed by the Engineer. The unit price shall also include all costs associated with furnishing and installing geosynthetic fabric where necessary to stabilize soils as directed by the Engineer. Certified weight tickets must be received by the Engineer at the delivery site for each load in accordance with Section 1-09. For the purpose of establishing a common basis for evaluating bids, a provisional quantity has been shown on the bid form and does not necessarily represent the quantity, if any, that may be necessary for project work.</p>
-----------------	-------------------------------------------------------	--------------------------------------------------------------------------------------------------------------------------------------------------------------------------------------------------------------------------------------------------------------------------------------------------------------------------------------------------------------------------------------------------------------------------------------------------------------------------------------------------------------------------------------------------------------------------------------------------------------------------------------------------------------------------------------------------------------------------------------------------------------------------------------------------------

Bid Items	Bid Item Name	Measurement/Payment Description
39A, 29B	Trench Backfill	The unit price per ton for Backfill, shall include hauling and furnishing the imported material and hauling and disposing of the unsuitable native material replaced by this trench backfill as shown on the Plans and specified in the Contract Documents. Installation and compaction of the backfill shall be included in the cost of the pipe and shall include all costs associated furnishing the material and all costs associated with the over-excavation and disposal of the surplus and unsuitable trench excavation replaced by this backfilling. The unit price per ton shall include all work, materials, tools, labor, and equipment necessary for backfilling. The amount of Backfill in Schedule A and B is determined by the amount of pipe shown on the drawings.
40A	Controlled Density Fill (CDF) Encasement	The unit price per cubic shall include furnishing and installing CDF for encasement of pipes and utility crossings as shown on the Plans and specified in the Contract Documents. This bid item shall also include hauling and disposing of the material being replaced by the CDF. CDF used as pipe bedding shall be incidental to the cost of the pipe and shall not be paid under this bid item.
41A, 30B	Crushed Surfacing Base Course (CSBC)	The unit price per ton shall include hauling, furnishing, placing, and compacting crushed surfacing base course (CSBC) as shown on the Plans and specified in the Contract Documents. The unit price shall also include the removal and proper disposal of material being replaced by the crushed surfacing base course. No additional or separate payment shall be made for sub-grade preparation.
42A, 31B	Crushed Surfacing Top Course (CSTC)	The unit price per ton shall include hauling, furnishing, placing, and compacting crushed surfacing top course (CSTC) as shown on the Plans and specified in the Contract Documents. The unit price shall also include the removal and proper disposal of material being replaced by the crushed surfacing base course. No additional or separate payment shall be made for sub-grade preparation.

Bid Items	Bid Item Name	Measurement/Payment Description
43A, 32B	HMA Cl. ½-inch PG 58-22 for Trench Patch	<p>The unit price per ton shall include all work, materials, tools, labor, and equipment required for installation of temporary and permanent HMA as shown on the Plans and specified in the Contract Documents. The unit price shall also include sawcutting existing asphalt, removal and proper disposal of subgrade and all existing asphalt being replaced by the new asphalt, preparing the subgrade for paving; cleaning of existing asphalt; joint sealing; grinding at transitions; placing tack coat; furnishing, hauling, placing, and compacting the temporary and permanent HMA pavement; adjusting all utility covers and monument case covers to the new grade as necessary; replacing all disturbed pavement striping and markings; and all other incidental work to complete the HMA pavement. No pay factors will be used for temporary or permanent HMA pavement. The Contractor is hereby advised that existing asphalt pavement varies by depth and material and no additional compensation shall be made for these variances. The unit price per ton shall include all work, materials, tools, labor, and equipment required for installation of temporary and permanent HMA trench patch, as shown on the Plans, including but not limited to, subgrade preparation, cleaning of existing asphalt, joint sealing, placing tack coat, furnishing, hauling, placing, and compacting the temporary and permanent HMA pavement, adjusting utility covers and monument case covers to the new grade as necessary, and replacing disturbed pavement striping and markings. The amount of HMA Cl. ½ PG 58-22 in Schedule A and B is determined by the amount of pipe shown on the drawings.</p>

Bid Items	Bid Item Name	Measurement/Payment Description
44A, 33B	HMA Cl. ½-inch PG 58-22 Extended	<p>The unit price per ton shall include all work, materials, tools, labor, and equipment required for installation of permanent HMA as shown on the Plans and specified in the Contract Documents. The unit price shall also include sawcutting existing asphalt, removal and proper disposal of subgrade and all existing asphalt being replaced by the new asphalt, preparing the sub-grade for paving; cleaning of existing asphalt; joint sealing; grinding at transitions; placing tack coat; furnishing, hauling, placing, and compacting the permanent HMA pavement; adjusting all utility covers and monument case covers to the new grade as necessary; replacing all disturbed pavement striping and markings; and all other incidental work to complete the HMA pavement. No pay factors will be used for temporary or permanent HMA pavement. The Contractor is hereby advised that existing asphalt pavement varies by depth and material and no additional compensation shall be made for these variances. The unit price per ton shall include all work, materials, tools, labor, and equipment required for installation of permanent HMA pavement extended past the trench patch as shown on the Plans, including but not limited to, subgrade preparation, cleaning of existing asphalt, joint sealing, placing tack coat, furnishing, hauling, placing, and compacting the permanent HMA pavement, adjusting utility covers and monument case covers to the new grade as necessary, and replacing disturbed pavement striping and markings. The amount of HMA Cl. ½ PG 58-22 Extended in Schedule A and B is determined by the amount of pipe shown on the drawings.</p>
45A, 34B	General Restoration	<p>The unit price per square foot shall include all work, materials, tools, labor, and equipment required for installation of hydroseeding, soils and other appurtenances to restore existing natural landscape as shown on the Plans and specified in the Contract Documents.as shown on the Plans. The amount of General Restoration in Schedule A and B is determined by the amount of pipe shown on the drawings.</p>



Bid Items	Bid Item Name	Measurement/Payment Description
46A	ROW Restoration at NW Katy Place and NE Tagholm Rd	The lump sum shall include all work, materials, tools, labor and equipment required to restore right-of-way to conditions equal to, or better than existing where the proposed sewer force main work disrupts existing improvements within the ROW outside of roadway on NW Katy Place and NE Tagholm Road as shown on the Plans and specified in the Contract Documents. Work includes but is not limited to restoration and/or replacement of existing fencing (wood, concrete and chain-link), existing wrought iron gates, rockery/rock and retaining walls, existing trees and landscape plantings, existing lawns, concrete and HMA driveways, and relocation of existing sheds. Lump sum price shall also include removal, replacement, reinstallation and protection of both identified and unidentified existing trees, power poles, mailboxes, drain lines, irrigation/sprinkler lines etc.
47A	Grass Pavers	The unit price per square yard shall include all work, materials, tools, labor, and equipment required for installation of interlocking plastic pavers, topsoil, hydroseeding, CSBC, gravel borrow geotextile fabric, and preparation and compaction of subgrade as shown on the Plans and specified in the Contract Documents.
48A, 35B	Replace Survey Monument (Allowance)*	The unit price per each shall include all work, materials, tools, labor, and equipment including the removal and restoration of an existing disturbed monument to its proper location as required. The work includes, but is not limited to, securing the necessary permit(s), surveying, excavation, foundation, monument base, monument case and cover, monument, backfilling, and surface restoration, and any other items necessary to accomplish the work. For the purpose of establishing a common basis for evaluating bids, a provisional quantity has been shown on the bid form and does not necessarily represent the quantity, if any, that may be necessary for project work.

\* Allowance - For the purpose of establishing a common basis for evaluating bids, an arbitrary quantity and/or bid amount for this item has been shown on the bid form and does not necessarily represent the quantity and/or cost that may be necessary for the work. The Variation in Estimated Quantities provisions of Section 1-04.6 of the Standard Specifications shall not apply to this item. Quantities and/or payments will be determined in the field as work progresses.

**1-09.6 Force Account**

*Section 1-09.6 is supplemented with the following:  
(Local Agency SP)*

The Contracting Agency has estimated and included in the Proposal, a dollar amount for Bid Items "Minor Changes (Allowance)", "Dewatering (Allowance)", "Existing Infrastructure/Utility Conflicts (Allowance)", "Removal of Unsuitable Foundation Material (Allowance)", and "Import Trench Foundation Material (Allowance)" (also referenced as Force Account), only to provide a common proposal for Bidders. This dollar amount shall become a part of Contractor's total bid. However, the Contracting Agency does not warrant expressly or by implication that the actual amount of work will correspond with the estimate. Payment will be made on the basis of the amount of work actually authorized by Engineer through Work Directives.

A complete list including name, labor classification and weighted wage rate of all personnel to be performing "Force Main" work shall be given to the Engineer before "Force Main" work starts. A list including all pertinent information, such as equipment name and model, year, engine size, bucket size, capacity, etc., for all equipment to be used for performance of "Force Main" work shall also be furnished to the Engineer prior to beginning "Force Main" work.

**1-09.7 Mobilization**

*The second and third paragraphs and the associated subparagraphs of Section 1-09.7 are deleted and replaced with the following:  
(Local Agency SP)*

"Mobilization and Demobilization" shall include but not be limited to the following items:

1. Movement of Contractor's personnel, equipment, supplies, and incidentals to the project site;
2. The establishment of onsite trailer, including procurement of all utilities to serve the offices such as power, telephone, fax, high speed internet, etc.;
3. Securing suitable storage area(s), staging area(s), parking area(s) and other facilities necessary for work on the project;
4. Providing sanitary facilities for Contractor and Contracting Agency personnel;
5. Securing private agreements for temporary land use on adjacent properties as needed and providing a copy of all such agreements to the Engineer as required by Section 1-07.24;
6. All other pre-construction expenses and costs for preparatory work and operations performed by the Contractor; and
7. All demobilization costs, including removal of equipment, excess materials, trailer and general cleanup.

**1-09.9 Payments**

*Delete the first four paragraphs of Section 1-09.9 and replace them with the following:  
(March 13, 2012 APWA GSP)*

The basis of payment will be the actual quantities of Work performed according to the Contract and as specified for payment.

The Contractor shall submit a breakdown of the cost of lump sum bid items at the Preconstruction Conference, to enable the Project Engineer to determine the Work performed on a monthly basis. A breakdown is not required for lump sum items that include a basis for incremental payments as part of the respective Specification. Absent a lump sum breakdown, the Project Engineer will make a determination based on information available. The Project Engineer's determination of the cost of work shall be final.

Progress payments for completed work and material on hand will be based upon progress estimates prepared by the Engineer. A progress estimate cutoff date will be established at the preconstruction conference.

The initial progress estimate will be made not later than 30 days after the Contractor commences the work, and successive progress estimates will be made every month thereafter until the Completion Date. Progress estimates made during progress of the work are tentative, and made only for the purpose of determining progress payments. The progress estimates are subject to change at any time prior to the calculation of the final payment.

The value of the progress estimate will be the sum of the following:

1. Unit Price Items in the Bid Form — the approximate quantity of acceptable units of work completed multiplied by the unit price.
2. Lump Sum Items in the Bid Form — based on the approved Contractor's lump sum breakdown for that item, or absent such a breakdown, based on the Engineer's determination.
3. Materials on Hand — 100 percent of invoiced cost of material delivered to Job site or other storage area approved by the Engineer.
4. Change Orders — entitlement for approved extra cost or completed extra work as determined by the Engineer.

Progress payments will be made in accordance with the progress estimate less:

1. Retainage per Section 1-09.9(1);
2. The amount of Progress Payments previously made; and
3. Funds withheld by the Contracting Agency for disbursement in accordance with the Contract Documents.

Progress payments for work performed shall not be evidence of acceptable performance or an admission by the Contracting Agency that any work has been satisfactorily completed. The determination of payments under the contract will be final in accordance with Section 1-05.1.

#### **1-09.9(2) Contracting Agency's Right to Withhold and Disburse Monies Due**

*Section 1-09.9(2) is added as the following:  
(Local Agency SP)*

In addition to monies retained pursuant to RCW 60.28 and subject to RCW 39.04.250, RCW 39.12, and RCW 39.76, the Contractor authorizes the Engineer to withhold progress payments due or deduct an amount from any payment or payments due the Contractor which, in the Engineer's opinion, may be necessary to cover the Contracting Agency's costs for or to remedy the following situations:

1. Work not in accordance with the Contract Documents;
2. Defective work or equipment cost or liability that may occur to Contracting Agency as a result of Contractor's, Subcontractors or Suppliers failure to perform;
3. Damage to another contractor when there is evidence thereof and a claim has been filed;
4. Where the Contractor has not paid fees or charges to public authorities or municipalities which the Contractor is obligated to pay;
5. Utilizing material, tested and inspected by the Engineer, for purposes not connected with the Work (See Section 1-05.6);
6. Landscape damage assessments (See Section 1-07.16);
7. For overtime work performed by the Engineer or Contracting Agency personnel (See Section 1-08.0(3)).

8. Liquidated damages associated with exceeding the Contract Time (See Section 1-08.9 Liquidated Damage); or
9. Failure of the Contractor to perform any of the Contractor's other obligations under the contract, including but not limited to:
  - a. Failure of the Contractor to protect survey stakes, markers, etc., or to provide adequate survey work as required by Section 1-05.4.
  - b. Failure of the Contractor to correct defective or unauthorized equipment or work (Section 1-05.7).
  - c. Failure of the Contractor to furnish a Manufacturer's Certificate of Compliance in lieu of material testing and inspection as required by Section 1-06.3.
  - d. Failure to submit Intent to Pay Prevailing Wage forms, or correct underpayment to employees of the Contractor or subcontractor of any tier as required by Section 1-07.9.
  - e. Failure of the Contractor to pay worker's benefits (Title 50 and Title 51 RCW) as required by Section 1-07.10.
  - f. Failure of the Contractor to submit and obtain acceptance of a progress schedule per Section 1-08.3.

Lack of construction progress based upon the Engineer's review of the Contractor's approved progress schedule which indicates the Work will not be completed within the Contract Time may also be a basis for withholding progress payments due or to deduct an amount from any payment or payments due the Contractor. The amount withheld under this subparagraph will be based upon the liquidated damages amount per day set forth in Contract Documents multiplied by the number of calendar days the Contractor's approved progress schedule, in the opinion of the Engineer, indicates the Contract may exceed the Contract Time.

The Contractor authorizes the Contracting Agency to act as agent for the Contractor disbursing such funds as have been withheld pursuant to this section to a party or parties who are entitled to payment. Disbursement of such funds, if the Contracting Agency elects to do so, will be made only after giving the Contractor fifteen (15) calendar days prior written notice of the Contracting Agency's intent to do so, and if prior to the expiration of the 15-calendar day period, no legal action has commenced to resolve the validity of the claims, and the Contractor has not protested such disbursement.

A proper accounting of all funds disbursed on behalf of the Contractor in accordance with this section will be made. A payment made pursuant to this section shall be considered as payment under the terms and conditions of the Contract. The Contracting Agency shall not be liable to the Contractor for such payment made in good faith.

If legal action is instituted to determine the validity of the claims prior to expiration of the 15-day period mentioned above, the Engineer will hold the funds until determination of the action or written settlement agreement of the parties.

#### **1-09.11(1) Disputes Review Board**

*Delete Sections 1-09.11(1,) 1-09.11(1)A, and 1-09.11(1)B and replace with the following:  
(Local Agency SP)*

The formation and use of a dispute resolution board is not included in this Contract.

#### **1-09.13(3)A Administration of Arbitration**

*Revise the third paragraph to read:  
(November 30, 2018 APWA GSP)*

The Contracting Agency and the Contractor mutually agree to be bound by the decision of the arbitrator, and judgment upon the award rendered by the arbitrator may be entered in the Superior Court of the

county in which the Contracting Agency's headquarters is located, provided that where claims subject to arbitration are asserted against a county, RCW 36.01.050 shall control venue and jurisdiction of the Superior Court. The decision of the arbitrator and the specific basis for the decision shall be in writing. The arbitrator shall use the Contract as a basis for decisions.

**END OF SECTION 1-09**

THIS PAGE INTENTIONALLY LEFT BLANK

**1-10 Temporary Traffic Control****1-10.2(1) General**

*Section 1-10.2(1) is supplemented with the following:  
(Local Agency SP)*

The primary and alternate TCS shall be certified by one of the following:

1. The Northwest Laborers-Employers Training Trust  
27055 Ohio Avenue  
Kingston, WA 98346  
(360) 297-3035
2. Evergreen Safety Council  
401 Pontius Avenue North  
Seattle, WA 98109  
(206) 382-4090 or  
1-800-521-0778

**1-10.2(1)A Traffic Control Management**

*The fifth item of the first paragraph of Section 1-10.2(1)A is revised to read as follows:  
(Local Agency SP)*

1. Coordinating the project's activities (such as ramp closures, road closures and lane closures) with appropriate police, fire control agencies, city or county engineering, medical emergency agencies, school districts, and transit companies at least ten (10) working days prior to beginning the work.

**1-10.2(2) Traffic Control Plans**

*Supplement Section 1-10.2(2) with the following:  
(Local Agency SP)*

As a minimum, the Contractor's traffic control plan(s) shall include:

1. Drawings showing vehicular, bicycle, and pedestrian routing during each phase of the work, including permanent and temporary routing of traffic on all roadways.
2. Drawings showing the location of barricades, lighting, signing, and any other vehicular, bicycle, and pedestrian traffic control devices anticipated to be used during each phase of the work.
3. Anticipated traffic blockages resulting from construction activities.
4. Anticipated locations where temporary pipes, cables, or hoses will be placed across or parallel to roadways. Drawing details of ramps over utilities or shallow burial placement and protection cover shall be included.
5. Projected volumes of truck traffic over designated truck haul routes.

**1-10.3(2)F Public Convenience and Safety**

*Section 1-10.3(2)F is added as the following:  
(Local Agency SP)*

The Contractor shall conduct all operations with the least possible obstruction and inconvenience to the local public. The Contractor shall have under construction no greater amount of work than can be prosecuted properly with due regards to the rights of the public. To the extent possible, the Contractor shall finish each section before beginning work on the next.

To disrupt local access traffic as little as possible, the Contractor shall:

1. Permit local access traffic to pass by the work zone with the least possible inconvenience or delay.
2. Maintain existing roads and streets that lie next to or inside the project limits, keeping them open and in good, safe condition at all times.
3. Remove or repair any condition resulting from the work that might impede traffic or create a hazard, and
4. Keep existing traffic signal and highway lighting systems in operation as the work proceeds. (The Contracting Agency will continue the routine maintenance on such systems).
5. Provide provisions for access by buses and emergency vehicles to streets adjacent to the work zone.

To protect the rights of abutting property owners, the Contractor shall:

1. Conduct the construction so that the least inconvenience as possible is caused to abutting property owners.
2. Maintain ready access to driveways, houses, buildings, and mailboxes along the line of work. Should it be necessary to close an individual driveway for purposes of construction, the Contractor shall present an access plan to limit the driveway closure to less than 24-hours, unless otherwise indicated on the Drawings. Within 48-hours of the construction impeding the driveway, a drivable gravel surface shall be placed and compacted.
3. Provide ready access to pump stations and treatment facilities for operation and maintenance by Kitsap County.
4. Provide temporary approaches to crossing or intersecting roads and keep these approaches in good condition, and
5. Provide another access before closing an existing one whenever the Contract calls for removing and replacing an abutting owner's access.

The Contractor shall be responsible for providing adequate safeguards, safety devices, protective equipment, and any other needed actions to protect property in connection with the performance of the work covered by the Contract. The Contractor shall perform any measures or actions the Engineer may deem necessary to protect the public and property. The responsibility and expense to provide this protection shall be the Contractor's except that which is to be furnished by the Contracting Agency as specified in other sections of the Specifications.

Emergency traffic such as police, fire, and disaster units shall be provided access through the work site and to public and private properties at all times. The Contractor shall coordinate and perform all work in accordance with the requirements of police, fire, and other emergency services agencies.

The Contractor shall coordinate and perform all work in accordance with the requirements of all public transit and school bus service which may be operating in the project area. Safe and convenient access to the bus zones shall be provided and maintained at all times by the Contractor. The Contractor shall be liable for any damages which may result from failure to provide reasonable access or coordination.

The Contractor shall perform the work and provide access to enable solid waste pickup by solid waste collection firms at their regularly scheduled times. Contractor shall also provide access to mailboxes to enable Postal Service pickup and delivery at their regularly scheduled times.

### **1-10.3(2)G Construction and Maintenance of Detours**

*Section 1-10.3(2)G is added as the following:  
(Local Agency SP)*

Streets shall be closed to traffic only upon specific approval of the jurisdictional agency. Prior to the closure of any streets or roads, the Contractor shall prepare a written plan for detouring of traffic and shall



submit such plan to the jurisdictional agency for acceptance. Details shall be in accordance with the requirements of the latest edition of the Manual on Uniform Traffic Control Devices for Streets and Highways and such additional requirements as may be imposed by the Contracting Agency or other jurisdictional agency. Contractor is hereby informed that proposed road closures greater than 12 hours require approval by the County Council, which may take 4 to 6 weeks to process and will require specific time frames for the proposed closures. Contractor shall submit his/her traffic control plan as an early submittal at the Preconstruction Conference.

All detours, both inside and outside of the work area as required by the Contractor's operations, shall be the sole responsibility of the contractor. The design, construction and maintenance of detours and all temporary facilities required for detours shall be the sole responsibility of the Contractor.

**END SECTION 1-10**

THIS PAGE INTENTIONALLY LEFT BLANK

**1-11 Operations and Maintenance Data**

Section 1-11 and its subsections are added as the following:  
(Local Agency SP)

**1-11.1 Schedule of O&M Data Required**

The Contractor shall arrange for, and pay all costs associated with the services of the manufacturer's representative and/or others to provide and prepare operation and maintenance data for the system and/or equipment listed below:

1. Flow meters.
2. Valves.
3. Other systems or equipment that may need maintenance.

**1-11.2 Initial Submittal**

The Contractor shall submit a draft bookmarked and searchable PDF copy of the Operations and Maintenance Manual to the Engineer for review. The PDF shall comply with Section 1-06.1(3). The initial submittal shall be received by the Engineer at least twenty (20) Working Days prior to placement of the system and/or equipment in operation. The initial submittal may be delivered in multiple parts to the Engineer.

All information shall be specifically for the installed components. Data sheets which cover multiple equipment or list options shall be marked to indicate the installed equipment, including provided options. All other equipment or options shall be crossed out. Each item in the submittal shall include, but not be limited to the following information:

1. Fly sheet indicating: Contracting Agency's name; description of equipment; manufacturer's name, address, and telephone number; and local supplier/representative's name, address, and telephone number.
2. Detailed index indicating submittal contents, with major headings related to tabbed dividers.
3. Assembly drawings.
4. Parts list and/or bill of materials.
5. Wiring diagrams.
6. Lubrication instructions, including type and frequency.
7. Preventative and periodic maintenance summary.
8. Operating instructions.
9. Overhaul and parts replacement instructions.
10. Source for parts.
11. Testing and troubleshooting procedures.
12. Performance curves.
13. Factory and field test data.
14. List of recommended spare parts.
15. List of expendable parts (i.e., air or oil filters).
16. Warranty.

The Engineer will review the initial submittal and return it to the Contractor for incorporation of review comments.

**1-11.3 Final Submittal**

After the Contractor has addressed the Engineer's comments on the initial submittals, the Contractor shall assemble all components into an integrated document. The final submittal shall include two final tab divided hard copies and one bookmarked and searchable PDF copy that reflects the corrections. Each hard copy shall be bound in vinyl covered, three-ring binders. The integrated document shall consist of as many volumes as necessary to contain the data. Individual binders for each component of the submittal are not required. The binder shall be organized in a consistent format with tabbed dividers for each item. Each volume shall include, but not be limited to, the following:

1. The front cover and binding edge shall have typed labels identifying the project, Contracting Agency, and volume number;
2. Detailed index indicating the contents of the volume by major headings; and
3. Oversize (larger than 11"x17") prints shall be inserted in bound-in Kraft or Kevlar envelopes, placed at the end of the applicable area or subarea.

The integrated document shall be submitted to the Engineer within ten (10) Working Days after Substantial Completion of the work. If the integrated document does not meet the requirements of this Section, the Engineer may return the copy to the Contractor for corrections. The submittal process shall be repeated until the integrated document is acceptable. The Contractor shall anticipate that Final Acceptance may be delayed by the Contracting Agency if the integrated document is not acceptable to the Engineer.

**END OF SECTION 1-11**

**1-12 Internet-Based Project Management Requirements**

Section 1-12 and its subsections are added as the following:  
(Local Agency SP)

**1-12.1 Summary**

This Section specifies an Internet-based project management system, EADOC, required for use by the Contractor and the Owner for collaboration and communications of all Contract related work.

**1.12.2 Submittals**

Submit the following for each proposed authorized EADOC user within ten days of the effective date of the Notice to Proceed:

1. Name, title and company affiliation.
2. Address, phone number, email address and fax number.
3. Specific job related functions.
4. Level of authority within the Contractor's organization.
5. Level of permissions access requested for each user for accessing each EADOC module.

Submit an updated list of authorized users on a quarterly basis or more frequently as needed, to indicate users to be added or removed.

**1.12.3 Project Communications**

All official Project Communication and collaboration will take place in EADOC by creating and distributing documents directly within the system, or by scanning and/or uploading project documents into the system for distribution. Unless otherwise indicated, no other form of written Project Communication will be recognized.

Create submittals in EADOC's submittal module. Distribute reports, documents, samples, etc. that cannot be processed through EADOC per Section 1-06. Use EADOC to track and expedite processing submittals. Scan and/or upload support documentation into EADOC and attach to the main submittal document.

The Construction Manager or Engineer will respond to all documents using the appropriate EADOC module. All documents requiring formal signatures will be printed out in EADOC and hard copies signed and distributed. Otherwise, documents distributed electronically via EADOC will be considered official documentation. Documents requiring formal signature include:

1. Change Orders.
2. Construction Change Directives.
3. Pay applications.
4. All correspondence from the Contractor constituting any notification, which shall be submitted in accordance Section 1-05.15.
5. Others as determined by Owner

All documents will be electronically submitted to the Owner as an attachment to a transmittal created in EADOC transmittal module.

This Section shall not relieve the Contractor of its obligations to provide the Owner with Record Drawings in the physical form specified in Section 1-05.5.

**1.12.4 Access Requirements**

Contractor shall maintain the list of authorized users to reflect current authorized users of EADOC.

Contractor shall protect the security of the EADOC system by limiting access to authorized users only. Do not allow 'sharing' of usernames. Take appropriate precautions to maintain the security of the system. Ensure that Owner is notified immediately of any user who is no longer authorized to use the system so that their user account can be de-activated by the EADOC Administrator.

Access will only be permitted to certain modules, in accordance with permission levels configured by the EADOC Administrator. Requests to change permission levels must be submitted to the Construction Manager.

#### **1.12.5 Use Requirements**

EADOC shall be used as the Project file storage system with a file folder structure created by the Owner to organize the Project documents.

The use of EADOC is intended to expedite and improve collaboration and written contract communication and to accurately record the flow of Contract documentation.

Contractor shall encourage its major subcontractors to utilize the Internet-based project management system, as appropriate, to improve communications and coordination within the Contractor's team.

Contractor shall abide by all policies, procedures, and standards established by the Owner for the use and application of EADOC.

Contractor shall comply with applicable laws and regulations regarding electronic transmission of documents requiring professional engineering stamps or signatures, including provision of hard copies of such documents as appropriate.

Project Communications that require the signature of authorized persons will use either:

1. An approved "image" of the official signature affixed to the document. Also provide Owner with the original signed hard copy/paper document.
2. An electronic copy or electronic image of a fully executed document containing the required signatures. Also provide Owner with the original signed hard copy/paper document.

#### **1.12.6 Downtime**

In the event that the EADOC system is temporarily unavailable, continue with Project Communications utilizing other electronic means (email) or hard copies to transmit and receive Project Communications.

Maintain records of all Project Communication during the EADOC downtime and upload the records to EADOC when it is operational.

Notify the Owner's EADOC Administrator by telephone or email when EADOC is not functional.

#### **1.12.7 EADOC Training**

Submit a proposed schedule of attendance for the EADOC training sessions including a list of back up personnel. EADOC training is mandatory for listed users of EADOC prior to use, including any training sessions scheduled by the Owner. Contractor shall provide for up to 12 hours of EADOC training for up to 3 staff. The Contractor is not required to pay EADOC for the training sessions, but shall pay for the required Contractor staff to attend the training.

#### **1.12.8 Project Management System Requirements**

Provide computer hardware and software that meet the requirements of the EADOC project management software at both field office and home office location(s) where Project Communications on this Contract are generated or processed.

##### **1.12.8(1) Modifications**

EADOC is continually modified and improved in order to enhance the product and provide additional functionality. EADOC has many methods of alerting clients to changes and providing support to the end users.

**1-12.8(2) Software, Hardware, and Internet Access**

Minimum software requirements are as follows:

1. An Operating system such as Windows 2000 or later.
2. An Internet browser Explorer Version 6.1 or later.

Minimum hardware requirements are as follows:

1. Pentium-based (or equivalent) workstation or laptop with a minimum of 64 MB of RAM.
2. A scanning device capable of scanning a minimum of 11-inch x 17-inch color document into electronic Portable Document Format (PDF) with a minimum density of 300 dpi.
3. A full-size plan scanner.

Minimum access requirements are as follows:

1. Broadband connection using integrated Services Digital Network (ISDN), Digital Subscriber Line (DSL), or better.

Contractor shall be responsible for his costs associated with the provisions, maintenance, and upgrade of the hardware, software, and Internet access needed for using EADOC for the duration of the Contract.

Contractor shall be responsible for all software necessary to create documents in format compatible with EADOC or to convert non-electronic documents to such formats. Compatible formats include: Word, Excel, AutoCAD, and PDF.

**1.12.9 Restrictions and Limitations**

All Project Communications submitted to the Owner through EADOC after 3:00 PM, Monday through Friday, will be acknowledged no earlier than the following business day. For Project Communication purposes, business days and hours are defined in Section 1-01.3.

User access rights to the EADOC site will restrict access to this Contract only. Access permission levels will be established by the Owner and Construction Manager.

**1.12.10 Owner Responsibility**

Owner shall:

1. Provide the Contractor with EADOC Use Guidelines within seven days of the effective date of Notice to Proceed.
2. Provide user access to the EADOC system for the duration of the Contract.
3. Manage the permissions level for all users of the system.
4. Provide EADOC training for personnel using the system for each EADOC user identified by the Contractor.
5. Provide technical support (administration) for EADOC, acting solely through and at the request of the Owner.
6. Provide guidelines regarding the organization and format of the EADOC modules and the access permission requirements for each module or element thereof.
7. Allow users to upload, download, view, and markup files, based on permissions.
8. Track history of revisions and activities with respect to each document submitted or managed within EADOC.
9. Adjust and revise the folder structure as necessary to facilitate management of Project Communications.

With the prior approval of Owner, exceptions may be made to allow specific items to be transmitted, submitted, responded to, or distributed in hard copy only. In these instances, EADOC shall be used to track and expedite processing of these items. Refer to Section 1-12.5 above.

**END OF SECTION 1-12**



# SECTION 01 12 16 WORK SEQUENCE

## PART 1 : GENERAL

### 1.01 SUMMARY

- A. This Section includes general sequencing, project phasing and coordination requirements for the Work.
  
- B. Contract Requirements:
  - 1. The existing Bangor-Keyport Force Main and Pump Stations 17, 24, 64, and 67 continuously receive raw sewage. The functions of these facilities shall not be compromised during the course of the Work, except as specified herein. Plan and prosecute the Work such that the operation of the force main and pump stations is not interrupted, except as specified herein.
  - 2. The Contractor is responsible to plan, schedule, and sequence all construction activities in conformance with the Contract Documents.
  - 3. In order to maintain reliable sewer service, comply with permit and regulatory requirements and conditions, and work within the project constraints defined herein the Contractor shall sequence work as necessary. The Contractor shall develop a Construction Sequencing Plan to demonstrate the ability to complete the Work within the requirements of the Contract Documents.

### 1.02 DEFINITIONS

- A. Bypass: Secondary routing of flows to facilitate the isolation of portions of wastewater system.
  
- B. Temporary Shutdown: Suspension of pump station function.

### 1.03 RELATED SECTIONS

- A. Section 01 59 00, Temporary Sewer Bypass Systems.

### 1.04 SUBMITTALS

- A. Submit in accordance with the provisions of Section 1-06 – Control of Materials.

- B. Work Sequencing Plan: At a minimum, to include the following:
1. Complete sequence of construction for all activities contained herein.
  2. Major work activities to occur.
  3. Schedule of bypass operations and estimated duration of bypasses. Submit detailed bypass plans in accordance with Section 01 59 00, Temporary Sewer Bypass Systems.
  4. Schedule of temporary shutdowns of pump stations and estimated duration of shutdowns. Submit a detailed plan for conveying sewage to the downstream collection system during temporary shutdowns.
  5. Listing of equipment to be present on site, including but not limited to temporary pumping and/or hauling equipment to be used to convey sewage around pump stations during temporary shutdowns.
  6. Assistance to be required of Owner's operating personnel during temporary shutdowns.
  7. Contingency plan identifying what action will be taken if activities during a shutdown cannot be completed within the allotted times, or if there is a failure of pumping equipment to be used during temporary pumping operations.
  8. Name and contact information of primary and secondary individuals in charge of activity during shutdown.

#### **1.05 PROJECT SPECIFIC WORK CONSTRAINTS**

- A. Construct force main bypass assemblies prior to any demolition of existing structures and associated electrical, mechanical and control systems. This shall require temporary shutdown of the existing pump systems and draining of the existing force main prior to cutting the force main.
- B. With the force main out of service, Contractor shall be responsible for collecting and transporting raw sewage to the Owner's downstream collection system as required to prevent overflows and sewage spills until the force main bypass assembly is installed and visually inspected and approved by the Engineer.

- C. Utilize the force main bypass assembly and existing force main for all bypass pumping conducted during pump station shutdowns once it is constructed and operational.
- D. Scheduled temporary shutdowns of a pump station and/or force main shall not be approved to occur between 12:00 PM Friday and 9:00 AM Monday and holidays.

#### 1.06 GENERAL WORK CONSTRAINTS

- A. Constraints primarily relate to interfacing with and tying into existing pipelines, power supply, equipment, and other aspects of the operating force main.
- B. Make every effort to give proper attention to each of general work constraint to minimize interruptions of the existing facilities and avoid delays that may result if the constraints are not observed.
- C. Constraints listed below involve limits on activities during construction. These limits relate to the critical nature of the existing force main and associated facilities.
  - 1. Coordinate construction schedule and operation with Owner.
  - 2. Coordinate proposed work with Owner, Engineer, and facility operations personnel before implementing shutdowns. Under no circumstances cease Work at the end of a normal working day if such actions may inadvertently cause a cessation of any facility operating process; in which case, remain on site until necessary Work and/or repairs are complete.
  - 3. Owner recognizes portions of the facility and facility operations will have to be interrupted or shut down or interfered with in order to accommodate construction activities. Owner will, through its personnel, attempt to accommodate Work, provided that proper notification is given. Owner reserves the right to deny permission for interruption or shutdown on any day.
  - 4. Do not operate any of the existing equipment without written permission from Owner naming the specific piece of equipment, operator(s) and dates equipment may be used. Contractor is liable for any loss or damage caused to property or equipment or any personal injury resulting from or related to this usage.
- D. Extended Working Hours: If it is desired to perform any Work outside the specified working hours, obtain written permission from Owner and all necessary permitting agencies, and make all necessary arrangements prior to commencing.

**1.07 TEMPORARY SHUTDOWNS**

- A. Provide minimum 14 calendar days advance written notice to request approval of a temporary shutdown of a facility.
- B. Each Notice of Request for Approval of a Temporary Shutdown submitted to Owner shall include the following:
  - 1. Dates, times, and duration of proposed shutdown.
  - 2. Work activities to be performed during the shutdown.
  - 3. Assistance required of Owner's personnel before, during, and after shutdown.
  - 4. Personnel to be on Site during shutdown.
  - 5. Proposed plan for conveying sewage from facilities to downstream conveyance system.
  - 6. Contingency plan if work during shutdown is not completed during allotted time or critical equipment fails.
- C. Upon receipt of such request, Owner will decide what action(s) is required by Owner and if the requested shutdown is acceptable. The request from Contractor will be returned to Contractor with the Owner's written decision noted. If Owner deems that the requested shutdown is unacceptable, Owner will state such reasons, and Contractor shall reschedule the shutdown as required.
- D. It is hereby agreed between the Contractor and Owner that disapproval by Owner of the Contractor's shutdown request does not entitle Contractor to any time extension unless Contractor can demonstrate to the satisfaction of Owner, through an updated CPM schedule, that the overall Project completion date will not be met as a result of this disapproval.
- E. Owner may postpone a planned and approved shutdown at any time for pumping capacity, safety or operational reasons.
- F. Contractor shall provide temporary bypass pumping system during temporary shutdowns as required and as specified in Section 01 59 00, Temporary Sewer Bypass Systems, unless otherwise approved by the Engineer.

**1.08 INTERRUPTION OF UTILITY SERVICE**

- A. Indicate required shutdowns of existing utilities or interruptions of existing operations on Progress Schedule. Interruptions to utility service will be allowed to the extent that customer service will not be adversely compromised.
- B. Submit written requests for interruptions to utility service not less than 14 calendar days in advance of the date scheduled for the interruption.
- C. Following receipt of the request, Engineer will notify Contractor if the requested date will be permitted. Evaluation of the request will be based upon the availability of the utility Owner's personnel to assist and monitor utilities during the shutdown period and impact to customer service.
- D. Minimize the period of interruption by thorough advance planning. Procure and provide all required materials, equipment, and labor on site during the shutdown.
- E. Do not begin interruption until written authorization is received from Engineer.
- F. Customer Sewer Service Interruption:
  - 1. The project will require interruption in sewer service for customers during construction. The Contractor shall notify the County Construction Manager not less than seven calendar days in advance of service interruption and shall indicate the estimated length of time the service will be interrupted. Temporary sewer bypass systems for an individual customer or customers may not be required provided the following conditions are met:
    - a) Interruption in service shall be minimized and shall be limited to a maximum 6-hour period, to occur during the hours of 9 AM to 3 PM
  - 2. The Contractor shall provide and bear all costs for temporary sewer bypass systems in accordance with the Contract if the above conditions cannot be met, unless otherwise approved by the County Construction Manager.

**1.09 CONSTRUCTION SEQUENCING PLANS**

Suggested Construction Sequencing Plans, included as Appendix C, have been developed to assist the Contractor in understanding the anticipated sequence of work and project constraints. Suggested Construction Sequencing Plans are for reference only and are intended to inform the development of the Contractor's Construction Sequencing Plans as defined herein.

The Contractor retains discretion to exercise its judgment in following or altering the Suggested Construction Sequencing Plans provided as Appendix C when preparing its Work Sequencing Plans as defined herein.

**PART 2 : PRODUCTS**

NOT USED

**PART 3 : EXECUTION**

NOT USED

**END OF SECTION**

**SECTION 01 59 00**  
**TEMPORARY SEWER BYPASS SYSTEMS**

**PART 1 : GENERAL**

**1.01 SUMMARY**

Work covered in this section includes the requirements for temporary sewer bypass systems. The means and methods of accomplishing and maintaining the bypassing shall be the sole responsibility of the Contractor.

Continuous operation of the Owner's facilities is of critical importance. Contractor shall schedule and conduct activities to enable existing facilities to operate continuously, unless otherwise specified. Contractor shall not proceed with work affecting a facility's operation without obtaining Owner's and Engineer's advance written approval of the need for, and duration of, such work. Where existing facilities are to be modified during the course of work, the Contractor shall obtain Engineer's review of submittals for temporary bypass, temporary shutdown, demolition, modification, connections between new and existing work, and other related work and shall conform to other Contract conditions as applicable.

The Owner and Engineer consider the Contractor's schedule and construction sequencing to be paramount to ensure the work is properly planned, coordinated, and executed. A number of pump stations feed or are fed by the facilities that will be replaced by the work under this contract. The pump stations are currently, and continuously receiving and pumping sewage and their functions cannot and shall not be interrupted except as specified herein or as specifically allowed by the Owner. The Contractor shall properly coordinate and execute the work to avoid interference with normal operations.

The Contractor shall anticipate that multiple temporary sewer bypass systems will be required over the duration of construction to construct the proposed improvements given the specified work constraints and separated project site locations.

Connection to existing services or utilities, or other work that requires temporary shutdown of any existing operations or utilities shall be planned in detail with appropriate scheduling of the work and coordinated with the Contracting Agency or Engineer.

Contractor shall be solely responsible for developing the sequence of the work and for ensuring that current operations are not interrupted or compromised. At least three weeks prior to starting the work, Contractor shall confer with the Engineer and Owner to develop a work schedule that will permit facilities to function as normally as practical. Certain parts of the construction work may be required outside normal working hours in order to avoid undesirable conditions, including work during low flow periods (between the hours of 12 am and 5 am). Temporary sewer bypassing will be required to complete portions of the work. Such work shall be minimized to the extent possible through proper sequencing and execution of the work. Contractor shall do this work at such times and at no additional cost to the Contracting Agency. Connections between existing facilities and new work shall not be made until all necessary inspection and tests have been completed on the new work and the new work is found to conform in all respects to the requirements of the Contract Documents.

Contractor shall provide all temporary pumps, piping, and tanker trucks and be responsible for filling tanker trucks, hauling, and properly disposing of sewage. The

Contractor shall schedule and conduct work in a manner that will minimize the number of times and length of time that temporary bypass pumping is required.

## 1.02 SUBMITTALS

- A. Submit in accordance with the provisions of Section 1-06 – Control of Materials.
- B. Submit details of proposed temporary sewer bypass system(s).
  - 1. Bypass Plan: detailed explanation of the proposed sewer bypass system(s), including project specific plans, details, sequencing, duration, and assistance required of the Owner. Bypass Plan shall be stamped and signed by a professional engineer registered in the State of Washington. The Bypass Plan shall contain, at a minimum, a plan view of each proposed sewage diversion on a site map and the individual components of the diversion including but not limited to:
    - a. Pumps: type, size, and placement.
    - b. Diversion pipe: size, type, and placement
    - c. Power supply to pumps.
    - d. Method of damming the flow.
    - e. Facilities for redundancy.
    - f. Anticipated peak daily flow.

Suggested Bypass Plans, Appendix D have been developed to assist the Contractor in understanding the anticipated bypass operations and project constraints. Suggested Bypass Plans are for reference only and are intended to inform the development of the Contractor's Bypass Plans as defined herein. The Contractor retains discretion to exercise its judgment in following or altering the Suggested Bypass Plans provided in Appendix D when preparing its Bypass Plans as defined herein.
  - 2. Proposed pumping equipment including pump performance data.
  - 3. Engineering analysis and calculations for each sewer bypass system including system head vs flowrate curves.
  - 4. Spillage cleanup plan.
  - 5. Description of control equipment and temporary control panel(s) and method to be used to operate the pumps.
  - 6. Pump maintenance plan describing regular maintenance to be performed while the pumps are in service and the length of the maintenance period when a pump will be out of service.
  - 7. Contingency plan describing steps to be taken if a pump fails and emergency contact phone numbers.
  - 8. Noise levels at minimum and maximum operating speed.
  - 9. Alarms sent to OWNER's central control facility.
- C. Temporary Bypass Qualifications.



**1.03 CONTRACTOR RESPONSIBILITY****A. BYPASS SYSTEM REQUIREMENTS**

1. Spills or bypassing of untreated or partially treated wastewater to surface waters or drainage courses is prohibited during construction. In the event accidental bypassing is caused by the Contractor, the Owner shall immediately be entitled to employ others to stop the bypassing in accordance with the Contract Documents with cost borne by the Contractor. Contractor shall be fully responsible for any damage that may result from inadequate or improper installation, maintenance or operation, or failure of any kind of the temporary sewer bypass system.
2. Costs incurred by the Contractor or Owner, including penalties imposed on the Owner as a result of any sewage spill or bypassing of untreated or partially treated wastewater to surface waters or drainage courses caused by the actions of the Contractor, its employees, or subcontractors, shall be borne in full by the Contractor, including legal fees and other expenses to the Owner resulting directly or indirectly from the spill and/or bypass.
3. Precautions and Protective Measures:
  - a. Review existing sewer system plans with the Engineer and Owner.
  - b. Verify the size and location of connecting laterals and side sewers.
  - c. Provide pumps with sufficient capacity and head.
  - d. Provide pumping equipment redundancy and/or standby equipment that can be readily deployed.
  - e. Investigate upstream manholes.
  - f. Check and test pumping equipment and bypass system(s).
  - g. Provide suitably experienced person(s) and training personnel (more than one individual) for operation and maintenance of the system(s), including dealing with emergencies.
  - h. Check upstream manhole surcharging after bypassing operations have commenced.
  - i. Properly monitor and maintain system during operation.
4. Quality Assurance:
  - a. Temporary sewer bypass systems shall be designed, stamped, and signed by a registered professional engineer in the State of Washington. Engineer shall have demonstrated experience in the design of pumping systems of comparable size and complexity.
  - b. Before commencement of any bypassing operation, the Contractor shall obtain the Engineer's acceptance of the Bypass Plan including design, equipment and materials, installation, operation, and maintenance.

- c. Temporary Bypass Qualifications: Contractor shall have a minimum of five years' experience in performing substantially similar temporary bypass operations and shall submit evidence of satisfactory operation of temporary bypass facilities similar to those specified for at least five projects in accordance with the Specifications.
5. Sewer Bypass System Description:
    - a. Contractor will be responsible for properly operating, protecting, maintaining, and servicing the bypass equipment for the duration of the temporary bypass. Contractor shall be responsible for bypass pumping equipment, electrical service, fuel, and all other appurtenances and consumables required for operation of the temporary sewer bypass system.
    - b. Noise levels of equipment shall meet the requirements of Kitsap County and Washington State noise level requirements. Depending on the pumping equipment that is used, meeting this requirement may require the use of sound attenuating enclosures as well as other provisions and measures. If possible, existing power supplies should be used to power the bypass pumping equipment so as to avoid engine-driven pumping units or engine generators. If engine-driven pumps or engine generators are used, equipment shall be located as far from residences as possible. Depending on the situation and subject to the approval of the Owner, the only possible exception or relaxation of this requirement will be in cases where the bypassing equipment will only be operated: 1) during the work week; 2) during normal working hours and; 3) period of bypass operation will be less than one week.
    - c. Each sewage diversion pump shall operate as a single pumping unit. A minimum of two primary sewage diversion pumping units shall be operated in parallel to by-pass pump the total anticipated peak sewage flow. For system redundancy, the Contractor shall have on site a minimum of two back-up sewage pumping units for system redundancy. The back-up sewage pumping units shall be of the same capacity as the two largest primary pumping units. Pumps shall be non-clog sewage pumps capable of pumping spherical 3-inch solids. Bypass pressure pipe shall be in good condition with watertight joints. Provide H-20 rated ramps over pipe for vehicle access if needed. Higher rated ramps may be required where exposed to commercial traffic.
    - d. The temporary sewer bypass system shall be designed to handle a minimum capacity for the sources connected to the temporary bypassing. The pump capacity shall be able to maintain adequate cleaning velocities (>3.5 fps) within the temporary piping as required.

- e. Maintain on-site sufficient equipment, parts, materials, and fuel to ensure continuous and uninterrupted operation of the bypass system(s). A minimum of 24-hours of fuel shall be maintained on-site. Standby pumps and generators shall be fueled and operational at all times. Contractor's personnel shall be knowledgeable and trained on how to operate and maintain the bypass equipment.
  - f. All monitoring shall be fully functional during bypassing.
  - g. If the bypass system is to be operated when the Contractor is not on-site, the system shall be provided with a monitoring and alarm system that notifies the Contractor and Owner 24 hours a day of a system failure. In the event of a failure, Contractor shall respond immediately and fix the cause of the problem. Contractor shall be on-call 24 hours a day and be able to respond within 30 minutes at all times during sewer bypassing. The Contractor will be required to demonstrate to the satisfaction of the Owner that this requirement can be met, and that responsible and appropriately trained personnel will be able to deal with emergencies that could arise. The Contractor is encouraged to consider retaining a company or individual(s) that specialize in the operation and maintenance of bypass sewer systems that require unattended operation.
  - h. Where approved, existing sewage pumps and monitoring systems at the Owner's pump station may be used for bypassing operations, provided that the Contractor clearly defines the proposed bypass plan per Section 1.02-B.
  - i. Sewer bypassing shall not cause backup of sewage into residences or conveyance systems. Depth of surcharge upstream shall be kept to the minimum necessary. The Contractor will be responsible for repairing any damage to upstream property due to surcharging of the system.
  - j. All sewer pipes and manholes that were surcharged shall be properly flushed to remove accumulated sewage material.
  - k. If damaged, restore bypass areas to pre-existing conditions in accordance with the requirements of the Contract Documents.
6. Spills:
- a. Contractor is fully responsible for any damage that may result from an inadequate or improper installation, maintenance or operation, or failure of any kind of the bypass system. That responsibility includes but is not limited to the costs associated with cleanup and repair of property damage.
  - b. Spills or bypasses of sewage to surface waters or drainage courses is prohibited. In the event of sewage spills, the Contractor shall immediately take whatever actions are deemed necessary to stop a spill. Should the Contractor not take immediate action, the Owner will be entitled to take whatever actions are deemed necessary to stop a spill.

- c. Costs incurred by the Contractor or Owner, including penalties imposed on the Owner as a result of any sewage spill caused by the Contractor, its employees, or subcontractors, shall be borne in full by the Contractor, including legal fees and other expenses to the Contractor or Owner resulting directly or indirectly from the spill.
- d. The Contractor shall be responsible for providing the following information to the Construction Manager and/or Owner in case of a spill or release:
  - 1) Release location
  - 2) Date and time release found or started, and time stopped
  - 3) Release flow rate and estimated total volume
  - 4) Receiving waters, if any
  - 5) Action taken to stop release
  - 6) Cause of release
  - 7) Clean-up actions taken
  - 8) Any other information as requested by relevant authorities
- e. In case of sewage release during bypass operations, the Contractor shall immediately contact the Kitsap County Sewer Utility Construction Manager.

A representative of Kitsap County shall report the sewage spill within 24 hours to the Washington State Department of Ecology and any other appropriate entities. Even if a sewage spill or release is contained within an excavation, the spill or release must be reported.

- 7. Work and Assistance by Owner:
  - a. Operation of the existing pump station facilities, including those operations which may be necessary to facilitate the Contractor's work will be provided by the Owner.
  - b. For minor assistance and operations, the Contractor shall provide a minimum of 3 days advance notice to the Construction Manager. When major assistance or the Contractor's work needs to be done during the low flow period, which will require coordination of more than one individual, or more than a few hours of one individual of the owner's personnel, Contractor shall provide a minimum of 14 days advance notice to the Construction Manager.
  - c. The Contractor shall not at any time undertake to close off any lines or open valves or take any other action which would or might affect the operation of any part of the Owner's existing systems without first discussing it with the Construction Manager and/or Owner. Unless permission is specifically granted, the Owner or responsible utility will open and close valves.
- 8. Temporary Construction Easement and Right of Entry Acquisition

- a. Where required to facilitate temporary bypass system, Contractor shall coordinate with Kitsap County to acquire temporary construction easements and right-of-entry agreements with affected property owners.

**PART 2 : PRODUCTS**

**2.01 PUMPS**

- A. Number of Pumps: The temporary bypass pumping system shall include a minimum of two primary pumps and two backup pumps (see Section 1.03.A.5.c above) and shall provide full pumping capacity with the largest pump offline, as described above. The offline pump is referred to herein as the standby pump. All pumps shall be set up for automatic operation based on water level.
- B. Acceptable manufacturers:
  - 1. Godwin Pumps
  - 2. Rain for Rent
  - 3. Sunbelt
  - 4. Screwsucker
  - 5. Xylem
  - 6. Approved equal
- C. Use of Owner's Pumps: Where approved by the Engineer, existing pump station sewage pumps may be used in place of temporary bypass pumps.

**2.02 TEMPORARY PIPING**

- A. Provide temporary piping, valves, and fittings for temporary bypass system.
- B. Provide pipe or hose and couplings rated for 200% of operating pressure. Temporary bypass discharge piping shall be ductile iron (DI), HDPE or high-pressure discharge hose.
- C. Use of Bauer style (Ball & Socket) connections or joints is not allowed. All joints and fittings shall be fully restrained.
- D. Temporary piping provided by the Owner may be used for bypassing operations if said piping meets the requirements specified herein. The miscellaneous pipe and fittings potentially available by the Owner is provided in the table below.

Qty	Description
6,600 FT	18" IPS DR 26 HDPE Pipe
11	18" 90-Degree Elbow DR 26 HDPE
26	18" 45-Degree Elbow DR 26 HDPE
4	18" 22.5-Degree Elbow DR 26 HDPE
34	18" Backup Ring HDPE DR 26 FLG
34	18" Adaptor FLGxBW HDPE DR 26
6	18" Service Saddle x 4" FNPT HDPE DR 26
1	18" Tee HDPE DR 26
386 FT	30" IPS DR 11 HDPE Pipe
1	30" 22.5-Degree Elbow BW HDPE DR 26
6	4" Ball Valve FNPT
4	Air/Vacuum Assemblies
1	24"x18" FLG Concentric Reducer DI

### PART 3 : EXECUTION

#### 3.01 TEMPORARY PIPING

- A. Temporary piping shall be installed to facilitate both suction and discharge from the temporary bypass pumping system. All piping shall be leak-tight, allowing no raw sewage spills of any amount.
- B. Route temporary piping to avoid blocking construction equipment and vehicular traffic including residential property access. Provide protection for piping, valves and fittings where crossing access points is unavoidable. At traffic crossings bypass piping shall be buried or arranged such that the piping is protected from traffic loads.

#### 3.02 TEMPORARY PUMPING

- A. Do not disrupt normal path of raw sewage flow except as allowed to make temporary connections, as approved by the Owner.
- B. Contractor shall be responsible for operation and maintenance of temporary pumps.
- C. The location and layout of the temporary pumping system, and associated noise control, shall be designed and provided by the Contractor.

#### 3.03 ALARMS AND TELEMETRY

- A. The temporary pumping system shall provide the following alarms for remote monitoring:
  - 1. High water alarm – at depth of 2 feet in suction location unless otherwise limited or approved by Owner.
  - 2. Standby pump called to operate.
  - 3. Pump failure.
- B. Contractor shall provide a monitoring system and staff to monitor the alarms on a 24-hour basis, 7 days a week during temporary pumping and bypass operation.

**3.04 FIELD TESTING**

- A. Contractor shall conduct field testing of all components of the temporary pumping system to demonstrate adequate capacity, operation, and monitoring requirements. A field test report, listing the completed tests, shall be submitted to the Construction Manager for approval. The testing program shall include a witnessed operational test of the completed system. A one-week notice shall be provided to the Construction Manager to witness the test.
- B. Bypass piping, valves and fittings shall be successfully leak tested prior to being placed into service. Leak testing shall be witnessed by the Construction Manager. Allowable leaking is zero.

**3.05 OPERATION**

- A. Contractor shall respond to and resolve all alarms from temporary pumping and bypassing operations. Contractor's point of contact shall be located within 30 minutes of the project site to ensure rapid response to alarms.
- B. Contractor shall be responsible for ensuring that the temporary bypass system is maintained and remains operational 24 hours per day 7 days per week for the duration of any Contractor planned bypass.
- C. Contractor shall notify the Owner immediately in the event of a high water or

pump failure alarm. Owner will provide Contractor with names and telephone numbers of personnel to be contacted in the case of an alarm or other emergency.

- D. Contractor shall maintain existing alarm signals to the Owner's alarm system, including high water, at all times during construction.
- E. No sewage bypass operations may proceed unless the Contractor has, at the work site, the following items:
  - 1. Equipment to secure the area of sewage release and isolate the public from accessing the release site. As a minimum, this shall include barricades and caution tape.
  - 2. The equipment and materials, on hand, to stop the release and repair the failed item.
  - 3. Equipment and materials to clean the site, rake up solid debris and to dispose of material properly.
- F. Contractor shall maintain a daily inspection and maintenance log of the bypass system. Log shall be submitted daily to the Construction Manager.

**END OF SECTION**



**SECTION 02 41 00**  
**DEMOLITION, CUTTING, AND PATCHING**

**PART 1 : GENERAL**

**1.01 SUMMARY**

- A. Section includes:
  - 1. Demolition, cutting, and patching of existing facilities where shown on Drawings, or as required to accommodate new work shown or specified.
  - 2. Abandoning existing pipes, utilities, vaults, and structures.
  - 3. Removing and disposing of demolished equipment, asphalt concrete, and other materials. The removed equipment and materials shall be properly disposed of at the Contractor's expense.

**1.02 SUBMITTALS**

- A. See Section 1-06 – Control of Materials for requirements for the mechanics and administration of the submittal process.
- B. Demolition Schedule: Indicate overall schedule and interruptions impacting utility and facility services.
- C. Indicate manufacturer and type of proposed materials and methods to be used for matching and repairing existing construction.
- D. Indicate demolition and removal sequence, and location and construction of temporary work.

**1.03 QUALITY ASSURANCE**

Conform to applicable codes and Operational Safety and Health Administration (OSHA) requirements for demolition work, dust control, products requiring electrical disconnection and reconnection, and mechanical system decommissioning.

**1.04 DELIVERY, STORAGE, AND HANDLING**

NOT USED

**1.05 PROJECT CONDITIONS**

- A. Perform preliminary investigations as required to ascertain extent of work.
- B. Conduct demolition to minimize interference with adjacent areas.

**1.06 SEQUENCING AND SCHEDULING**

- A. Coordinate and reschedule work as required to preclude interference with other operations.

- B. Do not remove or abandon existing sanitary sewer facilities until the new sanitary sewer systems or temporary pumping systems are fully operational, unless noted otherwise on the Drawings.

**PART 2 : PRODUCTS**

**2.01 ACCEPTABLE MANUFACTURERS**

- A. Subject to compliance with the Contract Documents, the following products and manufacturers are acceptable:
- B. Non-shrink grout:
  - 1. Masterflow 713 Plus by BASF Building Systems.
  - 2. Sika Grout 212 by Sika.
  - 3. Five Star Grout by Five Star Products, Inc.
- C. Epoxy bonding adhesive:
  - 1. Euco No.452 MV by Euclid Chemical Co.
  - 2. Sikadur 32, Hi-Mod by Sika Corporation.
- D. Epoxy patch:
  - 1. Depth of patch:
    - a. Greater than 3/4 IN: Five Star MP Epoxy Patch.
    - b. Between 1/8 IN and 3/4 IN: Five Star Fluid Epoxy.
- E. Submit request for substitution in accordance with Section 1-06 – Control of Materials.

**2.02 MATERIALS**

- A. Non-shrink grout:
  - 1. Nonmetallic, noncorrosive, and non-staining.
  - 2. Premixed with only water to be added in accordance with manufacturer's instructions at jobsite.
  - 3. Grout to produce a positive but controlled expansion:
    - a. Mass expansion not to be created by gas liberation or by other means.
  - 4. Minimum compressive strength at 28 days to be 6500 psi.
  - 5. Coat exposed edges of grout with a cure/seal compound recommended by grout manufacturer.
- B. Epoxy bonding adhesive:
  - 1. Two component, moisture insensitive adhesive manufactured for the purpose of bonding fresh concrete to hardened concrete.

- C. Controlled density fill (CDF):
  - 1. See Specification Section 31 23 33 – Trenching, Backfilling, and Compacting for Utilities for requirements for CDF.

**PART 3 : EXECUTION**

**3.01 PREPARATION**

- A. Notify affected utility companies before starting work and comply with their requirements.
- B. Mark location and termination of utilities.
- C. Provide covered passageways where necessary to ensure safe passage of persons in or near areas of work.
- D. Provide substantial barricades and safety lights as required.
- E. Provide temporary dustproof partitions, where indicated or necessary.
- F. Prevent infiltration of dust into occupied areas.
- G. Provide temporary weather protection as necessary.

**3.02 INSTALLATION**

- A. Cutting and removal:
  - 1. Remove existing work indicated to be removed, or as necessary for installation of new work.
  - 2. Neatly cut and remove materials, and prepare all openings to receive new work.
- B. Abandon structures, manholes, and vaults:
  - 1. Remove equipment to be disposed of.
  - 2. Demolish structures, manholes, and vaults as shown on the Drawings.
  - 3. Fill remaining structures with CDF, sand, or other material approved by the Engineer unless otherwise shown on the Drawings.
  - 4. Backfill and compact excavated areas as shown on the Drawings.
- C. Abandon pipe:
  - 1. Completely fill pipe to be abandoned with CDF by pumping CDF into the pipes. Cap pipes with concrete plugs, mechanical cap, or other method approved by the Engineer.

- D. Remove pipe:
1. Where shown on the Drawings or at other locations as determined by the Construction Manager, cut and remove pipe in its entirety regardless of the size or type.
  2. Backfill and compact voids left by pipe removal with suitable backfill material.
  3. All removed materials shall become property of the Contractor and shall be properly disposed of outside the project limits.
- E. Modification of existing concrete:
1. Where indicated, remove existing concrete and finish remaining surfaces:
    - a. Protect remaining concrete from damage.
    - b. Make openings by sawing through the existing concrete.
    - c. Break out concrete after initial saw cuts in the event concrete thickness prevents cutting through.
    - d. Make openings by drilling holes around perimeter of opening and then chipping out the concrete where sawing is not possible:
      - 1) Holes shall be sufficient in number to prevent damage to remaining concrete.
  2. Oversize required openings in existing concrete 1 IN on all sides and build back to required opening size by means of non-shrink grout epoxy bonded to the existing concrete.
  3. Where oversized openings cannot be made, remove the concrete to the required opening size and cut back exposed reinforcing 1 IN from face of concrete and fill resulting holes with non-shrink grout.
- F. Clean up: transport debris and legally dispose of off-site.

### 3.03 ASPHALT AND CONCRETE REMOVAL AND REPLACEMENT

- A. All concrete and asphalt requiring removal and replacement shall be neatly saw cut full depth prior to removal.
- B. Debris resulting from the above operations shall be removed, hauled off-site, and disposed of at the Contractor's expense.

### 3.04 GRAVEL SURFACED DRIVES AND ROADWAYS

The Contractor shall restore all damaged gravel surfaced drives and roadways to a condition equal to or better than the original condition.

### 3.05 TREES

Do not remove trees without written instructions from the Engineer unless tree removal is shown on the Drawings.

**3.06 FENCES, SIGNS, MAILBOXES, ETC.**

Restore all damaged fences, signs, mailboxes, etc., to their original conditions.

**END OF SECTION**

THIS PAGE INTENTIONALLY LEFT BLANK

# SECTION 03 60 00 GROUT

## PART 1 : GENERAL

### 1.01 DESCRIPTION OF WORK

- A. This Section covers the supply of materials, mixing of materials, and the installation of various grades of grouts utilized in the project, for general purposes.

### 1.02 STANDARDS AND CODES

- A. Referenced Standards and Publications: This Section incorporates by reference the revision of the following documents in effect 30 days prior to bid.

- 1. ASTM STANDARDS

- a. C404 Standard Specification for Aggregates for Masonry Grout
- b. C939 Standard Test Method for Flow of Grout for Preplaced-Aggregate Concrete (Flow Cone Method)
- c. C1107 Standard Specification for Packaged, Dry, Hydraulic Cement Grout (Nonshrink)

### 1.03 SUBMITTALS

- A. Submit under provisions of Division 1 as follows:
  - 1. Manufacturer's data on all products.

## PART 2 : PRODUCTS

### 2.01 EPOXY-RESIN-BASE BONDING SYSTEM

For all grouted pipe penetrations, where called for on the drawings and in all cases where less than a 13-inch thickness of grout or mortar overlays existing concrete or green concrete, a bonding system complying with ASTM C881 shall be used.

### 2.02 PRECISION GROUT

- A. Filling of anchor bolt pockets, handrail pockets, and under equipment and column base plates shall be classified as precision grouting.
- B. Grout used for precision grouting shall be a pre-packaged, non-shrink grout using a mixture of metallic and natural aggregates, and shall conform to the most current version of ASTM C1107 Grade B or C when tested at a fluid consistency of 25-30 seconds per ASTM C939 at temperature extremes of 45 and 90°F and an extended working time of 30 minutes.
  - 1. BASF Masterflow 713 Plus or Masterflow 885 are acceptable brand and grout types conforming to this specification.
  - 2. All material used, including water, mixer and pre-packaged grout must be initially within the 45 and 90° limits when testing is initiated.

3. Manufacturer shall provide independent certification of ASTM C1107, compliance without modification of standard methods, and certify that the grout's post-hardening, non-shrink property is not based on gas expansion.
- C. Grout shall have strengths of 3000 psi at 3 days, 5000 psi at 7 days, and 7000 psi at 28 days when cured at 72°F, as well as meet the 3-, 7-, and 28-day strengths when tested and cured at the 45 and 90°F limits, and shall not bleed when placed at a fluid consistency.

### 2.03 PORTLAND CEMENT GROUT

- A. Portland Cement Grout shall be used to provide flow concentration in channels, at the bottom of high walls, and in other locations where a general-purpose grout is required.
- B. Portland cement grout shall be mixed with sand on a ratio of one part cement to two parts sand with an expansive agent included to limit drying shrinkage.
- C. Sufficient water shall be added for placement while maintaining a minimum 4,500 psi 28-day compressive strength.

### 2.04 TOPPING COURSE GROUT

- A. This grout shall be used for leveling the bottom of structures.
- B. This mix shall contain 6½ sacks of cement per cubic yard of concrete, use sand and 3/8-inch course aggregate, size No. 89 in ASTM C404, and use water-reducing and expansive additives.
- C. The minimum compressive strength shall be 4,500 psi in 28 days.
- D. Topping grout over floor slabs shall be reinforced with WWR 6x6 W1.4xW1.4.

### 2.05 RAPID CURE GROUT

- A. Rapid cure grout shall be mixed with aggregate as recommended by the manufacturer.
- B. The grout shall be BASF MasterEmaco T545 or equal.
- C. The minimum compressive strength shall be 4,500 psi in 28 days.

### 2.06 SELF-LEVELING UNDERLAYMENT

- A. Self-leveling cement underlayment shall be Ardex K-15.
- B. The compressive strength shall be 4,500 psi per ASTM C109 and shall be capable of feather-edge thickness application.
- C. Self-leveling cement underlayment shall be used to level floors where noted on the drawings.



**PART 3 : EXECUTION****3.01 MIXING**

- A. All parts of the respective grouts shall be proportioned by volume measurement.
- B. Mixing shall be accomplished using a mechanical mixer suitable to the required quantities.
- C. Each batch shall be mixed for not less than 5 minutes.
- D. The respective grouts and mortars shall be mixed with sufficient water to maintain the fluidity required while attaining the minimum compressive strength indicated.

**3.02 RETEMPERING AND TIME LIMIT**

- A. Do not retemper or use mortar which has become harsh and nonplastic.
- B. When mortar has been maintained plastic and grout fluid, they may be used up to, but not more than, one hour after original mixing.

**3.03 TEMPERATURE**

Grouting operations shall not commence when the ambient temperature has dropped below 45°F or when the surface to which it is being applied is less than 40°F.

**3.04 PROTECTION**

All grouting operations shall be protected against moisture intrusion and a sealer, linseed oil or Thoroclear 777, shall be applied at the completion of the work.

**3.05 SURFACE PREPARATION**

- A. The existing concrete surface that the respective grout or mortar shall be placed against shall be cleaned as follows:
  - 1. If the existing surface has been exposed to sludge, chlorine, or other solutions, or was previously painted or treated, the surface shall be sandblasted and steam-cleaned, then treated with a diluted solution of muriatic acid neutralized with an alkaline solution and flushed with clean water.
  - 2. If the existing surface was not exposed to solution other than water, then the surface shall be washed with a diluted (2 parts water to 1 part acid) solution of muriatic acid, neutralized with an alkaline solution, and flushed with clean water.

**3.06 PRECISION GROUTING**

- A. This Section describes additional special provisions for the grouting of anchor bolts, handrail pockets, and column and equipment baseplates, defined herein as precision grouting.

- B. All grout used for precision grouting shall be placed in a fluid consistency, with an efflux time of 25 to 30 seconds through a standard flow cone as defined by ASTM C939. The Contractor shall have a standard flow cone on-site to verify grout consistency prior to placement.
- C. Contractor shall not mix more grout than can be placed in approximately 10 minutes. Contractor shall not attempt to retemper grout by adding water or remixing after it stiffens.
- D. All grout used for filling under column and machinery base plates shall be placed from one side using a form around the grouted area. A beveled form edge shall be provided on one side to help direct the grout flow under the base plate. Do not vibrate grout. Immediately after placement, trim the surfaces with a trowel and cover the exposed grout with clean, wet rags and maintain this moisture for 4 to 6 hours.
- E. Forms and excess grout shall be removed after the grout has achieved initial set. The grout should offer stiff resistance to penetration with a pointed mason's trowel prior to removing the grout forms. Exposed shoulders shall be finished and wet cured immediately after form removal, and until grout has reached final set, but not less than 48 hours, followed by two coats of curing compound.

**END OF SECTION**

**SECTION 09 96 00  
PAINTING AND PROTECTIVE COATINGS**

**PART 1 : GENERAL**

**1.01 SUMMARY**

- A. This Section specifies high performance industrial coatings and their surface preparation for non-building applications.
- B. Definitions: Coating systems include surface description, surface preparation, required dry film thickness (DFT), and the number and application procedure of the prime and finish coatings as specified in the Coating System Specifications Sheets, located in Paragraph 2.02.

Field coating is the application or the completion of application of the coating system after installation of the surface at the site of the work.

Installer or applicator is the person actually installing or applying the product in the field at the Project site. Installer and applicator are synonymous.

**1.02 REFERENCES**

- A. REFERENCES:
  - 1. ASTM International (ASTM).
  - 2. International Concrete Repair Institute (ICRI).
  - 3. National Association of Corrosion Engineers International (NACE).
  - 4. National Association of Pipe Fabricators (NAPF).
  - 5. NSF International (NSF).
  - 6. The Society for Protective Coatings (SSPC).
- B. STANDARDIZATION: Materials, supplies, and articles provided shall be the standard products of manufacturers. Paints in a particular coating system shall be the products of a single manufacturer.

Requests for substitutions, in accordance with Section 1-06 – Control of Materials, will be considered, provided the following minimum conditions are met:

- 1. The proposed coating system shall use an equal or greater number of separate coats to achieve the required dry film thickness.
- 2. The proposed coating system shall use coatings of the same generic type.
- 3. Requests for substitution shall have directions for application and descriptive literature that includes generic type, nonvolatile content by volume, and information confirming that the substitution is equal to the specified coating system.

**1.03 QUALIFICATIONS**

- A. Coating manufacturer's authorized representative shall provide written statement attesting that applicator has been instructed on proper preparation, mixing, and application procedures for coatings specified.
- B. Applicators shall have a minimum of ten (10) years' experience in application of similar products on similar project:
  - 1. Provide references for minimum of three (3) different projects completed in the last five (5) years with similar scope of work.
  - 2. Include name and address of project, size of project in value (painting), and contact person.

**1.04 SUBMITTALS**

- A. In accordance with the requirements of Section 1-06 – Control of Materials, submit the following:
  - 1. Applicator experience qualifications:
    - a. No submittal information will be reviewed until the Engineer has received and approved applicator qualifications.
  - 2. Manufacturer's specifications for each coating system including:
    - a. Acknowledgement that products submitted meet requirements of standards referenced.
    - b. Manufacturer's application instructions.
    - c. Manufacturer's surface preparation instructions.
    - d. If products being used are manufactured by a Company other than listed in Paragraph 2.02 of this Section, provide complete individual data sheet comparison of proposed products with specified products including application procedure, coverage rates, and verification that product is designed for intended use.
    - e. Contractor's written plan of action for containing airborne particles created by blasting operation and location of disposal of spent contaminated blasting media.
    - f. Coating manufacturer's recommendation on abrasive blasting.
    - g. Manufacturer's recommendation for universal barrier coat.
    - h. Manufacturer's recommendation for providing temporary or supplemental heat or dehumidification or other environmental control measures.
    - i. A list of materials proposed to be used.
  - 3. Manufacturer's color charts. Basic colors are indicated in Paragraph 3.05. Final color selection shall be made by the Owner from the submitted color charts.
  - 4. Manufacturer's statement regarding applicator instruction on product use.

5. Informational Submittals:
  - a. Approval of application equipment.
  - b. Applicator's daily records:
    - 1) Submit daily records at the end of each week in which painting work is performed unless requested otherwise by the Engineer's on-site representative.

#### 1.05 DELIVERY AND STORAGE

- A. Materials shall be delivered to the job site in their original, unopened containers, labeled as follows:
  1. Name or type number of material.
  2. Manufacturer's name and item stock number.
  3. Date of manufacture.
  4. Contents, by volume, of major constituents.
  5. Warning labels.
  6. Volatile organic compound (VOC) content.
  7. Storage life.
  8. Any special instructions or directions.
- B. Paints shall be stored in enclosed structures and shall be protected from weather and excessive heat or cold and maintained within the storage temperature range recommended by the paint manufacturer, but in no case stored where the temperature is lower than 40°F or greater than 100°F.
  1. Paint material storage facility shall be monitored with a high-low recording thermometer device.
  2. Flammable materials shall be stored in accordance with State and local codes.
- C. Materials exceeding storage life recommended by the manufacturer shall be removed from the site.

#### 1.06 SPARE PAINT SUPPLIES

The Contractor shall provide one unbroken gallon container of each color and type of coating, solvent, and thinner required in the Specification. These spare paint supplies shall be stored as directed by the County Construction Manager.

### PART 2 : PRODUCTS

#### 2.01 MATERIALS

- A. GENERAL: Coating system shall not be applied until the Engineer has inspected the surface to be coated.

- B. COATING SYSTEMS: Unless otherwise specified, prime coatings may be shop- or field-applied. Shop-applied primer shall be compatible with the specified system. Field coating signifies that coating is applied in place, after installation of the surface. If the shop coating meets the requirements of this Section, the field coating may consist of touching up the shop prime coat to achieve the film thickness, continuity, and coating specified in the Coating System Specification sheets. Damaged and poorly applied shop coatings that do not meet the requirements of this Section shall be removed and the surfaces recoated in accordance with the Coating System Specification Sheets.

Surface preparation shall be as specified for each paint system and in accordance with Paragraph 3.01. Number of coats specified in each system shall be the minimum number of coats applied to provide the required dry film thickness.

For unspecified materials such as thinner, provide manufacturer's recommended products.

- C. MANUFACTURERS: As specified for each Coating System or accepted equal.

## 2.02 COATING SYSTEM SPECIFICATIONS

Coating System	A
Coating Material:	Modified Polyamine Epoxy
Surfaces:	Exterior Concrete Surface
Surface Preparation:	Per manufacturer requirements
Application:	Factory – Exterior Surfaces Field – Interior Surfaces
Coating System:	
Primer/Finish:	Tnemec Series 141 Epoxoline One coat, 16 mils DFT

Coating System	B
Coating Material:	Modified Polyamidoamine Epoxy and Aliphatic Acrylic Polyurethane
Surfaces:	Exposed Metal
Surface Preparation:	<ol style="list-style-type: none"> <li>1. Bare ferrous metal surfaces shall be prepared in accordance with SSPC SP-6 (Commercial Blast Cleaning).</li> <li>2. Shop primed surfaces which are to be incorporated in the work shall be prepared in the field by cleaning all surfaces in accordance with SSPC SP-2 (Hand Tool Cleaning).</li> </ol>

**Coating System****B (continued)**

3. Galvanized or nonferrous surfaces shall be treated with a passivator and vinyl wash primer as recommended by the coating system manufacturer.
4. If smoothing of rough metalwork is necessary, a smoothing cement acceptable to the paint system material manufacturer shall be used.

Application: Field

Coating System:

Primer: Tnemec Series 135 Chembuild  
One coat, 4.0 to 6.0 mils DT F  
Color: Off-White

Finish: Tnemec Series 73 Endura-Shield  
Two coats, 2.0 to 3.0 mils DFT per coat  
Color: See Paragraph 3.05

**Coating System****C**

Coating Material: 100% Solids High Build Epoxy

Surfaces: Concrete Wet Well and Manhole

Surface Preparation: Surfaces must be sound and contaminant-free with a surface profile equivalent to a minimum CSP3 to CSP5 in accordance with ICRI Technical Guideline No. 310.2R-2013. Dry abrasive sand with water blast to surface profile as recommended by the manufacturer.

Application: Field

Coating System:

Primer: As recommended by coating system manufacturer

Finish: Raven 405  
Spray apply two coats, 125 mils DFT total  
Allowed tolerances of plus 40 mils DFT to minus 0 mils DFT  
Color: Light Blue

Coating System	D
Coating Material:	Ceramic Epoxy
Surfaces:	Ductile Iron Pipe and Fittings
Surface Preparation:	As recommended by coating system manufacturer.
Application:	Factory – Interior Surfaces
Coating System:	
Primer:	As recommended by coating system manufacturer
Finish:	Protecto 401 40 mils nominal DFT Color: See Paragraph 3.05

### PART 3 : EXECUTION

#### 3.01 PREPARATION

- A. GENERAL: Surfaces to be coated shall be clean. Before applying coating or surface treatments, oil, grease, dirt, rust, loose millscale, old, weathered coatings, and other foreign substances shall be removed except as specified. Oil and grease shall be removed before mechanical cleaning is started. Where mechanical cleaning is accomplished by blast cleaning, the abrasive used shall be washed, graded, and free of contaminants that might interfere with the adhesion of the coatings.

Clean cloths and clean fluids shall be used in solvent cleaning. Cleaning and painting shall be scheduled so that dust and spray from the cleaning process will not fall on wet, newly painted surfaces.

The Contractor shall demonstrate that field coating is compatible with factory coating by applying small test patches of specified coating over shop coating. The Contractor shall pay special attention to painting of existing surfaces adjacent to the new piping and structures. Care shall be taken in surface preparation and finish work to provide a smooth transition from one surface to the other. If necessary, compatible primer shall be used when painting over existing surface.

- B. METALLIC SURFACES: Metallic surfaces shall be prepared in accordance with applicable portions of surface preparation specifications of the SSPC. Specific applicable standards are specified in each coating system. The solvent in solvent cleaning operations shall be as recommended by the manufacturer.

Preparation of metallic surfaces shall be based upon comparison with SSPC-Vis-1-67T (ASTM D220), and as described herein. To facilitate inspection, the Contractor shall, on the first day of sandblasting operations, sandblast metal panels to the standards specified. Plates shall measure a minimum of 82 inches by 11 inches. Panels meeting the requirements of the specifications shall be initialed by the Contractor and the Engineer and coated with a clear non-yellowing finish. One of these panels shall be prepared for each



type of sandblasting and shall be used as the comparison standard throughout the project.

Ductile iron pipe and fittings to be painted shall be purchased from the manufacturer without the petroleum asphalt coating normally furnished pursuant to AWWA Standards C110, C115, C151 or C153. Prepare ductile iron pipe in accordance with pipe manufacturer's recommendations and NAPP.

Surface preparation for galvanized metal, aluminum, copper, and brass shall be in accordance with SSPC SP-1 (solvent cleaning) and passivated in accordance with the coating manufacturer's written instructions.

- C. **PREPARATION OF CONCRETE, MASONRY, AND PLASTER SURFACES:** Unless otherwise specified, surfaces which are to be coated shall be allowed to age for at least 28 days and allowed to dry to the moisture content recommended by the coating manufacturer. Moisture content may be tested by the Engineer with a Delmhorst Instrument Company moisture detector or accepted equal. In addition, the surfaces shall be brush treated with a 10 percent muriatic acid solution and thoroughly flushed with water after 10 minutes. (Ten percent acid solution is commercial solution; 30 percent is diluted 2 water to 1 acid.) Loose concrete and laitance shall be removed by sandblasting and chipping, and voids and cracks shall be repaired as approved by the coating manufacturer.

Plaster surfaces shall be dry and clean and free from grit, loose plaster, and surface irregularities. Cracks and holes shall be repaired with acceptable patching materials, keyed to existing surfaces, and sandpapered smooth. Surfaces to be coated with oil or varnish base paints shall be tested for the presence of alkali. If present, the alkali shall be neutralized with acid solution as above.

Surfaces shall be cleaned with clear water by washing and scrubbing to remove foreign and deleterious substances.

- D. **PREPARATION OF PLASTIC SURFACES:** Plastic surface shall be roughened with sandpaper or steel wool and shall be cleaned with solvent compatible with specified primer.

### 3.02 APPLICATION

- A. **WORKMANSHIP:** Coated surfaces shall be free from runs, drops, ridges, waves, laps, and brush marks. Coats shall be applied so as to produce an even film of uniform thickness completely coating corners and crevices. Painting shall be performed in accordance with the requirements of SSPC Paint Application Guide.

Each coat of paint shall be applied evenly and sharply cut to line. Care shall be exercised to avoid overspraying or spattering paint on surfaces not to be coated. Glass, hardware, floors, roofs, and other adjacent areas and installations shall be protected by taping, drop cloths, or other suitable measures.

- B. **PAINT PROPERTIES, MIXING, AND THINNING:** Paint, when applied, shall provide a satisfactory film and smooth even surface, and glossy undercoats shall be lightly sanded to provide a surface suitable for the proper application and adhesion of subsequent coats. Paints shall be thoroughly stirred, strained, and kept at a uniform consistency during application. Coatings consisting of two or more components shall be mixed in accordance with the manufacturer's instructions. Where necessary to suit the conditions of the surface, temperature,

weather and method of application, the paint may be thinned immediately prior to use by the addition of not more than one pint of the proper thinner per gallon. Unless otherwise specified, paint shall not be reduced more than necessary to obtain the proper application characteristics. Thinner shall be as recommended by the coating manufacturer.

- C. **ATMOSPHERIC CONDITIONS:** Unless otherwise specified or required for certain water-thinned paints, paints shall be applied only to surfaces that are dry, and only under such combination of humidity and temperatures of the atmosphere and surfaces to be painted as well cause evaporation rather than condensation. Paint shall not be applied during rainy, misty weather, or to surfaces upon which there is frost or moisture condensation. During damp weather, when the temperature of the surface to be coated is within 10°F of the dew point, the surfaces shall be heated to prevent moisture condensation thereon. Bare metal surfaces, except those which may be warped by heat, may be dehydrated by flame-heating devices immediately prior to paint application. During painting, and for a period of at least 8 hours after the paint has been applied, the temperature of the surfaces to be painted, the painted surfaces, and the atmosphere in contact shall be maintained at or above 40°F and 10°F above the dew point. Paint, when applied, shall be approximately the same temperature as that of the surface on which it is applied. Fans or heaters shall be used inside enclosed areas where conditions causing condensation are severe.
- D. **METHOD OF PAINT APPLICATION:** Where two or more coats are required, alternate coats shall contain sufficient compatible color additive to act as indicator of coverage, or the alternate coats shall be of contrasting colors. Color additives shall not contain lead or any lead compound which may be destroyed or affected by hydrogen sulfide or any gas likely to be found in wastewater facilities.

Electrical and mechanical equipment, on which the manufacturer's coating is acceptable, shall be touch-up primed and painted with two coats of the specified coating system to match the color schedule. This does not apply to electrical and instrumentation equipment specified in Division 26 – Electrical.

Paint shall not be applied to a surface until it has been prepared as specified. Unless otherwise specified, the primer or first coat shall be applied by brush to ferrous surfaces, except subsequent coats for blast-cleaned ferrous surfaces, that may be either brush- or spray-applied. Unless otherwise specified, prime and finish coats shall be applied at the rate recommended by the manufacturer for the service involved. After the prime coat is dry, suction spots shall be touched up before succeeding coats are applied. Unless otherwise specified, coats for concrete and masonry shall be brushed or rolled.

Unless otherwise specified, finish coats shall not be applied until other work in the area is complete, and until the prime and intermediate coats have been inspected.

- E. **FILM THICKNESS AND CONTINUITY:** Coating system thickness is the total thickness of primer and finish coats and does not include passivators or sealers.

The surface area covered per gallon of paint for various types of surfaces shall

not exceed those recommended by the manufacturer. The first coat on metal surfaces refers to the first full paint coat and not to conditioning or other pretreatment applications. Unless otherwise specified, the average total thickness (dry) of any completed protective coating system on exposed metal surfaces shall be not less than 1.25 mils per coat. The minimum thickness at any point shall not deviate more than 25 percent from the required average. Unless otherwise specified, no less than two coats shall be applied.

- F. SPECIAL REQUIREMENTS: Hangers and supports shall be coated, except for the final coat, prior to installation. Except for those to be filled with grout, the underside of ungalvanized equipment bases and supports shall be coated with at least two coats of rust inhibiting primer prior to setting the equipment in place. Bolt and bolt holes in flanges (such as those used with couplings or wafer-type valves where holes and bolts as finally installed will be exposed to weather or moisture) shall be painted prior to assembly to prevent rusting of the unprotected metal.

### 3.03 CLEANUP

Upon completion of painting, the Contractor shall remove surplus materials, protective coverings, and accumulated rubbish, and thoroughly clean all surfaces and repair any overspray or other paint-related damage.

### 3.04 COATING SYSTEMS SCHEDULE

- A. In the following schedule, coating system letters shall conform to those listed in the Coating System Specification sheets.
- B. Unless shown otherwise, surface coatings shall be semigloss, except that ceilings shall be coated with flat coatings to match wall areas.
- C. Surfaces to be coated and coating systems to be used are described below. The final coat shall be applied only after all other work, including punch list items, has been completed.

Surface	Coating System
1. <u>Metal Work</u> : Equipment, including metal base and guards; conduits, piping; appurtenances, including grilles and louvers; doors; electrical, pneumatic, and instrumentation control panels and stations, including supports. Refer to equipment specifications for exceptions.	
a. Iron and steel (includes galvanized) (except non-ferrous and stainless), exposed above ground or in vault structures (not buried)	B
b. Iron piping and appurtenances	D
2. <u>Concrete, Grout, and Masonry</u> :	
a. Exterior concrete exposed slabs and surfaces	Unpainted
b. Exterior concrete buried surfaces of manholes and valve vaults	A
c. Interior concrete/grouted surfaces of wet well	C
d. Interior concrete/grouted surfaces of manholes	C
e. Interior concrete surfaces of valve and Air/Vac vault	C
3. <u>Materials Not Requiring Paint</u>	
a. Rubber, stainless steel, copper pipe, PVC pipe, and fiberglass fabrications.	—
b. Labels and Nameplates: Do not paint over Underwriters Laboratories Factory Mutual, or other code-required labels or equipment name, identification, performance rating, nomenclature plates.	—
c. Pre-Finished Items, except as damaged, including: (1) acoustic materials (2) finished mechanical and electrical equipment (3) light fixtures (4) switchgear (5) distribution cabinets (6) operating louvers	—
d. Metal Surfaces, including: (1) aluminum railing, ladders, hatlines, light poles (2) stainless steel (3) chromium plate (4) copper (5) bronze (6) brass (7) aluminized and galvanized (and vinylized) chainlink fabric fences, gates, and closures (8) Duct silencers and motor-operated dampers	—
e. Moving Parts of Operating Equipment such as the following: (1) valve and damper operators (2) linkages (3) sensing devices (4) motor and fan shafts (5) gears	—

**3.05 COLOR SCHEDULE**

The following table is a listing of colors for coatings covered in this Section and factory-applied finishes. It is intended to provide a general indication of the required color. The final color selection will be made by the Owner from the manufacturer's standard color chart provided by the Contractor. Where an exact match to other surfaces is specified, a custom-mixed color may be required.

<b>Surface</b>	<b>Color</b>
Interior Concrete Wet Well and Vaults	Light Blue
Piping, Valves, and Accessories	Light Gray

For surfaces that require coating, but no color is listed, the color shall be selected by the Owner. The Contractor shall anticipate that additional colors (standard or custom-mixed) may be required.

**END OF SECTION**

THIS PAGE INTENTIONALLY LEFT BLANK

## SECTION 22 13 00 PIPE

### PART 1 : GENERAL

#### 1.01 SUMMARY

This Section specifies pipe materials and methods and shall be used in conjunction with Section 22 13 10 – HDPE Pipe and Fittings, Section 22 13 11 – Piping Systems, and other sections of Division 22 which specify piping components.

#### 1.02 REFERENCES

All pipe materials and methods shall conform to applicable requirements of documents of latest edition listed hereafter. In case of conflict between this Section and the listed documents, the requirements of this Section shall prevail.

ANSI A13.1	Piping and Piping Systems
ANSI B16.5	Pipe Flanges and Flanged Fittings, Class 150 (Flat Face Flange)
ANSI B16.9	Factory-Made Wrought Steel Butt-Welding Fittings
ASTM A47	Malleable Iron Castings
ASTM A120	Pipe, Steel, Pipe, Black and Hot-Dip Zinc-Coated (Galvanized), Welded and Seamless for Ordinary Uses
ASTM A234	Pipe Fittings of Wrought Carbon Steel and Alloy Steel for Moderate and Elevated Temperature
ASTM A283	Low and Intermediate Tensile Strength Carbon Steel Plates
ASTM A312	Standard Specification for Seamless, Welded, and Heavily Cold Worked Austenitic Stainless Steel Pipes
ASTM A351	Standard Specification for Castings, Austenitic, for Pressure-Containing Parts
ASTM A536	Ductile Iron Castings
ASTM B32	Solder Metal
ASTM D638	Standard Test Method for Tensile Properties of Plastics
ASTM D695	Standard Test Method for Compressive Properties of Rigid Plastics
ASTM D1248	Standard Specification for Polyethylene Plastics Extrusion Materials for Wire and Cable
ASTM D1784	Rigid Polyvinyl Chloride (PVC) Compounds and Chlorinated Polyvinyl Chloride (CPVC) Compounds
ASTM D1785	Polyvinyl Chloride (PVC) Plastic Pipe, Schedules 40, 80, and 120

ASTM D2467	Socket-type Polyvinyl Chloride (PVC) Plastic Pipe Fittings, Schedule 80
ASTM D2564	Solvent Cements for Polyvinyl Chlorine (PVC) Plastic Pipe and Fittings
ASTM D2837	Standard Test Method for Obtaining Hydrostatic Design Basis for Thermoplastic Pipe Materials or Pressure Design Basis for Thermoplastic Pipe Products
ASTM D3034	Polyvinyl Chloride (PVC) Sewer Pipe and Fittings
ASTM D3261	Standard Specification for Butt Heat Fusion Polyethylene (PE) Plastic Fittings for Polyethylene (PE) Plastic Pipe and Tubing
ASTM D3350	Standard Specification for Polyethylene Plastics Pipe and Fittings Materials
ASTM F477	Elastomeric Seals (Gaskets) for Joining Plastic Pipe
ASTM F714	Standard Specification for Polyethylene (PE) Plastic Pipe (SDR-PR) Based on Outside Diameter
ASTM F1055	Standard Specification for Electrofusion Type Polyethylene Fittings for Outside Diameter Controlled Polyethylene Pipe and Tubing
ASTM F2164	Standard Practice for Field Leak Testing of Polyethylene (PE) and Crosslinked Polyethylene (PEX) Pressure Piping Systems Using Hydrostatic Pressure
ANSI/AWWA C110/A21.10	Standard for Ductile Iron and Gray Iron Fittings, 3-inch through 48-inch, for Water and Other Liquids
ANSI/AWWA C111/A21.11	Standard for Rubber Gasket Joints for Ductile Iron and Gray Iron Pressure Pipe and Fittings
ANSI/AWWA C115/A21.15	Standard for Flanged Ductile Iron Pipe with Threaded Flanges
ANSI/AWWA C150/A21.50	Standard for Thickness Design of Ductile Pipe
ANSI/AWWA C151/A21.51	Standard for Ductile Iron Pipe, Centrifugally cast, in Metal Molds or Sand Lined Molds for Water and Other Liquids
UPC	Uniform Plumbing Code (latest edition)
Standard Specifications - 2021 WSDOT Standard Specifications for Road, Bridge, and Municipal Construction.	



**1.03 SUBMITTALS**

- A. In accordance with the requirements of Section 1-06 – Control of Materials, submit the following:
1. Manufacturer's technical data for all piping, and documentation of conformance with appropriate standards and these specifications.
  2. Detailed drawings of all interior piping requirements, prepared in conformance with the following:
    - a. Plan drawings shall be prepared for all areas involving piping and equipment at a scale not less than 1-inch equals 1 foot. Plan drawings shall be prepared for all work areas that contain new piping. Sections shall be cut as required to clearly show piping in each of the plan drawings.
    - b. Drawings shall be dimensioned to show the location of all new piping, pipe joints, pipe supports, pipe penetrations, valve end connections, and all other piping appurtenances.
    - c. Drawings shall clearly show the methods of pipe joint connections, pipe support, pipe penetrations, valve end connections, and all other piping appurtenances.
    - d. Piping support structural requirements, calculations, manufacturers, spacing, and detailed drawings as required to establish that the proposed piping support and restraints meet the requirements of the specifications, drawings, and piping manufacturer.
    - e. Drawings shall show structural and mechanical components of the piping systems separately if required for clarity.
    - f. Drawings shall indicate field verified elevations/dimensions for existing facilities and connections, in addition to any dimensions identified on the Drawings.
  3. Pressure Testing Plan.
  4. Test Results.

**1.04 QUALITY CONTROL**

- A. The Contractor shall utilize quality control procedures acceptable to the Engineer and the Owner for the following:
1. Inspection of pipe before installation.
  2. Pipe unloading, storage, installation, and jointing.
- B. Tests performed by the Contractor shall include, but not be limited to, the following:
1. Hydrostatic Pressure Test.
  2. Air Pressure Test.

**PART 2 : PRODUCTS****2.01 GENERAL**

- A. Materials required for all piping and connections shall be as specified herein and in Section 22 13 10 – HDPE Pipe and Fittings and Section 22 13 11 – Piping Systems. All pipe sizes shall be as shown on the Drawings.
- B. All pipe sizes as shown on the Drawings and as specified herein are in reference to “nominal” diameter, unless otherwise indicated.
- C. The piping systems shown on the Drawings indicate the appropriate horizontal and vertical configuration required. The Contractor shall determine the exact layout of piping, fittings, and joints necessary to fit actual field conditions.
- D. Gasket type or material used shall be appropriate for each pipe system and service intended, and shall be as specified in Section 22 13 10 – HDPE Pipe and Fittings and Section 22 13 11 – Piping Systems.

**PART 3 : EXECUTION****3.01 GENERAL**

- A. **LOCATION:** The Contractor shall be responsible for checking and verification of all existing piping and appurtenances whether or not they are shown on the Drawings. The Contractor shall excavate and locate all existing pipes, appurtenances, and points of connection. The Contractor shall check and verify or modify horizontal and vertical locations of each and every exposed piping run, with Engineer approval. The Contractor shall be responsible for the protection of all existing piping, appurtenances, and structures during construction and shall take care not to damage them or impair the operation in any way.
- B. **PIPING SIZES:** Where the size of piping is not specified, the Contractor shall provide piping of the sizes required by UPC. Unless specified otherwise, small piping (less than 1 inch in diameter) required for service not described by UPC shall be ½ inch.
- C. **PIPE SUPPORTS:** Piping hangers and structural attachments shall be as specified in Section 22 13 13 – Pipe Support Systems and shall be designed in conjunction with pipe to be supported and shall be installed in accordance with the approved submittal design and drawings. The Contractor shall install piping support such that line and grade requirements are satisfied.
- D. **RESTRAINT:** Piping under pressure shall be restrained at all bends, wyes, tees, pipe joints and couplings, unless otherwise indicated.
- E. **LINE AND GRADE DEVIATIONS**
  - 1. Buried, Bedded, and Encased Pipe. Variance from required line shall not exceed ½ inch. Variance from grade shall be in accordance with Section 7-08.3(2)B of the Standard Specifications.

2. Exposed Pipe. Variance from required line and grade shall not be greater than  $\frac{1}{4}$  inch. All pipe shall be laid in straight runs with fittings as required for bends. Gravity flow pipe shall be laid at constant slope.
- F. BURIED PIPE LAYING: Preparation of bedding and backfill shall be as specified in Section 31 23 33 – Trenching, Backfilling, and Compacting for Utilities and as indicated on the Drawings. Pipe shall be laid with uniform bearing under the full length of the barrel of the pipe.
- G. PIPE PENETRATIONS: Pipe penetrations into structures shall be as shown on the Drawings.
- H. ELECTRICAL ISOLATION: All connections between dissimilar metal pipe, such as copper or bronze to steel, coated to uncoated metallic piping, or piping with different types of coatings, shall be electrically isolated with an electrically insulating fitting. Fittings shall be unions, couplings, or flange sets for the service intended unless specified otherwise.
- I. INSULATING FITTINGS: All metallic piping shall be isolated from all structures with appropriate insulating flanges, insulating flexible couplings, or insulating unions. New pipe shall be isolated from existing piping. Pipe at transitions from concrete encasement to soil shall be provided with insulating fittings.

Insulating fittings shall be placed at transitions between pipelines with dissimilar coatings.

### 3.02 TESTING

- A. PIPE PRESSURE TESTING: Pipe shall be pressure tested to the test pressure indicated in Section 22 13 11 – Piping Systems. Hydrostatic pressure testing shall be in accordance with ASTM F2164 and as specified herein. Low pressure air testing shall be in accordance with Section 7-17.3(2)F of the Standard Specifications and as specified herein. Pressure testing shall be in accordance with the Uniform Plumbing Code and NFPA where indicated in Section 22 13 11 – Piping Systems.
  1. The Contractor shall submit a Pressure Testing Plan to the Engineer for review and approval prior to testing for all pipe to be tested. The Plan shall include a narrative description of the test identifying all equipment used, temporary piping arrangements, test pressure and duration, testing schedule, testing water source location and backflow device, water disposal location and techniques, and what sections of pipe will be tested in what order.
  2. TEST RESULTS: Submit Test Results for all pressure testing.
  3. The Contractor is responsible for conveying the water used for testing. Water for testing will be supplied by the Owner. Raw sewage shall not be used as the testing media.
  4. Contractor shall perform all tests specified. Provide all test equipment including test pumps, gauges, volumetric measuring equipment, and other equipment required. Pressure gauges used shall be graduated in increments not greater than 5 psi and shall have a range of approximately twice test pressure. Use only gauges and instruments recently calibrated.

5. Completed installation shall comply with designated requirements. Provide replacement materials as may be required to accomplish this compliance.
  6. Remove from systems, during testing, all equipment which would be damaged by test pressure. Replace removed equipment after testing. Systems may be tested in sections as work progresses; however, any previously tested portion shall become a part of any later test of composite system. Where new pipe connects to existing piping, the joint between the two pipes shall be tested. Correct leaks by remaking joints with new material; makeshift remedies will not be permitted. Test time will be accrued only while full test pressure is applied to system.
  7. The Contractor shall be responsible for providing all temporary fittings, plugs, and thrust blocking for all testing at the specified pressure.
  8. Perform all testing before backfilling, concealing, insulating, or painting.
  9. CORRECTION: Each section of pipeline which fails the pressure test and connection pipe and fittings that are observed to leak shall be removed and either properly reinstalled, or replaced with new materials. Reinstalled and replaced pipeline sections shall be pressure tested after completion of backfilling.
  10. VALVES: Test valve bonnets for tightness. Test operate valves from closed-to-open-to-closed positions while valve is under piping pressure. Test automatic valves by actuating from fully open to fully closed position.
- B. HANGERS AND SUPPORTS: With systems in normal operation, test hangers, supports, and rods to ensure they are plumb and support proper share of load. Additionally support, as required, systems and equipment that sway, crawl, and vibrate.
- C. OTHER MATERIALS AND EQUIPMENT: Test other materials and equipment as specified, as recommended by equipment manufacturer, or directed to assure they are complete, operable, and ready for use.

### 3.03 CLEANING

- A. Clean equipment and materials. Remove foreign materials including dirt, grease, and other matter.
- B. Clean by flushing interior of wastewater piping with water after pressure testing.

**END OF SECTION**

## **SECTION 22 13 10 HDPE PIPE AND FITTINGS**

### **PART 1 : GENERAL**

#### **1.01 DESCRIPTION OF WORK**

- A. High Density Polyethylene (HDPE) pipe and fittings used for conveying wastewater from Pump Stations 17, 24, 64, and 67, as depicted in the Drawings.

#### **1.02 SUBMITTALS**

- A. Submit in accordance with the requirements of Section 1-06 – Control of Materials.
- B. Prior to shipping any material to the site, submit the following:
  - 1. Manufacturer's product data including pipe, pipe accessories, and appurtenances. Provide manufacturers certificates for materials that meet or exceed these Specifications.
  - 2. Detail drawings and product data showing pipe joint connections and couplings, to confirm compatibility of joining systems.
- C. Prior to installation of any components, submit the following:
  - 1. Pipe installer's qualifications.
  - 2. Plan(s) showing pipe installation sequence and schedule.
- D. Testing:
  - 1. Flushing/Pigging Plan.
  - 2. Pressure Testing Plan.
  - 3. Test Results.

#### **1.03 QUALITY ASSURANCE**

- A. Referenced Standards: This Section incorporates by reference the latest revision of the following documents. It is part of this Section as specified and modified. In case of conflict between the requirements of this Section and that of the listed documents, the requirements of this Section shall prevail.
  - 1. American Society for Testing and Materials (ASTM):
    - a. D638: Standard Test Method for Tensile Properties of Plastics.
    - b. D695: Standard Test Method for Compressive Properties of Rigid Plastics.
    - c. D2837: Standard Test Method for Obtaining Hydrostatic Design Basis for Thermoplastic Pipe Materials or Pressure Design Basis for Thermoplastic Pipe Products.

- d. D3261: Standard Specification for Butt Heat Fusion Polyethylene (PE) Plastic Fittings for Polyethylene (PE) Plastic Pipe and Tubing.
- e. D3350: Standard Specification for Polyethylene Plastics Pipe and Fittings Materials.
- f. F477: Standard Specification for Elastomeric Seals (Gaskets) for Joining Plastic Pipe.
- g. F714: Standard Specification for Polyethylene (PE) Plastic Pipe (SDR-PR) Based on Outside Diameter.
- h. F1055: Standard Specification for Electrofusion Type Polyethylene Fittings for Outside Diameter Controlled Polyethylene Pipe and Tubing.
- i. F2164: Standard Practice for Field Leak Testing of Polyethylene (PE) and Crosslinked Polyethylene (PEX) Pressure Piping Systems Using Hydrostatic Pressure.

#### 1.04 DELIVERY, STORAGE AND HANDLING

- A. Labeling: The following information shall be continuously marked on the pipe and spaced at intervals not to exceed 5 feet:
  - 1. Name and/or trademark of the pipe manufacturer.
  - 2. Nominal pipe size.
  - 3. Standard Dimensional Ratio (SDR)/Schedule.
  - 4. Material Classification.
  - 5. Manufacturing Standard Reference.
  - 6. A production code from which the date and place of manufacture can be determined.
- B. Transportation is the responsibility of the Contractor, who shall be liable for all damages prior to and during transportation to site.
- C. During shipment and storage, the pipe shall be wrapped in relatively impermeable and opaque protective covers.
- D. Inspect materials delivered to the site for damage. Unload and store with minimum of handling. Store the pipe and fittings in a flat, horizontal position. Do not sort materials directly on the ground. Keep inside of piping free of dirt and debris.
- E. Handling, storage, and care on-site are the responsibility of the Contractor prior to, during and after installation. Handle pipes, fittings, and other accessories in a manner that ensures delivery to the point of installation in sound, undamaged condition. Do not drop pipe. Carry, do not drag, pipe to the point of installation.

#### 1.05 QUALIFICATIONS

- A. The pipe installer shall be qualified by experience in installation of HDPE pipe.

- B. Joining pipe by butt-fusion welding shall be conducted according to manufacturer's recommendation by a person/persons certified as capable of conducting butt-fusion techniques for the pipe size being fused by the pipe manufacturer or manufacturer's authorized representative.
- C. Contractors are considered qualified by installing a minimum combined total of 15,000 feet of HDPE pipe using thermal fusion joining on at least 3 separate projects.

## PART 2 : PRODUCTS

### 2.01 PIPING SYSTEMS

- A. HDPE pipe and/or fittings include:

Piping Description	Nominal Diameter	DR	Pressure Rating	ASTM D3350 Cell Classification
Force Main	See Drawings, Iron Pipe Size (IPS)	11	200 psi	445474

### 2.02 MATERIAL

- A. HDPE pipe and fittings shall be extruded from PE 4710, high-density polyethylene compound conforming to ASTM D3350 for a PE 4710 material with a cell classification as shown in the table above or better. This material shall have a minimum long-term hydrostatic strength of 1600 psi when tested and analyzed by ASTM D2837.
- B. The polyethylene compound shall be suitably protected against degradation by ultraviolet light by means of carbon black, well dispersed by precompounding in a concentration of not less than 2 percent.
- C. The manufacturer's resin used to manufacture the pipe and fittings for this project shall be listed with the Plastic Pipe Institute TR-4 by company name and material designation as meeting the standard requirements for PE 4710 material.
- D. HDPE products shall contain no recycled compounds except that generated in the manufacturer's own plant from resin of the same specifications from the same raw material supplier.

### 2.03 HIGH DENSITY POLYETHYLENE (HDPE) FITTINGS

- A. Molded or fabricated from HDPE pipe shall have the same or numerically smaller SDR than pipe connecting to the fitting. HDPE fittings shall be molded, for sizes 8-inch and smaller, if manufactured as a standard item. All other HDPE fittings shall be fabricated from HDPE pipe by means of thermal butt-fusion unless otherwise noted.

- B. All molded HDPE fittings shall have the same or higher pressure rating as the pipe when installed in accordance with the latest technical specifications. All fabricated HDPE fittings shall have the same or higher pressure rating as the adjoining pipe when installed in accordance with the manufacturer's recommendations.

#### **2.04 PIPE CONNECTIONS**

Joints and pipe connections shall be thermal butt-fusion. No mechanical couplings shall be used unless approved by the Engineer or shown on the Drawings.

#### **2.05 FLANGE ADAPTERS**

Flange adapters shall be a complete one-piece, polyethylene molded adapter provided with a flange backup ring. Flange backup rings shall be 304 stainless steel with 150-pound, ANSI B16.5 standard dimensions unless specified otherwise. Flanged connections shall have the same or greater pressure rating as the pipe. All fasteners shall be 316 stainless steel and shall be assembled with anti-seize compound as recommended by the manufacturer. Gaskets shall be installed at all flanged connections.

#### **2.06 GASKETS**

- A. Gaskets shall be required between HDPE flanged fittings and ductile or cast flanged fittings on appurtenances.
- B. Gaskets shall be full face, flat ring, 1/8-inch material. Gaskets for wastewater service shall be Grade "M" halogenated butyl and conform to ASTM F477 Elastomeric Seals (Gaskets) for Joining Plastic Pipe.
- C. Gaskets shall be installed per manufacturer's requirements.

#### **2.07 HARDWARE**

Bolts, nuts, washers, and miscellaneous hardware shall be 304 stainless steel unless noted otherwise on the Drawings or in these Specifications. All hardware shall be assembled with anti-seize compound as recommended by the manufacturer.

### **PART 3 : EXECUTION**

#### **3.01 GENERAL**

- A. Install HDPE pipe and fittings at the locations, lines and grades shown on the Drawings. All HDPE pipe and fittings shall be installed in accordance with these Specifications and manufacturer's recommendations.
- B. Materials and Work which fail to meet the requirements of these Specifications shall be removed and disposed of at the Contractor's expense.



**3.02 ALLOWANCE FOR THERMAL EXPANSION/CONTRACTION**

- A. PE 4710 material has a coefficient of thermal expansion of  $8 \times 10^{-5}$  in/in/deg F; Contractor to verify recommended coefficient of thermal expansion with pipe manufacturer.
- B. Determine installation length of pipe based on site temperature and conditions. Contractor to install piping as shown on the Drawings and shall provide Engineer with any calculations for installation lengths per the following constraints:
  - 1. Buried HDPE pipe shall be installed such that contraction between fittings/anchor points caused by temperatures dropping to 50 degrees F will produce the theoretical length of pipe between two points as shown on the Drawings while neglecting frictional forces.
- C. Final connections to fittings/anchor points shall be made after the pipe has equilibrated to its operating temperature.

**3.03 PLACEMENT AND HANDLING**

- A. Handle all materials in such a manner as to ensure it is not damaged in any way.
- B. Pipe shall be marked with the manufacturer's name, product identification, lot number, roll number, and roll dimensions.
- C. The Engineer will examine the piping over the entire surface to ensure that no potentially harmful foreign objects are present. Any foreign objects so encountered shall be removed by the Contractor, or material shall be replaced.

**3.04 CONFORMANCE TESTING**

- A. Samples of materials delivered to site may be collected for testing to verify conformance with properties in Part 2 of this Specification, at Engineer's discretion.
- B. Samples, if required, will be obtained by the Engineer. All testing performed will be paid for by the Contractor.

**3.05 PIPE JOINING**

- A. All joints shall be butt fused except for those indicated per the drawings. Butt fused joints shall have a joint weld strength equal to or greater than the tensile strength of the pipe itself. Flange adapters butt fused to the pipe shall be provided where indicated on the Drawings. No other types of joints or joint restraint devices will be allowed unless specifically shown on the Drawings or specified herein.
- B. Flanges:
  - 1. Bolts on flanges shall be tightened in a pattern sequence to the torque value recommended by the pipe and/or flange adapter manufacturer. A torque wrench shall be used to tighten all bolts and nuts. Bolts shall be retightened twice thereafter as follows:

- a. One (1) to two (2) hours initial tightening and
  - b. Four (4) to six (6) hours after the initial tightening.
2. Flanges shall be marked with an indelible marker to indicate the number and time of each tightening.
- C. Field Fusion:
1. Fusing/joining pipe in the trench will not be allowed except for electrofusion of pipe as indicated on the Drawings. A tent/shelter that is specifically made for field fusion operations shall be set up over the joining operation at all times to minimize contamination and heat loss, as well as protect the operation during inclement weather. A suitable base board or ground sheet shall be set underneath the tent/shelter.
  2. All connections shall be clean, dry, and free of detrimental surface defects before the connection is made. General dust and light soil may be removed by wiping the surfaces with clean, untreated, dry, lint-free, non-synthetic cloths. Heavier soil shall be washed or scrubbed off with soap and water solution, followed by a thorough rinsing with clean, clear water, and drying with clean, untreated, dry, lint-free, non-synthetic cloths. Chemical solvents are not to be used as they may leave a residue or be incompatible with HDPE.
  3. Use handsaws and chain saws for cutting pipe. Chain saws shall be used without chain lubrication because of the potential for chain oil contamination.
  4. The following procedures and requirements for joining/fusion of pipe are based on PPI's, Performance Pipe and WL Plastics pipe joining procedures and requirements. The butt fusion equipment and pipe manufacturer's more detailed instructions shall be used and followed. The stricter procedures and requirements shall be used and followed. Pipe manufacture shall provide a letter to Engineer of any differences of concern between these specifications and the pipe manufacturer's recommended procedures or requirements. Deviations to these specifications will be subject to the approval of the Engineer.
- D. Fusion Machine Preparation:
1. Wash the heater plate when cold before every welding session. Never use chemicals, metal, or abrasive implements to clean heating tool. Burned or charred material shall be removed in accordance with the equipment manufacturer's written instructions.
  2. Using the equipment manufacturer's instructions, calculate and verify that the fusion machine hydraulic fusion joining pressure gauge setting is such that it is within the recommended interface pressure range.
  3. Verify the heating tool is at and maintaining correct temperature. Monitor the heating tool surface with a calibrated, pyrometer or an infrared temperature gauge to ensure proper temperature (heating tool thermometers will typically be higher than surface temperature). Verify that all points on both heating tool surfaces where the surfaces will contact the pipe are within the recommended range.

- E. Fusion Equipment. Pipe shall be properly supported on either side of the Secure and Support: Properly align and secure the components in the butt equipment such that the pipes are aligned straight to each other at the fusion joint.
- F. Face: Face ends of pipe to establish smooth, clean parallel mating surfaces. Remove shavings with a clean, untreated, dry, lint free, non-synthetic cloth. Do not touch the component ends with hands after facing.
- G. Align: Bring the component ends together, check alignment, and check for slippage. Look for complete contact all around both ends with no detectable gaps.
- H. Melt: Prior to pipe joining, heating tool surfaces must be clean, and heating tool surfaces must be up to the specified minimum recommended temperature (400° F), but not above the maximum recommended temperature (450° F). Optimum temperature is 425° F. Immediately after heating tool removal, quickly inspect (within 3 seconds) both component ends for proper melt surfaces. They should appear flat, smooth, and be completely melted. Unacceptable melt is any combination of a concave (cupped), bubbly or pock-marked sandpaper like melt surface, or unmelted areas or melted material sticking to heating tool surface. Do not continue with making the joint if these conditions are observed as low strength joints result from improper melt surfaces. Allow melted ends to cool and remake the joint from the beginning.
- I. Join:
  - 1. If acceptable melt is observed, immediately bring component ends together to ensure full contact.
  - 2. Apply and hold joining force against the melted ends until the joint cools and solidifies. Observe the melt bead roll as the component ends are joined and the joining force is applied. The correct joining force will form a double bead that is rolled over to the surface on both ends. When the proper melt bead size of 7/16 inch is formed, quickly and smoothly separate the ends, and remove the heating tool.
  - 3. The joint must be kept under pressure until the joint has cooled sufficiently. While maintaining pressure, allow joint to cool under ambient conditions. Do not use forced air, water, or wet cloths to expedite cooling of the joint. Proper cooling times (under pressure) are dependent on pipe diameter, wall thickness, heater plate temperature and environmental conditions. Estimated cooling time as determined by the pipe manufacturer shall be adhered to at all times to ensure joint integrity. The pipe manufacturer's cooling times are estimates, however, and should therefore be considered as only a guideline. Adjustment to these times will likely be needed. A pyrometer shall be used to check the bead temperature. If the temperature is about the same as that of the pipe, the joint has cooled enough for gentle handling (i.e., removal of the joint/ pipe from the machine to start another joint). Additional time (30 minutes or more) is required for the joint to cool completely through, and until such additional time has elapsed, the pipe shall not be subject to rough handling or bending.

- J. Interior Bead Removal: Remove Interior Bead to create a smooth interior pipe surface at each joint.
- K. Inspect:
1. On both sides, the double bead should be rolled over to the surface and be uniformly rounded and consistent in size and shape all around the joint. The combined width of the beads should be 2 to 2-1/2 times the height above the surface. The V-groove between the beads should not be deeper than half the bead height above the component OD surface. Use a bead gauge to check that bead width conforms to specifications. Enter information on joint checklist and data form. Number/code the joint using an indelible marker. Print out data from data logger/controller and verify compliance. Complete joint checklist and data form.
  2. The Engineer will periodically check and monitor the joint/fusion process but will not observe all joints that are made. Joints that are made on any given day will be reviewed, approved, or rejected by the Owner's Representative that same day or the next day. Review of joints is subject to the Owner's Representative being provided with the data logger joint information and joint checklist and data forms on each joint and sufficient time to review the information prior to making a visual inspection of the joints. Pipe/joints shall be elevated and placed such that Owner's Representative can easily and readily review the entire joint. Under no circumstances shall pipe be installed without the Owner's Representative's review of the joints. Pipe that is installed without such review may be required to be removed or exposed for inspection.
- L. Rejected Joints:
1. The following will be the basis and grounds for rejecting joints. Joints that are rejected will be cut out and remade from the beginning.
    - a. Beads not rolled over to the surface.
    - b. Flat beads.
    - c. Non-uniform or irregular bead size or shape.
    - d. Bead widths less than specified minimum.
    - e. V-grooves deeper than specified.
    - f. Misaligned joints (greater than 10 percent wall offset).
    - g. Differences in trial data logger trace that indicate poor quality fusion.

### 3.06 MECHANICAL CONNECTIONS

- A. Mechanical connections of the polyethylene pipe to auxiliary equipment, such as valves and other piping systems, shall be through flanged connections that shall consist of the following:
1. A polyethylene molded flange adapter shall be thermally butt-fused to the ends of the pipe.

2. Backup rings, as specified in this Section, shall be used behind the flange adapter.
  3. Fasteners shall be of sufficient length to show a minimum of three complete threads when the joint is made and tightened to the manufacturer's standard. The Contractor shall re-torque the nuts after 4 hours.
- B. Assembly: Prior to connecting flanged pipe, the faces of the flanges shall be thoroughly cleaned of all oil, grease, and foreign material. The gaskets shall be thoroughly cleaned and checked for proper fit. Care shall be taken to ensure proper seating of the flange gasket. All bolted connections shall be tightened with a torque wrench and bolts shall be tightened to the torque specified by the manufacturer of the HDPE flanges and/or backing rings and/or gaskets. Follow the manufacturer's specified bolt-tightening sequence. Bolts may be pre-tightened using conventional wrenches and/or air tools as long as the pre-tightening torque does not exceed approximately 50 percent of the final torque and the bolt-tightening sequence is followed. Do not attempt to flange up a pipeline that is too short by drawing the bolts together. If joints leak when the hydrostatic pressure test is applied, the gaskets shall be removed and reset and bolts re-tightened.

### 3.07 ELECTROFUSION FITTINGS

Electrofusion fittings shall be installed in strict conformance with manufacturer's instructions. All required equipment, manufacturer-recommended regulator and generator shall be provided by the Contractor. Workmen shall be trained in the installation, and the welding procedure shall be reviewed with the Engineer prior to start of work.

### 3.08 CLEANING

- A. Prior to testing, pipelines shall be cleaned to remove shavings, welding slag, dirt, construction debris, and other foreign material.
- B. Clean HDPE force main by inserting and flushing cleaning pigs through the force main until the flushing water is clean and accepted by the Owner. Owner shall witness the cleaning operations.
- C. If HDPE force main is temporarily used during construction to convey wastewater flow, the force main shall be pigged a second time prior to operation of the new force main.
- D. Perform flushing/pigging of pipelines in accordance with the manufacturer's recommendations. The Contractor shall submit valid certification of training for at least one person to be onsite during flushing issued by an established pig manufacturer. Pigs shall be selected and installed as recommended by the manufacturer based on the pipe material, configuration, and pressure rating of the force main. Pigs shall be provided by Girard Industries or accepted equal.

- E. The Contractor shall submit a Flushing/Pigging Plan to the Engineer for review and approval prior to cleaning. The Plan shall include a narrative description of the flushing/pigging operation identifying all equipment used, certification of training, temporary piping arrangements, flushing pressures, testing water source location and backflow device, water disposal location and techniques, cleaning schedule, and what sections of pipe will be flushed/pigged in what order.
- F. Hoses, temporary piping and valving, ditches, etc., as required to conduct pigging operations and dispose of flushing water without damage to adjacent properties is the Contractor's responsibility and to be provided at no additional cost to Owner.
- G. Submit results/completion of flushing/pigging.

**3.09 PRESSURE TESTING**

Pressure testing and acceptance shall be conducted in accordance with ASTM F2164. The HDPE shall be filled with water, raised to the test pressure specified in Section 22 13 11 – Piping Systems and allowed to stabilize. The Contractor shall submit a Pressure Testing Plan and Test Results in accordance with Section 22 13 00 – Pipe.

**END OF SECTION**

# SECTION 22 13 11 PIPING SYSTEMS

## PART 1 : GENERAL

### 1.01 SUMMARY

This Section describes the requirements for each of the piping systems included in the work. Each of the forms at the end of the Section describes a separate piping system, including the following: service; piping color; pipe identification legend; piping system abbreviation; gaskets; testing requirements; service pressure; service temperature; and pipe, fitting, and valve specifications for each pipe size required.

### 1.02 REFERENCES

- A. As indicated in Section 22 13 00 – Pipe.
- B. Standard Specifications - 2021 WSDOT Standard Specifications for Road, Bridge, and Municipal Construction.

### 1.03 GENERAL REQUIREMENTS

All pipe and fittings shall be in accordance with the requirements of Section 22 13 00 – Pipe, and as specified herein. All piping appurtenances shall be in accordance with the requirements of Section 22 13 19 – Pipe Appurtenances. All valves shall be in accordance with the requirements of Section 22 13 15 – Valves Basic Requirements and individual valve sections.

## PART 2 : PRODUCTS

### 2.01 PIPING SYSTEMS

Each piping system shall be composed of the pipe, piping appurtenances, and/or valves specified by the forms included hereinafter. The forms are included by the abbreviations shown on the Drawings and as follows:

System Abbreviation	System
V	Vent
* See Division 23 for requirements.	

PIPING SYSTEM SPECIFICATIONS				
<b>System</b> Vent		<b>Background Color</b> —		<b>Legend</b> —
<b>Gasket:</b> As specified		<b>Test Medium:</b> <input checked="" type="checkbox"/> Air <input checked="" type="checkbox"/> Water		<b>Abbreviations</b> V
<b>Pressure — PSIG</b>			<b>Temperature — °F</b>	
Work: <u>N/A</u> —		Max: <u>N/A</u> —	Test: *	Normal: <u>65</u>
Max: <u>85</u>				
Pipe Size	Exposure	Item	Description	
All	BURIED/ EXPOSED – as indicated on the drawings	Pipe	PVC: Schedule 80, Type I, Grade I or Class 12454-B conforming to ASTM D1784 and ASTM D1785. Threaded Nipples: Schedule 80 PVC.	
		Lining	None.	
		Coating	None.	
		Fittings	PVC: Schedule 80 as specified under Pipe above, ASTM D2466 and ASTM D2467 for socket-weld type and ASTM D2464 for threaded type.	
		Joints	PVC: Solvent socket-weld, except where connection to valves and equipment may require future disassembly.	
		Couplings	As indicated on the Drawings and specified in Section 22 13 19 – Pipe Appurtenances.	
		Gaskets	PVC: As recommended by the pipe and fitting manufacturer conforming to ASTM D2564.	
		Joint Lubricant	PVC: Teflon tape for threaded joints.	
<b>Remarks:</b> *in accordance with the Uniform Plumbing Code.				

PIPING SYSTEM SPECIFICATIONS				
<b>System</b> Vent		<b>Background Color</b> —		<b>Legend</b> —
<b>Gasket:</b> As specified		<b>Test Medium:</b> <input checked="" type="checkbox"/> Air <input checked="" type="checkbox"/> Water		<b>Abbreviations</b> V
<b>Pressure — PSIG</b>			<b>Temperature — °F</b>	
Work: <u>N/A</u> —		Max: <u>N/A</u> —	Test: *	Normal: <u>65</u>
Max: <u>85</u>				
Pipe Size	Exposure	Item	Description	
All	BURIED/ EXPOSED – as indicated on the drawings	Pipe	PVC: Schedule 40, Type I, Grade I or Class 12454-B conforming to ASTM D1784 and ASTM D1785. Threaded Nipples: Schedule 40 PVC.	



PIPING SYSTEM SPECIFICATIONS				
<b>System</b> Vent		<b>Background Color</b> —		<b>Legend</b> —
<b>Gasket:</b> As specified		<b>Test Medium:</b> <input type="checkbox"/> Air <input type="checkbox"/> Water		<b>Duration:</b> * Min
<b>Pressure — PSIG</b>			<b>Temperature — °F</b>	
Work: <u>N/A</u> —	Max: <u>N/A</u> —	Test: *	Normal: <u>65</u>	Max: <u>85</u>
Pipe Size	Exposure	Item	Description	
		Lining	None.	
		Coating	None.	
		Fittings	<u>PVC</u> : Schedule 40 as specified under Pipe above, ASTM D2466 and ASTM D2467 for socket-weld type and ASTM D2464 for threaded type.	
		Joints	<u>PVC</u> : Solvent socket-weld, except where connection to valves and equipment may require future disassembly.	
		Couplings	As indicated on the Drawings and specified in Section 22 13 19 – Pipe Appurtenances.	
		Gaskets	<u>PVC</u> : As recommended by the pipe and fitting manufacturer conforming to ASTM D2564.	
		Joint Lubricant	<u>PVC</u> : Teflon tape for threaded joints.	
<b>Remarks:</b> *in accordance with the Uniform Plumbing Code.				

**END OF SECTION**

THIS PAGE INTENTIONALLY LEFT BLANK

**SECTION 22 13 12**  
**DUCTILE IRON PIPE, FITTINGS AND SPECIAL ITEMS**

**PART 1 : GENERAL**

**1.01 DESCRIPTION**

Work under this Section applies to the furnishing and installation of ductile iron pipe, fittings and special items for wastewater service. The CONTRACTOR shall furnish and install ductile iron pipe, fittings, valves, special items and all appurtenant work, complete in place, all in accordance with the requirements of the Contract Documents.

**1.02 REFERENCE SPECIFICATIONS, CODES, AND STANDARDS**

ASME/ANSI B16.1	Cast Iron Pipe Flanges and Flanged Fittings, Class 25, 125, 250, and 800
ANSI/NSF Standard 61	Listed Drinking Water System Components - Health Effects
ASTM A 126	Specification for Gray Iron Castings for Valves, Flanges, and Pipe Fittings
ANSI/AWWA C104/A21.4	Cement-Mortar Lining for Ductile-Iron Pipe and Fittings for Water
AWWA C105	Polyethylene Encasement for Ductile- Iron Pipe Systems
ANSI/AWWA C110/21.10	Ductile-Iron and Gray-Iron Fittings, 3- Inch Through 48- inch for Water and Other Liquids
ANSI/AWWA C111/A21.11	Rubber-Gasket Joints for Ductile-Iron Pressure Pipe and Fittings
ANSI/AWWA C115/A21.15	Flanged Ductile-Iron Pipe with Threaded Flanges
ANSI/AWWA C150/A21.50	Thickness Design of Ductile-Iron Pipe
ANSI/AWWA C151/A21.51	Ductile-Iron Pipe, Centrifugally Cast, for Water and Other Liquids
ANSI/AWWA C153/A21.53	Ductile-Iron Compact Fittings, 3-inch through 16-inch, for Water and Other Liquids
AWWA C600	Installation of Ductile-Iron Water Mains and Their Appurtenances

**1.03 SUBMITTALS**

- A. See Section 01300 – Contractor Submittals for submittal procedures.
- B. Product technical data and material data; including all pipe, fitting, restrained joint system, lining and appurtenance information.
- C. Lining and coating data.
- D. Applicable material certifications and testing certificates.
- E. Manufacturer’s handling delivery storage and installation requirements.

**1.04 QUALITY ASSURANCE**

- A. Unless otherwise noted, all materials provided for the project shall be of first class quality and shall be made by reputable manufacturers. All material of a like kind shall be provided from a single manufacturer unless otherwise approved by the PROJECT REPRESENTATIVE. All material shall be carefully handled and installed in good working order free from defect in manufacture, storage and handling. Where an item is to be used but does not have its quality specified herein, it shall be equal to that specified in the appropriate American Water Works Association (AWWA) Standard Specification.
- B. All references to standards of AWWA or other organizations shall be the latest version of those standards.

**PART 2 : PRODUCTS**

**2.01 GENERAL**

- A. Ductile iron piping materials and specials shall meet the specifications of this Section and of the appropriate AWWA Standard Specifications. In the case of conflict, the more stringent specifications shall apply.
- B. Unless otherwise specified herein or shown on the plans, the minimum working pressure rating of all water works material specified herein shall be 1.5 times the operating pressure, 150 psi minimum.

- C. All coatings and materials specified herein that come in contact with potable water shall be National Sanitation Foundation (NSF) approved.

## 2.02 DUCTILE IRON PIPE

- A. Ductile iron pipe shall conform to AWWA Standard C151 and shall be the standard push-on joint type or restrained joint type as identified on the drawings. Push-on joints shall be "TYTON" type or "Fas-Tite" type without exception. Unless otherwise specified herein or shown on the plans, ductile iron pipe shall be thickness Class 52. Steel encasement, where required on the drawings or specified elsewhere, shall conform to AWWA Standard C105.
- B. Ductile iron pipe for gravity sewer and sewer force mains shall be ceramic epoxy lined with Protecto 401 Ceramic Epoxy or approved equal lining. Thickness class shall be as follows:
  - 1. Class 50 for 6"-16" up to 28 feet deep
  - 2. Class 51 for 18"-20" up to 28 feet deep
  - 3. Class 52 for 24" and larger, up to 28 feet deep
- C. Push-on or mechanical type pipe joints shall conform to AWWA Standard C111. Flanged ductile iron pipe shall conform to AWWA Standard C115.
- D. Restrained Joint Ductile Iron Pipe
  - 1. Restrained joint ductile iron pipe and fittings shall be provided as identified on the drawings and required for the application. Joint restraint for pipe shall be accomplished with an integral lock mechanism except as may be otherwise specified. Any such system shall be a manufacturer's standard proprietary design, shall be as recommended by the manufacturer for the application, and shall be performance proven.
  - 2. Restraining components for pipe shall be ductile iron in accordance with applicable requirements of ANSI/AWWA C110/A21.10 and/or C153/A21.53 with the exception of the manufacturer's proprietary design dimensions. Push-on joints for such fittings shall be in accordance with ANSI/AWWA C111/A21.11.

The following is the approved list of restrained joint systems:

- a. "Thrust-Lock", McWane Ductile.
- b. "Flex-Ring", American Cast Iron Pipe Company.

- c. "TR Flex", McWane Ductile.
- d. "Snap-Lok", Griffin Pipe Products Company.
- e. "Megalug", EBAA Iron, Inc. (fittings)
- f. "Field-Lok", McWane Ductile (for field cuts only).
- g. "Restrained Joint", McWane Ductile
- h. "MJ-TJ" pipe with "Megalugs", Pacific States Cast Iron Pipe Company.
- i. "Flex-Ring", American Cast Iron Pipe Company

Where such a system may require "Mega-Lugs" for restraint, "Mega-Lugs" shall be provided in quantities as may be required and shall be considered incidental to the joint restraint system.

- 3. Restrained joint for pipe shall be capable of being deflected after assembly as follows:

<u>Size</u>	<u>Maximum Deflection</u>
4	3°
6	3°
8	3°
10	3°
12	3°
18	1.5°

## 2.03 FITTINGS AND SPECIALS

### A. Fittings

- 1. Fittings used for joining ductile iron pipe shall be of the type, size and strength designated on the plans, elsewhere in the specifications, or in the proposal and, to the extent therein specified, shall conform to the appropriate specification in this section. Fittings shall have pressure ratings as specified above and as shown on the plans.
- 2. Fittings shall be lined and coated to match pipe.
- 3. Pipe fittings and specials used with ductile iron pipe shall be gray-iron or ductile iron and shall conform to AWWA Standard C110. Ductile iron (compact) fittings conforming to AWWA Standard C153 may be substituted in lieu of AWWA C110 fittings for fitting sizes 3 inches through 24 inches in diameter. Fittings shall be mechanical joint, push-on type,

flanged or plain-end as required and shown on the plans. When fitting joints are to be restrained, pipe joint restraint systems as specified herein shall be used.

- B. Flanges – Cast-on and threaded flanges shall conform to ANSI/AWWA C110/A21.10 and ANSI/AWWA C115/A21.15, respectively. Flanges shall be faced and drilled per ASME/ANSI B16.1. Flanges shall have flat faces and shall be attached with bolt holes straddling the vertical axis of the pipe unless otherwise shown. CONTRACTOR shall coordinate with pipe, valve and fitting suppliers to make certain that pipe, valve, and fitting flanges match in bolt diameter and pattern.

All flanged pipe shall possess a minimum Class 53 wall thickness. All flanged fittings shall be provided with bolts and gaskets as specified herein.

- C. Gaskets

Gaskets for flanged joints shall be full-faced, rated to a minimum pressure of 250 psi, and conform to the standards set in AWWA C110 and C111. Unless indicated otherwise, gaskets for flanged pipe shall be Garlock 3000 with Nitrile binder or approved equal. Ring gaskets shall not be permitted.

- D. Flexible Couplings

1. All flexible couplings shall be cast or ductile iron in accordance with ASTM Standard A536 and high strength alloy bolts and nuts conforming to ANSI/AWWA C111.
2. Insulating flexible couplings shall be of the gasketed sleeve type with insulating boot and shall be Romac Industries, Inc. Style IC501 or approved equal. All coupling materials shall be constructed to diameters that properly fit the pipe.
3. Insulating boot shall be fabricated from Nitrile Butadiene Rubber suitable for water service with electric insulating properties in accordance with ASTM D2000 3 BA 715.
4. CONTRACTOR is responsible for selecting sleeve lengths appropriate to application, recognizing longer sleeves allow larger deflections and may ease installation.

- E. Insulating Flanged Joints

Each complete insulating flange kit shall include a full faced gasket, a full-length pyrox insulating sleeve for each flange bolt and two pyrox insulating washers and two steel washers for each bolt. Gaskets shall be Garlock Style 3000 or equal.

F. Flexible Expansion Joints

Flexible expansion joints shall be installed in the locations indicated on the drawings and shall be manufactured of ductile-iron conforming to the material properties of ANSI/AWWA C153/A21.53. Flexible joints shall be provided with end connections as shown on the plans. All flexible expansion joints shall consist of an expansion joint designed and cast as an integral part of a ball and socket type flexible joint, having a minimum of 15° deflection per ball and 4" expansion. Actual expansion and deflection requirements will be as shown on the drawings. Each flexible expansion joint shall be hydrostatically tested to the manufacturer's published pressure rating prior to shipment. All pressure containing parts shall be lined with a minimum of 15 mils of Fusion Bonded Epoxy conforming to the applicable requirements of ANSI/AWWA C213 and shall be holiday tested with a 1500-volt spark test conforming to said specification. All flexible-expansion joints shall be Flex-Tend as manufactured by EBAA Iron, Inc. or approved equal.

G. Mechanical Joint Restraining Devices

Mechanical joint restraining devices shall conform to Section 9-30.2(6) of the WSDOT Standard Specifications. Joint restraint shall be epoxy coated by the manufacturer and installed per the manufacturer's recommendations.

When mechanical joint restraining devices are used at bends, mechanical joint restraining devices shall also be used on all pipe fittings within 20-feet on either side of bends unless otherwise approved by the PROJECT REPRESENTATIVE.

## PART 3 : EXECUTION

### 3.01 GENERAL

- A. All materials, workmanship and installation shall conform to referenced AWWA Standards and other requirements of these specifications. The methods employed by the CONTRACTOR in the storage, handling, and installation of pipe, fittings, valves, hydrants, equipment and appurtenances shall be such as to ensure that the material, after it is placed, tested and permanently covered by backfilling is in as good a condition as when it was shipped from the manufacturer's plant. Should any damage occur to the material, repairs or replacement shall be made to the satisfaction of the PROJECT REPRESENTATIVE.
- B. Ductile iron pipe shall be installed in accordance with AWWA Standard C600, except as modified elsewhere in these specifications. Trench excavation and



backfill of ductile iron piping system shall conform to the requirements of Section 31 23 33 – Trenching, Backfilling and Compacting for Utilities .

- C. Sanitary Sewer Separation – CONTRACTOR shall furnish all labor, equipment and materials required to replace sections of existing sanitary sewers or encase existing sanitary sewers in CDF as required to comply with State Department of Health requirements for minimum separation of sanitary sewers. Where CDF is required, wrap all utilities in 8 mill of plastic sheeting prior to placing CDF.

### **3.02 THRUST RESTRAINT**

- A. All tees, plugs, caps, bends, offsets, as well as other appurtenances which are subject to unbalanced thrust, shall be properly braced with concrete thrust blocks. Concrete thrust blocks shall have a minimum 28-day compressive strength of 3000 psi. The concrete blocking shall bear against solid undisturbed earth at the side and bottom of the trench excavation and shall be shaped so as not to obstruct access to the joints of the pipe or fittings.
- B. Where shown on the plans or specified elsewhere in the Technical Specifications, the CONTRACTOR shall provide internal or external joint restraint systems at the fittings and on all joints within the specified or shown distance on each side of the fitting or joint.

### **3.03 MECHANICAL JOINTS**

- A. For connection of mechanical joints, the socket, plain end of each pipe and gasket shall be cleaned of dirt before joining, and shall be joined according to manufacturer's directions. Bolts shall be tightened alternately at top, bottom and sides, so pressure on gasket is even.

### **3.04 TESTING**

- A. Test system according to AWWA C600.

**END OF SECTION**

THIS PAGE INTENTIONALLY LEFT BLANK

# SECTION 22 13 13 PIPE SUPPORT SYSTEMS

## PART 1 : GENERAL

### 1.01 SUMMARY

This Section specifies pipe hangers, brackets, and supports. Pipe support system shall be furnished complete with all necessary inserts, bolts, nuts, rods, washers, structural attachments, and other accessories necessary for a complete installation and specified herein.

### 1.02 REFERENCES

All pipe support materials and methods shall conform to the latest, applicable requirements of documents listed hereafter. In case of conflict between this Section and the listed documents, the requirements of this Section shall prevail.

ANSI A13.1	Piping and Piping System
ANSI/MSS SP-58	Pipe Hangers and Supports C Materials, Design, and Manufacture
ANSI/MSS SP-69	Pipe Hanger and Supports C Selection and Application
SMACNA	Seismic Restraint Manual C Guidelines for Mechanical Systems
UPC	Uniform Plumbing Code

### 1.03 SUBMITTALS

- A. In accordance with the requirements of Section 1-06 – Control of Materials, submit the following:
  - 1. Manufacturer's technical data for all hangers, brackets, supports and documentation of conformance with appropriate standards and these specifications.
  - 2. Location of pipe supports, including type of structural and pipe attachments, shown on the Drawings and/or specified under Paragraph 1.03 of Section 22 13 00 – Pipe.

## PART 2 : PRODUCTS

### 2.01 GENERAL

- A. The Contractor shall provide and install pipe support systems which include supports, anchors, expansion joints, and structural attachments. The support system shall be individual pipe clamps, supports and structural attachments as specified herein and as shown in the Drawings. The support system shall be provided in conjunction with the pipe to be supported. Seismic restraints shall be provided in accordance with SMACNA Manual as referenced in paragraph 1.03, and as required by building codes.

- B. In certain locations, pipe supports, anchors, and expansion joints have been indicated on the Drawings, but no attempt has been made to indicate every pipe support, anchor, and expansion joint. It shall be the Contractor's responsibility to provide a complete system of pipe supports.
- C. All pipe support systems, including all accessories shall be type 316 stainless steel.

## 2.02 ADJUSTABLE PIPE SUPPORT

As indicated on the drawings.

## 2.03 STRUCTURAL ATTACHMENTS

Structural attachments shall be concrete insert channels or individual inserts for new concrete, surface-mounted channel or individual inserts for existing concrete. All structural attachments including all accessories shall be Type 316 stainless steel and shall be provided by a single manufacturer. Structural attachments shall be as manufactured by Unistrut Corporation or accepted equal.

## 2.04 CHANNEL-TYPE PIPE CLAMP ASSEMBLY

- A. Channel-type pipe clamp assembly shall consist of a channel section, pipe clamp or clamps, and channel attachment bolts. The channel shall be Unistrut Corp, P1000, 1<sup>5</sup>/<sub>8</sub>-inch Single Channel. Length shall be as required to accommodate the pipe clamp or clamps, and anchor bolts. Length shall be pipe outside diameter plus 6 inches minimum.
- B. The pipe clamp shall be Unistrut, P1100 Series (Conduit) or P2000 Series (Pipe).
- C. Anchor bolts shall be type 316 stainless steel, type as required for mounting surface. A minimum of two bolts shall be used for each channel. Bolt size shall be ½-inch diameter.

## PART 3 : EXECUTION

### 3.01 DESIGN

- A. Pipe support system shall be designed in accordance with applicable reference standards specified in paragraph 1.03. Pipe supports shall be designed and selected to withstand seismic loads per the UBC, and shall adhere to the following:
  - 1. Weight balance calculations shall be made to determine the required supporting force at each pipe support location and the pipe weight at each equipment location. Design loads for inserts, clamps, and other support items shall not exceed the manufacturer's recommended loads.
  - 2. Pipe supports shall be able to support the pipe in all conditions of operation. They shall allow free expansion and contraction of the piping and prevent excessive stress resulting from transferred weight being induced into the pipe or connected equipment. Allow clearances for pipe expansion and contraction.

3. Wherever possible, pipe attachments for horizontal and vertical piping shall be channel-type pipe clamp assemblies, or as shown on the pipe support detail sheet. Horizontal or vertical pipes should be supported preferably at locations of least vertical movement.
4. All pipe supports shall provide a means of vertical adjustment after erection.
5. Where practical, riser pipe shall be supported independently of the connected horizontal piping. Pipe support attachments to the riser piping shall be riser clamps.

### 3.02 INSTALLATION

- A. Pipe support system shall be installed strictly in accordance with standards and codes referenced in paragraph 1.03, and recommendations of the piping support system manufacturer and piping manufacturer.
- B. All piping shall be rigidly supported and anchored so that there is no movement or visible sagging between supports.
- C. Contact between dissimilar metals, including contact between stainless steel and carbon steel, shall be prevented. Supports for brass or copper pipe or tubing shall be copper-plated. Those portions of pipe supports which contact other dissimilar metals shall be rubber- or vinyl-coated.
- D. Anchorage shall be provided to resist thrust due to temperature changes, changes in diameter or direction, or dead ending. Anchors shall be located as required to force expansion and contract movement to occur at expansion joints, loops, or elbows, and as required to prevent excessive bending stresses and opening of mechanical couplings. Anchorage for temperature changes shall be centered between elbows and mechanical joints used as expansion joints.
- E. Pipe supports and expansion joints are not required in buried piping, but concrete thrust blocking or other approved anchorage shall be provided as indicated on the Drawings or specified in other sections.

**END OF SECTION**

THIS PAGE INTENTIONALLY LEFT BLANK

**SECTION 22 13 15**  
**VALVES: BASIC REQUIREMENTS**

**PART 1 : GENERAL**

**1.01 SUMMARY**

- A. Section Includes:
1. General requirements for valves and valve appurtenances.

**1.02 QUALITY ASSURANCE**

- A. Referenced Standards:
1. American Society of Mechanical Engineers (ASME):
    - a. B16.1, Gray Iron Pipe Flanges and Flanged Fittings: Classes 25, 125, and 250.
  2. ASTM International (ASTM):
    - a. A126, Standard Specification for Gray Iron Castings for Valves, Flanges, and Pipe Fittings.
  3. American Water Works Association (AWWA):
    - a. C507, Standard for Ball Valves, 6 IN through 48 IN.
    - b. C509, Standard for Resilient-Seated Gate Valves for Water Supply Service.
    - c. C550, Standard for Protective Coatings for Valves and Hydrants.
  4. American Water Works Association/American National Standards Institute (AWWA/ANSI):
    - a. C111/A21.11, Standard for Rubber-Gasket Joints for Ductile-Iron Pressure Pipe and Fittings.

**1.03 DEFINITIONS**

- A. The following are definitions of abbreviations used in this Specification Section or one (1) of the individual valve sections:
1. CWP: Cold water working pressure.
  2. WOG: Water, oil, gas working pressure.
  3. WWP: Water working pressure.

**1.04 SUBMITTALS**

- A. In accordance with the provisions of Section 1-06 – Control of Materials, submit the following:
  - 1. Product technical data including:
    - a. Acknowledgement that products submitted meet requirements of standards referenced.
    - b. Manufacturer's installation instructions.
    - c. Valve pressure and temperature rating.
    - d. Valve material of construction.
    - e. Special linings.
    - f. Valve dimensions and weight.
    - g. Valve flow coefficient.
  - 2. Test reports.
  - 3. Operation and Maintenance Manuals:

**PART 2 : PRODUCTS****2.01 ACCEPTABLE MANUFACTURERS**

- A. Subject to compliance with the Contract Documents, refer to individual valve Specification Sections for acceptable manufacturers.
- B. Submit request for substitution in accordance with Division 1.

**2.02 MATERIALS**

Refer to individual valve Specification Sections.

**2.03 FABRICATION**

- A. End Connections:
  - 1. Provide the type of end connections for valves as required in the Piping System Specifications presented in Section 22 13 11 – Piping Systems or as shown on the Drawings.
  - 2. Comply with the following standards:
    - a. Threaded: ASME B1.20.1.
    - b. Flanged: ASME B16.1, Class 125 unless otherwise noted or AWWA C207.
    - c. Bell and spigot or mechanical (gland) type: AWWA/ANSI C111/A21.11.
    - d. Soldered: ASME B16.18.
    - e. Grooved: Rigid joints per Table 5 of AWWA C606.



3. Refer to individual valve Specification Sections for specifications of each type of valve used on Project.
4. Nuts, Bolts, and Washers:
5. Wetted or internal to be bronze or stainless steel:
  - a. Exposed to be zinc or cadmium plated.
- B. Epoxy Interior Coating: Provide epoxy interior coating for all ferrous surfaces in accordance with AWWA C550.

**PART 3 : EXECUTION****3.01 INSTALLATION**

- A. Install products in accordance with manufacturer's instructions.
- B. Painting Requirements: Comply with Specification Section 09 96 00 – Painting and Protective Coatings.
- C. Setting Buried Valves:
  1. Locate valves installed in pipe trenches where buried pipe indicated on Drawings.
  2. Set valves and valve boxes plumb.
  3. Place valve boxes directly over valves with top of box being brought to surface of finished grade.
  4. Install in closed position.
  5. Place valve on concrete footing in trench to prevent settling and excessive strain on connection to pipe.
  6. After installation, backfill up to top of box for a minimum distance of 4 FT on each side of box.
- D. Support exposed valves and piping adjacent to valves independently to eliminate pipe loads being transferred to valve and valve loads being transferred to the piping.
- E. For grooved coupling valves, install rigid type couplings or provide separate support to prevent rotation of valve from installed position.
- F. For threaded valves, provide union on one (1) side within 2 FT of valve to allow valve removal.
- G. Install valves accessible for operation, inspection, and maintenance.

**3.02 ADJUSTMENT**

- A. Adjust valves, and appurtenant equipment to comply with Division 0/1:
  - 1. Operate valve, open and close at system pressures.

**END OF SECTION**

**SECTION 22 13 19  
PIPE APPURTENANCES**

**PART 1 : GENERAL**

**1.01 SUMMARY**

Piping appurtenances include, but are not limited to mechanical couplings, unions, sleeves, transition fittings, link type wall seals, flexible boot connections, and tracer wire.

**1.02 REFERENCES**

ASTM A 276 Standard Specification for Stainless Steel Bars and Shapes

ASTM A 536 Standard Specification for Ductile Iron Castings

ASTM F 593 Standard Specification for Stainless Steel Bolts, Hex Cap Screws, and Studs

AWWA C207 Standard for Steel Pipe Flanges for Waterworks Service - Sizes 4 In. Through 144 In. (100 mm Through 3,600 mm)

Standard Specifications - 2021 WSDOT Standard Specifications for Road, Bridge, and Municipal Construction

**1.03 SUBMITTALS**

- A. In accordance with the requirements of Section 1-06 – Control of Materials, submit the following:
  - 1. Catalog information.
  - 2. Manufacturer's installation instructions.

**PART 2 : PRODUCTS**

**2.01 RESTRAINED FLEXIBLE COUPLINGS**

- A. Manufacturers shall be, no equal:
  - 1. Romac Industries, Inc. Alpha.
  - 2. Romac Industries, Inc. 400 RG.
- B. Design: Accommodate 4 degrees working deflection per end of coupling.
- C. Rated Working Pressure: 350 psi.
- D. Material:
  - 1. Ductile iron in accordance with ASTM A 536.
  - 2. ASTM A 36 steel.
- E. Bolts and Hex Nut Material: Type 304 stainless steel in accordance with ASTM F 593.

- F. Coating and Lining: Manufacturer's standard fusion bonded epoxy.

## 2.02 RESTRAINED FLANGED COUPLING ADAPTER

- A. Manufacturers, one of the following or equivalent.
  - 1. Romac Industries, Inc. Style RFCA.
  - 2. Star Pipe Products, StarFlange Series 3200.
- B. Flange, Body, Follower Ring, Restraining Lug and Restraining Bolt Material: Ductile iron in accordance with ASTM A 536.
- C. Bolt heads shall be designed to twist off when proper torque has been applied.
- D. Bolts and Hex Nut Material: Type 316 stainless steel in accordance with ASTM F 593.
- E. Flange Design: Class D steel ring flange in accordance with AWWA C207 compatible with ANSI Class 125 and 150 bolt circles.
- F. Coating and Lining: Manufacturer's standard fusion bonded epoxy.
- G. Coupling shall allow angular deflection after assembly.

## 2.03 UNIONS

Unions 2 inches and smaller shall be threaded joint, malleable iron type. Unions 2½ inches and larger shall be flanged type, 150-pound flanges.

## 2.04 MECHANICAL JOINT RESTRAINT COUPLINGS

- A. For use on Ductile Iron Pipe:
  - 1. Manufacturer: Manufacturer: EBBA Iron, MEGALUG Series 1100 Mechanical Joint Restraint, or accepted equal.
- B. For use on HDPE Pipe:
  - 1. Manufacturer: Manufacturer: EBBA Iron, Series 2000PV HDPE Restraint, or accepted equal.
    - a. Install with internal type 316 stainless steel stiffener, sized to encompass the full bearing length of the restraint device.

## 2.05 FLEXIBLE BOOT CONNECTION

- A. Flexible rubber pipe to manhole connector in accordance with ASTM C923.
- B. Suitable for raw sewage application.
- C. Stainless steel band construction.
- D. Manufacturer: Trelleborg, Kor-N-Seal, or accepted equal.

**2.10 TRACER WIRE**

- A. Wire:
  - 1. 12 GA AWG.
  - 2. Solid.
  - 3. High density polyethylene insulation.
  - 4. Suitable for wet, buried applications.
  - 5. No buried splices.
- B. Wire nuts: Waterproof type.
- C. Split bolts: Brass.

**PART 3 : EXECUTION**

**3.01 GENERAL**

- A. Install in accordance with manufacturer's instructions.
- B. Install centered without angular deflection, unless shown otherwise on the Drawings.

**3.02 SLEEVE-TYPE COUPLINGS**

- A. Sleeve-type couplings shall be employed where shown on the Drawings or specified herein, as takedown couplings on large diameter pipelines, to provide flexibility in buried piping systems at connections to structures, and as a general pipe coupling where required or permitted by Section 22 13 00 – Pipe.
- B. Sleeve-type couplings shall be installed in accordance with the specifications and the manufacturer's instructions.

**3.03 RESTRAINED FLANGE COUPLING ADAPTERS**

Restrained flange coupling adapters shall be installed in accordance with manufacturer's recommendations.

**3.04 UNIONS**

Unions shall be used as shown on the Drawings and, if not shown, shall be provided to permit easy assembly/disassembly of equipment and removal of valves.

**3.05 DIELECTRIC UNIONS**

Dielectric unions shall be used whenever two dissimilar pipe materials are joined.

**END OF SECTION**

THIS PAGE INTENTIONALLY LEFT BLANK

## **SECTION 31 10 00 SITE CLEARING**

### **PART 1 : GENERAL**

#### **1.01 SUMMARY**

This Section includes site clearing, grubbing and stripping, and removal of all trash, shrubs and debris, and other unsuitable material within limits of clearing.

#### **1.02 REFERENCES**

- A. Clearing, grubbing, and stripping shall be in accordance with the provisions of Sections 2-01 and 2-02 of the Standard Specifications, and to requirements specified herein. In the event of conflicts, the more restrictive requirement shall apply.
  - 1. Standard Specifications - 2021 WSDOT Standard Specifications for Road, Bridge, and Municipal Construction.

### **PART 2 : PRODUCTS**

NOT USED

### **PART 3 : EXECUTION**

#### **3.01 PREPARATION**

- A. Protect existing trees and other vegetation to remain against damage:
  - 1. Do not smother trees by stockpiling construction materials or excavated materials within drip line.
  - 2. Avoid foot or vehicular traffic or parking of vehicles within drip line.
  - 3. Provide temporary protection as required.
- B. Repair or replace trees and vegetation not designated for removal that are damaged by construction operations:
  - 1. Repairs to be performed by a qualified tree surgeon.
  - 2. Remove trees that cannot be repaired and restored to full-growth status.
  - 3. Replace with new trees of minimum 4 IN caliper.
  - 4. Owner will obtain authority for removal and alteration work on adjoining property, if needed.

#### **3.02 SITE CLEARING**

- A. Topsoil removal:
  - 1. Strip topsoil to depths encountered.
    - a. Remove heavy growths of grass before stripping.
    - b. Stop topsoil stripping sufficient distance from trees not designated

- for removal to prevent damage to main root system.
- c. Separate from underlying subsoil or objectionable material.
- 2. Stockpile topsoil for subsequent reuse.
  - a. Construct storage piles to freely drain surface water.
  - b. Seed or cover storage piles to prevent erosion.
- B. Clearing and grubbing:
  - 1. Clear from within limits of clearing all trees not marked to remain:
    - a. Include shrubs, brush, downed timber, rotten wood, heavy growth of grass and weeds, vines, rubbish, structures, and debris.
  - 2. Grub (remove) from within limits of clearing all stumps, roots, root mats, logs and debris encountered:
    - a. Totally grub under areas to be paved.
    - b. Grubbing in lawn areas:
      - 1) In cut areas, totally grub.
      - 2) In fill areas, where fill is less than 3 FT, totally grub ground.
      - 3) Where fill is 3 FT or more in depth, stumps may be left no higher than 6 IN above existing ground surface.
  - 3. Fill depressions caused by clearing and grubbing operations with satisfactory soil material, unless further excavation or earthwork is indicated. Place fill material in horizontal layers not to exceed six (6) inches loose depth, and thoroughly compact to a density equal to adjacent original ground.
- C. Disposal of waste materials:
  - 1. Do not burn combustible materials on site.
  - 2. Remove all waste materials from site and dispose of at an appropriate refuse facility.
  - 3. Remove all vegetative waste from the site and transport to an appropriate composting facility.
  - 4. Do not bury organic matter on site.

### 3.03 ACCEPTANCE

Upon completion of the site clearing, obtain the Engineer's acceptance of the extent of clearing, depth of stripping, and rough grade.

**END OF SECTION**



## **SECTION 31 23 18 ROCK REMOVAL**

### **PART 1 : GENERAL**

#### **1.01 SUMMARY**

- A This Section includes removal of subsurface rock during excavation by mechanical method. The use of explosives for rock removal is not permitting for this project.
- B Section Includes:
1. Removing identified and discovered rock during excavation.
  2. Expansive tools to assist rock removal.
- C Related Sections:
1. Section 31 23 33 - Trenching, Backfilling, and Compacting for Utilities
  2. Section 31 23 24 – Flowable Fill
  3. Section 31 41 00 – Excavation Support Systems
  4. Supplemental Information: Geotechnical Engineering Report, Bangor-Keyport Force Main Replacement Kitsap County, Washington, September 3, 2020, Landau Associates.

#### **1.02 NOT USED**

#### **1.03 DEFINITIONS**

- A Common Excavation: All excavation required for Work, regardless of the type, character, composition, or condition of the material encountered. All excavation shall be classified as Common Excavation, unless provided for under Rock Removal below.
- B Common Material: All soils, aggregate, debris, junk, broken concrete, and miscellaneous material encountered in Common Excavation, excluding rock as defined below.
- C Rock: Solid mineral material, including boulders, solid bedrock, or ledge rock, with volume in excess of 1/2 cubic yard or solid material which, by actual demonstration, cannot be reasonably excavated with suitable machinery as defined herein. The Engineer may waive the requirements for actual demonstration if the material encountered is well-defined rock.
- D Rock Removal: Removal of rock as defined herein by systematic and continuous drilling, hammering, breaking, splitting, or other methods approved by the Engineer.

- E Suitable Machinery: A track-mounted hydraulic excavator of the 52,800- to 72,500-pound class equipped with a single shank ripper.

**1.04 SUBMITTALS**

- A Submit in accordance with the provisions of Section 1-06 – Control of Materials.
- B Shop Drawings: Indicate proposed method of rock removal.
- C Equipment: Manufacturer information regarding pound class of machinery proposed for rock removal.
- D Survey Report: Submit survey report mapping extent and locations of rock encountered, to be used in calculating total volume of rock removal.

**1.05 NOT USED**

**1.06 PROJECT CONDITIONS**

- A Conduct survey of rock uncovered in excavation for structures or trenching for utilities prior to removal of material.

**PART 2 : PRODUCTS**

NOT USED

**PART 3 : EXECUTION**

**3.01 EXAMINATION**

- A Verify site conditions and note subsurface irregularities affecting Work of this section.

**3.02 PREPARATION**

- A Identify required lines, levels, contours, and datum.
- B Engineer Approval for Rock Removal:
  - 1. Prior to commencement of rock removal, expose all material anticipated to be rock by removing the common material above it and then notify the Engineer.
  - 2. The Engineer, in association with the Contactor or the Contractor's representative, will measure the amount of material to be removed in an effort to reach a mutually agreeable volume for anticipated rock removal.
  - 3. Prior to commencing the proposed rock removal, the Contractor must receive written approval by the Engineer stating the approximate volume of excepted rock removal to receive payment.

4. During rock removal activities, should it become apparent the previously agreed upon volume of rock removal will be exceeded, notify the Engineer immediately. Should the Contractor proceed with rock removal in excess of the previously agreed upon volume, the Contractor will do so at their own risk and expense.

### 3.03 ROCK REMOVAL BY MECHANICAL METHOD

- A Excavate and remove rock by mechanical method.
  1. Use single shank ripper to fracture rock.
  2. Drill holes and use expansive tools and wedges to fracture rock.
- B Cut away rock at bottom of excavation to form level bearing.
- C Remove shaled layers to provide sound and unshattered base for footings and foundations.
- D In utility trenches, excavate to 6 inches below invert elevation of pipe and 24 inches wider than pipe diameter.
- E For vaults and other structures, excavate to the depth necessary to install the structure and to a maximum of 18 inches beyond the outside walls of the vault or structure.
- F Remove excavated materials from site.
- G Correct unauthorized rock removal associated with structural excavations in accordance with backfilling and compacting requirements of Section 31 23 33, Trenching, Backfilling and Compacting for Utilities and as directed by Engineer.
- H Correct unauthorized rock removal associated with utility work in accordance with backfilling and compacting requirements of Section 31 23 33, Trenching, Backfilling and Compacting for Utilities and as directed by Engineer.
- I If material which would be classified as rock as defined herein is mechanically removed with equipment of a larger size than specified as Suitable Machinery herein, it shall be understood that any added costs for the removal of rock by this method shall be included in the unit price for common excavation and not paid for under this pay item. If material which would be classified as rock as defined herein is mechanically removed without [blasting,] hammering, breaking, or splitting, it will be considered common excavation and not paid for under this pay item. If equipment larger than the suitable machinery as defined herein is brought on the project site for the sole purpose of rock removal without hammering, breaking, or splitting, then such excavation will be considered rock removal.

**3.04 FIELD QUALITY CONTROL**

- A Request visual inspection of foundation bearing surfaces by Engineer before installing subsequent work.

**END OF SECTION**

# SECTION 31 23 19 DEWATERING

## PART 1 : GENERAL

### 1.01 SUMMARY

A This Section includes temporary dewatering and surface water control systems for open excavations and utility trenches.

B Section includes:

1. Dewatering systems.
2. Surface water control systems.
3. System operation and maintenance.
4. Water disposal.

### 1.02 RELATED SECTIONS

A Section 31 10 00 – Site Clearing

B Section 31 23 33 – Trenching, Backfilling, and Compacting for Utilities

C Section 31 23 43 – Earthwork

D Section 31 41 00 – Excavation Support Systems

### 1.03 SUBMITTALS

A Dewatering Plan:

1. Descriptions of proposed groundwater and surface water control facilities including, but not limited to, equipment; methods; standby equipment and power supply; pollution control facilities; discharge locations to be utilized; and provisions for immediate temporary water supply as required by this Section.
2. Plan to be reviewed by the Engineer prior to the beginning of construction activities requiring dewatering. Review by the Engineer of the design shall not be construed as a detailed analysis of the adequacy of the dewatering system, nor shall any provisions of the above requirements be construed as relieving the Contractor of its overall responsibility and liability for the work.

### 1.04 DEFINITIONS

A Dewatering includes the following:

1. Lowering of ground water table and intercepting horizontal water seepage to prevent ground water from entering excavations, trenches, tunnels, and /or shafts.
2. Reducing piezometric pressure within strata to prevent failure or heaving of excavations, trenches, tunnels, and /or shafts.

3. Disposing of removed water.
4. Surface Water Control: Removal of surface water within open excavations.

### 1.05 QUALITY CONTROL

A All dewatering operations shall be adequate to assure the integrity of the finished project and shall be the responsibility of the Contractor.

B Provide all labor, materials, and equipment necessary to dewater trench and structure excavations, in accordance with the requirements of the Contract Documents.

C Secure all necessary permits to complete the requirements of this Section.

D Control the rate and effect of the dewatering in such a manner as to avoid all objectionable settlement and subsidence.

E Where the critical structures or facilities exist immediately adjacent to areas of proposed dewatering, reference points shall be established and observed at frequent intervals to detect any settlement which may develop.

1. The responsibility for conducting the dewatering operation in a manner which will protect adjacent structures and facilities rests solely with the Contractor.
2. The cost of repairing any damage to adjacent structures and restoration of facilities shall be the responsibility of the Contractor.

## PART 2 : PRODUCTS

### 2.01 EQUIPMENT

Dewatering, where required, may include the use of well points, sump pumps, temporary pipelines for water disposal, rock or gravel placement, and other means. Standby pumping equipment shall be maintained on the jobsite.

## PART 3 : EXECUTION

### 3.01 DEWATERING

A Provide all equipment necessary for dewatering.

1. Have on hand, at all times, sufficient pumping equipment and machinery in good working condition.
2. Have available, at all times, competent workers for the operation of the pumping equipment.
3. Adequate standby equipment shall be kept available at all times to insure efficient dewatering and maintenance of dewatering operation during power failure.

B Dewatering for structures and pipelines shall commence when groundwater is first encountered and shall be continuous until such times as water can be allowed to rise in accordance with the provisions of this Section or other requirements.

- C Site Grading:
1. At all times, site grading shall promote drainage.
  2. Surface runoff shall be diverted from excavations.
  3. Water entering the excavation from surface runoff shall be collected in shallow ditches around the perimeter of the excavation, drained to sumps, and be pumped or drained by gravity from the excavation to maintain a bottom free from standing water.
- D Dewatering shall at all times be conducted in such a manner as to preserve the undisturbed bearing capacity of the subgrade soils at proposed bottom of excavation.
- E If foundation soils are disturbed or loosened by the upward seepage of water or an uncontrolled flow of water, the affected areas shall be excavated and replaced with drain rock.
- F Maintain the water level below the bottom of excavation in all work areas where groundwater occurs during excavation construction, backfilling, and up to acceptance.
- G Flotation shall be prevented by maintaining a positive and continuous removal of water. The Contractor shall be fully responsible and liable for all damages which may result from failure to adequately keep excavations dewatered.
- H If well points or wells are used, they shall be adequately spaced to provide the necessary dewatering and shall be sandpacked and/or other means used to prevent pumping of fine sands or silts from the subsurface. A continual check shall be maintained to ensure that the subsurface soil is not being removed by the dewatering operation.
- I Dispose of water from the work in a suitable manner without damage to the environment or adjacent property. No water shall be drained into work built or under construction without prior consent of the Engineer. Water shall be filtered using an approved method to remove sand and fine sized soil particles before disposal into any drainage system.
- J The release of groundwater to its static level shall be performed in such a manner as to maintain the undisturbed state of the natural foundation soils, prevent disturbance of compacted backfill and prevent flotation or movement of structures, pipelines, and sewers.
- K Dewatering of trenches and other excavations shall be considered as incidental to the construction of the work and all costs thereof shall be included in the various contract prices in the bid forms.

**END OF SECTION**

THIS PAGE INTENTIONALLY LEFT BLANK



# SECTION 31 23 24 FLOWABLE FILL

## PART 1 : GENERAL

### 1.01 SUMMARY

- A. This Section includes flowable lean concrete mix used for structure backfill, utility bedding and backfill and other subgrade Site Work. Applications also include filling abandoned structures and utilities that remain in place.
- B. Section Includes:
  - 1. Filling abandoned utilities

### 1.02 RELATED SECTIONS

- A. Section 33 11 50 - Existing Pipe Abandonment

### 1.03 DEFINITIONS

- A. Flowable Fill: Also referred to as Controlled Low Strength Material (CLSM) elsewhere in the Specifications. Lean cement concrete fill.
- B. Utility: Any buried pipe, duct, conduit, manhole, tank, or cable.

### 1.04 REFERENCE STANDARDS

- A. ASTM International (ASTM):
  - 1. ASTM C33 - Standard Specification for Concrete Aggregates
  - 2. ASTM C94 - Standard Specification for Ready-Mixed Concrete
  - 3. ASTM C150 - Standard Specification for Portland Cement
  - 4. ASTM C260 - Standard Specification for Air-Entraining Admixtures for Concrete
  - 5. ASTM C403 - Standard Test Method for Time of Setting of Concrete Mixtures by Penetration Resistance
  - 6. ASTM C494 - Standard Specification for Chemical Admixtures for Concrete
  - 7. ASTM C618 - Standard Specification for Coal Fly Ash and Raw or Calcined Natural Pozzolan for Use as a Mineral Admixture in Concrete
  - 8. ASTM C1017 - Standard Specification for Chemical Admixtures for Use in Producing Flowing Concrete
  - 9. ASTM C1040 - Standard Test Methods for Density of Unhardened and Hardened Concrete in Place by Nuclear Methods
  - 10. ASTM D4832 - Standard Test Method for Preparation and Testing of Controlled Low Strength Material (CLSM) Test Cylinders

### 1.05 SUBMITTALS

- A. Submit in accordance with the provisions of Section 1-06 – Control of Materials

- B. Manufacturer's Certificate: Certify that products meet or exceed specified requirements.
- C. Field Quality-Control Submittals:
  - 1. Mix Design:
    - a. Furnish flowable fill mix design for each specified strength.
    - b. Furnish separate mix designs when admixtures are required for the following:
      - 1) Flowable fill Work during hot and cold weather.
      - 2) Air entrained flowable fill Work.
    - c. Identify design mix ingredients, proportions, properties, admixtures, and tests.
  - 2. Furnish test results to certify flowable fill mix design properties meet or exceed specified requirements.
- D. Delivery Tickets:
  - 1. Furnish duplicate delivery tickets indicating actual materials delivered to Project Site.

**1.06 QUALITY ASSURANCE**

- A. In-place testing of Flowable Fill: In accordance with ASTM C403.

**1.07 ENVIRONMENTAL REQUIREMENTS**

- A. Minimum Conditions: The following minimum conditions shall be met at time of flowable fill placement.
  - 1. Do not install flowable fill during inclement weather.
  - 2. Ambient temperature must be at least 34 degrees Fahrenheit (F) (4 degrees Celsius (C)) and rising.
  - 3. Flowable fill shall be at 40 degrees F (4 degrees C).

**1.08 FIELD MEASUREMENTS**

- A. Verify field measurements before installing flowable fill to establish quantities required to complete the Work.

**PART 2 : PRODUCTS****2.01 MATERIALS**

- A. Flowable fill shall be in accordance with Standard Specification 2-09.3(1)E.

**PART 3 : EXECUTION****3.01 EXAMINATION**

- A. Verify utility abandonment as specified elsewhere in the specifications is complete and tested before placing flowable fill.

**3.02 PREPARATION**

- A. Support and restrain utilities to prevent movement and flotation during installation of flowable fill.
- B. Protect structures and utilities from damage caused by hydraulic pressure of flowable fill before fill hardens.
- C. Protect utilities and foundation drains to prevent intrusion of flowable fill.

**3.03 INSTALLATION - FILLING ABANDONED UTILITIES**

- A. As specified in Section 33 11 50, Existing Pipe Abandonment.

**3.04 FIELD QUALITY CONTROL**

- A. Perform inspection and testing according to ASTM C94.
  - 1. Take samples for tests for every 100 cubic yards of flowable fill, or fraction thereof, installed each day.
  - 2. Sample, prepare, and test four compressive strength test cylinders according to ASTM D4832. Test one specimen at 3 days, one at 7 days, and two at 28 days.
  - 3. Measure temperature at point of delivery when samples are prepared.
- B. Further construction proceeding upon placed flowable fill will be permitted only after initial set is attained, as measured by ASTM C 403.
  - 1. Perform in place penetration (density) tests using handheld penetrometer to measure penetration resistance of hardened flowable fill.
  - 2. Perform tests at locations as directed by Engineer.
- C. Defective Flowable Fill: The Engineer reserves the right to reject all flowable fill failing to meet the following test requirements or flowable fill delivered without the following documentation.
  - 1. Test Requirements:
    - a. Minimum temperature at point of delivery.
    - b. Compressive strength requirements for each type of fill.
  - 2. Documentation: Duplicate delivery tickets.
- D. No traffic or construction equipment shall be allowed on flowable fill for a least 24 hours after placement.

**3.05 CLEANING**

- A. Remove spilled and excess flowable fill from Project Site.
- B. Restore facilities and Site areas damaged or contaminated by flowable fill installation to existing condition before installation.

**END OF SECTION**

**SECTION 31 23 33**  
**TRENCHING, BACKFILLING, AND COMPACTING FOR UTILITIES**

**PART 1 : GENERAL**

**1.01 SUMMARY**

- A. Section includes:
1. Excavation, trenching, backfilling, and compacting for all underground utilities.
  2. Excavation of earthwork of whatever consistency encountered.
  3. Over-excavation of materials as directed by the Engineer.
  4. Handling of excavated materials and associated cleanup.
  5. Providing and placing various fill materials in accordance with the Contract Documents.
  6. Compacting existing and imported materials suitable for the contemplated loadings.

**1.02 REFERENCES**

- A. ASTM International (ASTM):
1. C33, Standard Specification for Concrete Aggregates.
  2. C131, Standard Test Method for Resistance to Degradation of Small-Size Coarse Aggregate by Abrasion and Impact in the Los Angeles Machine.
  3. C136, Standard Test Method for Sieve Analysis of Fine and Coarse Aggregates.
  4. D698, Standard Test Methods for Laboratory Compaction Characteristics of Soil Using Standard Effort (12,400 ft-lbf/ft<sup>3</sup> (600 kN-m/m<sup>3</sup>)).
  5. D1241, Standard Specification for Materials for Soil-Aggregate Subbase, Base, and Surface Courses
  6. D1557, Standard Test Methods for Laboratory Compaction Characteristics of Soil Using Modified Effort (56,000 ft-lbf/ft<sup>3</sup> (2,700 kN-m/m<sup>3</sup>)).
  7. D2321, Standard Practice for Underground Installation of Thermoplastic Pipe for Sewers and Other Gravity-Flow Applications.
  8. D2922, Standard Test Methods for Density of Soil and Soil-Aggregate in Place by Nuclear Methods (Shallow Depth).
  9. D4253, Standard Test Methods for Maximum Index Density and Unit Weight of Soils Using a Vibratory Table.
  10. D4254, Standard Test Methods for Minimum Index Density and Unit Weight of Soils and Calculation of Relative Density.

- B. Standard Specifications for Road, Bridge, and Municipal Construction, 2021 by the Washington State Department of Transportation.
- C. Reference Document: Geotechnical Engineering Report, Bangor-Keyport Force Main Replacement Kitsap County, Washington , September 3, 2020, Landau Associates.

**1.03 QUALITY ASSURANCE**

Registered professional engineer licensed in the State of Washington for design of shoring systems or other excavation safety plans in accordance with Section 31 41 00 – Excavation Support Systems.

**1.04 DEFINITIONS**

Excavation: all excavation will be defined as unclassified.

**1.05 SUBMITTALS**

- A. Submit in accordance with the provisions of Section 1-06 – Control of Materials.
- B. Product technical data including:
  - 1. Acknowledgement that products submitted meet requirements of standards referenced.
  - 2. Manufacturer's installation instructions.
- C. Submit respective pipe or conduit manufacturer's data regarding bedding methods of installation and general recommendations.
- D. Mix design for controlled density fill (CDF).
- E. Test reports:
  - 1. Submit sieve analysis reports on all granular materials in accordance with ASTM C136.
  - 2. Submit maximum laboratory density test data (maximum modified proctor) in accordance with ASTM D1557 on all materials subject to compaction testing.
  - 3. If the source or quality of any materials changes during construction, the Contractor shall furnish additional test reports to the Owner for review and acceptance prior to the use of the different material.
- F. Informational submittals for Excavation Support Systems: see Section 31 41 00 – Excavation Support Systems.
- G. See Section 31 23 43 – Earthwork

**1.06 PROJECT CONDITIONS**

- A. Avoid overloading or surcharging a sufficient distance back from edge of excavation to prevent slides or caving:

1. Maintain and trim excavated materials in such manner to be as little inconvenience as possible to public and adjoining property owners.
- B. Provide full access to public and private premises and fire hydrants, at street crossings, sidewalks, and other points as designated by the Owner to prevent serious interruption of travel.
- C. Protect and maintain bench marks, monuments, or other established points and reference points; and if disturbed or destroyed, replace items in accordance with WAC 332-120 to full satisfaction of the Owner and controlling agency.
- D. Verify location of existing underground utilities.

## **PART 2 : PRODUCTS**

### **2.01 MATERIALS**

- A. Trench Backfill:
  1. Gravel Borrow for Trench Backfill: in accordance with Section 9-03.14(1) of the Standard Specifications. During wet weather construction, the amount of fines (material passing a U.S. No. 200 sieve) shall not exceed 5 percent by dry weight, based on a wet sieve analysis of that portion passing the ¾-inch sieve.
- B. Pipe Zone Bedding:
  1. Wastewater:
    - a. Gravel Backfill for Pipe Zone Bedding: in accordance with Section 9-03.12(3) of the Standard Specifications. During wet weather construction, the amount of fines (material passing a U.S. No. 200 sieve) shall not exceed 5 percent by dry weight, based on a wet sieve analysis of that portion passing the ¾-inch sieve.
- C. Foundation Material (Gravel Backfill for Foundation):
  1. If unsuitable materials are encountered:
    - a. Foundation Material, Class A: in accordance with Section 9-03.17 of the Standard Specifications.
- D. Controlled Density Fill (CDF) shall be in accordance with Standard Specification Section 2-09.3(1)E.

## **PART 3 : EXECUTION**

### **3.01 GENERAL**

Remove and dispose of unsuitable materials from the site.

### **3.02 EXCAVATION**

- A. Remove rock excavation, clay, silt, gravel, hard pan, loose shale, and loose stone, as shown on the Drawings or as directed by the Engineer.

- B. Excavation for appurtenances:
1. 12 IN (minimum) clear distance between outer surface and embankment.
  2. See Specification Section 31 23 43 – Earthwork for applicable requirements.
- C. Groundwater dewatering shall conform to Section 31 23 43 – Earthwork.
- D. Trench excavation:
1. Excavate trenches to depth shown on the Drawings and as necessary to accommodate work.
  2. Support existing utility lines where proposed work crosses at a lower elevation.
  3. Stabilize excavation to prevent undermining of existing utility.
  4. Open trench outside buildings, units, and structures:
    - a. No more than 300 LF at any one time .
    - b. Field adjust limitations as weather conditions dictate.
    - c. All trenches shall be backfilled or covered with sheeting prior to the end of each day's work.
  5. Trenching within units, or structures:
    - a. No more than 100 LF at any one time.
  6. Observe the following trenching criteria:
    - a. Excavate width to accommodate free working space.
    - b. Maximum trench width at top of pipe or conduit may not exceed outside diameter of utility service by more than the dimensions shown on the Drawings.
    - c. Cut trench walls vertically from bottom of trench to 1 FT above top of pipe, conduit, or utility service at a minimum.
    - d. Keep trenches free of surface water runoff.
- E. Flowable fill or CDF:
1. CDF shall be:
    - a. Discharged from a mixer by any means acceptable to the Engineer into the area to be filled.
    - b. Placed in 4 FT maximum lifts to the elevations indicated:
      - 1) Allow 12 HR set-up time before placing next lift or as approved by the Engineer.
      - 2) Contractor shall place CDF lifts in such a manner as to prevent flotation of the pipe.
  2. CDF shall not be placed on frozen ground.



3. Subgrade on which CDF is placed shall be free of disturbed or softened material and water.
4. Conform to appropriate requirements of Section 31 23 43 – Earthwork.
5. CDF batching, mixing, and placing may be started if weather conditions are favorable, and the air temperature is 34 DegF and rising.
6. At the time of placement, CDF shall have a temperature of at least 40 DegF.
7. Mixing and placing shall stop when the air temperature is 38 DegF or less and falling.
8. Each filling stage shall be as continuous an operation as is practicable.
9. Contractor shall prevent traffic contact with CDF for at least 24 HRS after placement or until CDF is hard enough to prevent rutting by construction equipment.
10. CDF shall not be placed until water has been controlled or groundwater level has been lowered in accordance with the requirements of groundwater dewatering in Section 31 23 43 – Earthwork.

**3.03 PREPARATION OF FOUNDATION FOR PIPE LAYING****A. Over-excavation:**

1. If unsuitable foundation material is encountered, it shall be overexcavated, backfilled as specified and compacted to 90 percent of maximum dry density per ASTM D1557.

**B. Rock excavation:**

1. Excavate a minimum of 6 IN below bottom exterior surface of the pipe or conduit.
2. Form bell holes in trench bottom.

**3.04 BACKFILLING METHODS****A. Carefully compacted Trench Backfill and Pipe Zone Bedding materials. Furnish where indicated on Drawings, specified for trench embedment conditions and for compacted backfill conditions up to 12 IN above top of pipe:**

1. Comply with the following:
  - a. Place backfill in lifts not exceeding 6 IN (compacted thickness).
  - b. Hand place, shovel slice, and pneumatically tamp all carefully compacted backfill around the haunches of the pipe.
  - c. Observe specific manufacturer's recommendations regarding backfilling and compaction.
  - d. Compact each lift to specified requirements.

- B. Trench Backfill:
  - 1. Perform in accordance with the following:
    - a. Place backfill in lift thicknesses capable of being compacted to densities specified. Maximum lift thickness shall be 6 IN (compacted thickness) provided Contractor sufficiently demonstrates his means and methods are capable of obtaining the required compaction. Otherwise, maximum lift thickness shall be 6 IN (compacted thickness) at the discretion of the Engineer.
    - b. Observe specific manufacturer's recommendations regarding backfilling and compaction.
    - c. Avoid displacing joints and appurtenances or causing any horizontal or vertical misalignment, separation, or distortion.
    - d. Legally dispose of all excavated material that is not reused as backfill.
- C. Backfill at utility crossings:
  - 1. When a new utility crosses under an existing utility, backfill at least the final 12-inches of trench beneath the invert of the existing utility with CDF to provide a uniform bedding for the existing utility.
  - 2. Provide forms to control quantity of CDF that is used as backfill. Remove forms after CDF has set sufficiently to stand on its own without the forms.
  - 3. Allow CDF to set sufficiently to support the weight and compaction efforts of the remaining backfill placing and compacting the remaining backfill material.
- D. Water flushing for consolidation is not permitted.

**3.05 COMPACTION**

- A. General:
  - 1. Place and assure bedding, backfill, and fill materials achieve an equal or higher degree of compaction than undisturbed materials adjacent to the work.
  - 2. In no case shall degree of compaction below minimum compactions specified be accepted.

## B. Compaction requirements:

1. Unless noted otherwise on the Drawings or more stringently by other Specification sections, comply with following minimum trench compaction criteria:

## a. Pipe Zone Bedding:

Location	Compaction Density
All locations	90 percent of maximum dry density by ASTM D1557

## b. Trench Backfill:

Location	Compaction Density
Under pavements, roadways, surfaces, structures, sidewalks within highway right-of-ways	95 percent of maximum dry density by ASTM D1557
Under turfed, sodded, plant seeded, nontraffic areas	90 percent of maximum dry density by ASTM D1557

**3.06 FIELD QUALITY CONTROL**

- A. Testing: The Owner has retained a testing laboratory to perform the soils testing. The Contractor shall:
  1. Assure that the Owner has immediate access for testing of all soils related work.
  2. Ensure excavations are safe for testing personnel.
  3. Pay for all costs associated with retesting associated with "Failing" tests.

**END OF SECTION**

THIS PAGE INTENTIONALLY LEFT BLANK

## **SECTION 31 23 43 EARTHWORK**

### **PART 1 : GENERAL**

#### **1.01 SUMMARY**

- A. Section includes:
1. Structure excavation and backfilling necessary for the construction of all structures associated with the project, except linear utility trenching, which is addressed in Section 31 23 33 – Trenching, Backfilling, and Compacting for Utilities.
  2. Excavation of earthwork of whatever consistency encountered.
  3. Over-excavation of materials, as directed by the Engineer.
  4. Handling of excavated materials and associated cleanup.
  5. Providing and placing various fill materials in accordance with the Contract Documents.
  6. Compacting existing and imported materials suitable for the anticipated loadings.
  7. Foundation requirements for roadways and other asphalt-surfaced areas are addressed in Section 32 12 16 – Hot Mix Asphalt (HMA) Paving.

#### **1.02 REFERENCES**

- A. ASTM International (ASTM):
1. C33, Standard Specification for Concrete Aggregates.
  2. C131, Standard Test Method for Resistance to Degradation of Small-Size Coarse Aggregate by Abrasion and Impact in the Los Angeles Machine.
  3. C136, Standard Test Method for Sieve Analysis of Fine and Coarse Aggregates.
  4. D1241, Standard Specification for Materials for Soil-Aggregate Subbase, Base, and Surface Courses, with Gradation Requirements modified per this Specification.
  5. D1557, Standard Test Methods for Laboratory Compaction Characteristics of Soil Using Modified Effort (56,000 ft-lbf/ft<sup>3</sup> (2,700 kN-m/m<sup>3</sup>)).
  6. D3786, Standard Test Method for Bursting Strength of Textile Fabrics-Diaphragm Bursting Strength Tester Method.
  7. D4253, Standard Test Methods for Maximum Index Density and Unit Weight of Soils Using a Vibratory Table.
  8. D4254, Standard Test Methods for Minimum Index Density and Unit Weight of Soils and Calculation of Relative Density.
  9. D4632, Standard Test Method for Grab Breaking Load and Elongation of Geotextiles.

10. D6938, Standard Test Methods for In-Place Density and Water Content of Soil and Soil-Aggregate by Nuclear Methods (Shallow Depth).
- B. Standard Specifications for Road, Bridge, and Municipal Construction, 2021 by the Washington State Department of Transportation.
- C. Reference Document: Geotechnical Engineering Report, Bangor-Keyport Force Main Replacement, Kitsap County, Washington, September 3, 2020, Landau Associates.

### 1.03 QUALITY ASSURANCE

Registered professional engineer licensed in the State of Washington for design of shoring systems or other excavation safety plans in accordance with Section 31 41 00 – Excavation Support Systems.

### 1.04 DEFINITIONS

Excavation: All excavation will be defined as unclassified.

### 1.05 SUBMITTALS

- A. Submit in accordance with the provisions of Section 1-06 – Control of Material.
- B. Product technical data including:
  1. Acknowledgement that products submitted meet requirements of standards referenced.
  2. Manufacturer's installation instructions.
- C. Certifications.
- D. Test reports:
  1. Sieve analysis for all borrow materials in accordance with ASTM C136.
  2. Laboratory density test data (maximum modified proctor) in accordance with ASTM D1557 on all materials subject to compaction testing.
  3. Material source data.
  4. If the source or quality of any materials changes during construction, the Contractor shall furnish additional test reports to the Owner for review and acceptance prior to the use of the different material.
- E. At least 20 Working Days before dewatering is started, the Contractor shall submit a Construction Dewatering Plan to the Engineer. The Dewatering Plan shall include:
  1. Details regarding method, installation, and construction of the dewatering system including:
    - a. Numbers and types of equipment.
    - b. Soil permeability.

- c. Anticipated and potential effects on adjacent structures and properties.
  - d. Depth, locations, and conveyance capacity of equipment.
  - e. Water discharge locations.
  - f. Necessary permits and requirements for water discharge.
  - g. An estimate of advance time to dewater the excavation prior to work in the excavation when necessary.
  - h. Such other information to verify acceptable control and performance.
2. The Construction Dewatering Plan shall be prepared by a registered professional hydrogeologist or engineer licensed in the State of Washington; and shall be reviewed by the Engineer before the Contractor begins excavation.

## PART 2 : PRODUCTS

### 2.01 MATERIALS

- A. Trench Backfill:
  1. As indicated on the Drawings.
    - a. Gravel Borrow: in accordance with Section 9-03.14(1) of the Standard Specifications. During wet weather construction, the amount of fines (material passing a U.S. No. 200 sieve) shall not exceed 5 percent by dry weight, based on a wet sieve analysis of that portion passing the ¾-inch sieve.
- B. Foundation Material:
  1. As indicated on the Drawings.
    - a. Foundation Material Class A: in accordance with Section 9-03.17 of the Standard Specifications.
- C. Crushed Surfacing Base Course (CSBC): in accordance with Section 9-03.9(3) of the Standard Specifications.
- D. Crushed Surfacing Top Course (CSTC): in accordance with Section 9-03.9(3) of the Standard Specifications.
- E. Geotextile Filter Fabric:
  1. Nonwoven type.
  2. Equivalent opening size: 50-100 (U.S. Standard Sieve).
  3. Permeability coefficient (cm/second): 0.07 minimum, 0.30 maximum.
  4. Grab strength: 90 LBS minimum in either direction in accordance with ASTM D4632 requirements.

5. Mullen burst strength: 125 psi minimum in accordance with ASTM D3786 requirements.

## PART 3 : EXECUTION

### 3.01 PROTECTION

- A. Protect existing surface and subsurface features on-site and adjacent to site as follows:
  1. Provide barricades, coverings, or other types of protection necessary to prevent damage to existing items indicated to remain in place.
  2. Protect and maintain bench marks, monuments, or other established reference points and property corners:
    - a. If disturbed or destroyed, replace in accordance with WAC 332-120: Survey Monuments-Removal or Destruction, at own expense to full satisfaction of Owner and controlling agency.
  3. Verify location of utilities:
    - a. Omission or inclusion of utility items does not constitute nonexistence or definite location.
    - b. Secure and examine local utility records for location data.
    - c. Take necessary precautions to protect existing utilities from damage due to any construction activity. Service lines from the main utility may not be shown on the Drawings. The Contractor shall anticipate the need to work around these service lines.
    - d. Repair damages to utility items at own expense.
    - e. In case of damage, notify the Engineer and affected utility company at once so that required protective measures may be taken.
  4. Maintain free of damage, existing sidewalks, structures, and pavement, not indicated to be removed:
    - a. Any item known or unknown or not properly located that is inadvertently damaged shall be repaired to original condition.
    - b. All repairs to be made and paid for by the Contractor.
  5. Provide full access to public and private premises, fire hydrants, street crossings, sidewalks, and other points as designated by the Owner to prevent interruption of travel.
  6. Maintain stockpiles and excavations in such a manner to prevent inconvenience or damage to structures on-site or on adjoining property.
  7. Avoid surcharge or excavation procedures which can result in heaving, caving, or slides.
- B. Salvageable items: carefully remove items to be salvaged, and store on Owner's premises unless otherwise directed.



- C. Dispose of waste materials, legally, off site:
  - 1. Burning, as a means of waste disposal, is not permitted.

### 3.02 SITE EXCAVATION AND GRADING

- A. The work includes all operations in connection with excavation, borrow, construction of fills and embankments, rough grading, and disposal of excess materials in connection with the preparation of the site(s) for construction of the proposed facilities.
- B. Excavation and grading:
  - 1. Perform as required by the Drawings.
  - 2. Drawings may indicate both existing grade and finished grade required for construction of the Project:
    - a. Stake all units, structures, piping, roads, parking areas, and walks and establish their elevations.
    - b. Perform other layout work required.
    - c. Replace property corner markers to original location if disturbed or destroyed.
  - 3. Preparation of ground surface for embankments or fills:
    - a. Before fill is started, scarify to a minimum depth of 6 IN in all proposed embankment and fill areas.
    - b. Where ground surface is steeper than one vertical to four horizontal, plow surface in a manner to bench and break up surface so that fill material will bind with existing surface.
  - 4. Protection of finish grade:
    - a. During construction, shape and drain embankment and excavations.
    - b. Maintain ditches and drains to provide drainage at all times.
    - c. Protect graded areas against action of elements prior to acceptance of work.
    - d. Reestablish grade where settlement or erosion occurs.
- C. Borrow:
  - 1. Provide necessary amount of approved fill compacted to density at least equal to that indicated in this Section.
  - 2. Include cost of all borrow material in original proposal.
  - 3. Fill material to be approved by the Engineer prior to placement.
- D. Construct embankments and fills as required by the Drawings:
  - 1. Construct embankments and fills at locations and to lines of grade indicated:

- a. Completed fill shall correspond to shape of typical cross section or contour indicated regardless of method used to show shape, size, and extent of line and grade of completed work.
2. Provide approved fill material which is free from roots, organic matter, trash, frozen material, and stones having maximum dimension greater than 6 IN:
  - a. Ensure that stones larger than 4 IN are not placed in upper 6 IN of fill or embankment.
  - b. Do not place material in layers greater than 8 IN loose thickness.
  - c. Place layers horizontally and compact each layer prior to placing additional fill.
3. Compact by sheepsfoot, pneumatic rollers, vibrators, or by other equipment as required to obtain specified density:
  - a. Control moisture for each layer necessary to meet requirements of compaction.

### 3.03 USE OF EXPLOSIVES

Blasting with any type of explosive is prohibited.

### 3.04 FIELD QUALITY CONTROL

- A. The Owner will retain a qualified independent testing laboratory to perform the laboratory and field tests.
- B. Do not include in bid price the cost of inspection services indicated herein as being performed by the independent testing laboratory.
- C. Moisture density relations, to be established by the independent testing laboratory, are required for all materials to be compacted.
- D. Extent of compaction testing will be as necessary to assure compliance with the Specifications.
- E. Give a minimum of 24 HR advance notice to the Engineer when ready for compaction or subgrade testing and inspection.
- F. Should any compaction density test or subgrade inspection fail to meet specified requirements, perform corrective work as necessary.
- G. Pay for all costs associated with corrective work and retesting resulting from failing compaction density tests.

### 3.05 COMPACTION DENSITY REQUIREMENTS

- A. Obtain approval from the Engineer with regard to suitability of soils and acceptable subgrade prior to subsequent operations.
- B. Provide dewatering system necessary to successfully complete excavation, compaction, and construction requirements.

- C. Remove frozen, loose, wet, or soft material; and replace with approved material as directed by the Engineer.
- D. Stabilize subgrade with well-graded granular materials as directed by the Engineer.
- E. Assure, by results of testing, that compaction densities comply with the following requirements:

1. Sitework:

Location	Compaction Density
Under Paved Areas, Sidewalks, and Piping	95 percent per ASTM D1557
Unpaved Areas, Pipe Backfill	90 percent per ASTM D1557

2. Structures:

Location	Compaction Density
Inside of structures under foundations, under equipment support pads, under slabs-on-grade, and scarified existing subgrade under fill material	95 percent per ASTM D1557
Outside structures next to walls, piers, columns, and any other structure exterior member	90 percent per ASTM D1557

**3.06 EXCAVATION, FILLING, AND BACKFILLING FOR STRUCTURES**

A. General:

- 1. In general, work includes, but is not limited to, excavation for structures and retaining wall, removal of underground obstructions and undesirable material, furnishing and placing fill and backfill, and compaction of subgrade and backfill.
- 2. Obtain fill and backfill material necessary to produce grades required:
  - a. Materials and source to be approved by the Engineer.
- 3. In this Section, the word "foundations" includes footings, base slabs, foundation walls, mat foundations, grade beams, piers, and any other support placed directly on soil.
- 4. In the paragraphs of this Section, the word "soil" also includes any type of rock subgrade that may be present at or below existing subgrade levels.

B. Excavation requirements for structures:

- 1. General:
  - a. Do not commence excavation for foundations for structures until the Engineer approves:

- 1) The removal of topsoil and other unsuitable and undesirable material from existing subgrade.
  - 2) Density and moisture content of site area compacted fill material meets requirements of the Specifications.
  - 3) Site surcharge or mass fill material can be removed from entire construction site or portion thereof.
  - 4) Surcharge or mass fill material has been removed from construction area or portions thereof.
- b. Engineer grants approval to begin excavations.
2. Dimensions:
    - a. Excavate to elevations and dimensions indicated or specified.
    - b. Allow additional space as required for construction operations and inspection of foundations.
  3. Removal of obstructions and undesirable materials in excavation includes, but is not limited to, removal of old foundations, existing construction, unsuitable subgrade soils, expansive type soils, and any other materials which may be concealed beneath present grade, as required to execute work indicated on Drawings:
    - a. If undesirable material and obstructions are encountered during excavation, remove material, and replace as directed by the Engineer.
  4. Level off bottoms of excavations to receive foundations, floor slabs, equipment support pads, or compacted fill:
    - a. Remove loose materials and bring excavations into approved condition to receive concrete or fill material.
    - b. Where compacted fill material must be placed to bring subgrade elevation up to underside of construction, compact existing subgrade to density stated in this Section before fill material is placed thereon.
    - c. Do not carry excavations lower than shown for foundations except as directed by the Engineer.
    - d. If any part of excavations is carried below required depth without authorization, maintain the excavation and start the foundation from the excavated level with concrete of the same strength as required for the superimposed foundation; no extra compensation will be made to the Contractor therefore.
  5. Make excavations large enough for working space, forms, dampproofing, waterproofing, and inspection.
  6. Notify the Engineer as soon as excavation is completed in order that subgrades may be inspected:

- a. Do not commence further construction until subgrade under compacted fill material, under foundations, under floor slabs-on-grade, under equipment support pads, and under retaining wall footings have been inspected and approved by the Engineer as being free of undesirable material, being of compaction density required by this specification, and being capable of supporting the allowable foundation design bearing pressures and superimposed foundation, fill, and building loads to be placed thereon.
  - b. Engineer shall be given the opportunity to inspect subgrade below fill material both prior to and after subgrade compaction.
  - c. Place fill material, foundations, retaining wall footing, floor slabs-on-grade, and equipment support pads as soon as weather conditions permit after excavation is completed, inspected, and approved and after forms and reinforcing are inspected and approved.
  - d. Before concrete or fill material is placed, protect approved subgrade from becoming loose, wet, frozen, or soft due to weather, construction operations, or other reasons.
7. Dewatering:
- a. Refer to Geotechnical Engineering Report for Construction Dewatering considerations and on-site soils information.
  - b. The Contractor is fully responsible for controlling groundwater.
  - c. Excavations shall be kept free of water as necessary to advance the project and maintain safe working conditions.
  - d. The Contractor shall control surface run-off to prevent entry or collection of water in excavations.
  - e. The control of groundwater shall prevent softening of the bottom of excavations, or formations of “quick” or heaving conditions, or “boils”.
  - f. Dewatering systems shall be designed and operated to prevent any removal or flowing of native soils or previously placed fill soils.
  - g. In the event the subgrade is compromised as a result of the Contractor’s dewatering methods, the Contractor shall be fully responsible for restoring the integrity of the subgrade to the satisfaction of the Engineer.
  - h. Disposal of the water shall not cause injury to public or private property, or nuisance to the public, or degradation of the natural or built environment.
  - i. Sufficient pumping and power equipment in good working condition shall be available at all times for all emergencies, including power outage, and competent personnel shall be available at all times for the operation of the dewatering system.

- j. Water discharge locations shall comply with required permits from Kitsap County, other local jurisdictions, State, and Federal agencies, as appropriate.
  - k. The Contractor shall discharge dewatering water in accordance with the terms of the Construction Stormwater General Permit and any other applicable project permits. No sediment shall present in the discharge water and the discharge volume/rate shall be within the permit's allowable capacity. All sediment removal measures shall be at the Contractor's expense.
  - l. If sediment-laden water is being discharged, the Contractor shall immediately cease dewatering discharge upon notification by the Owner or Engineer. The Contractor shall anticipate that the dewatering discharge may have to be discontinued for a period of time, especially during wet weather conditions. No claim may be made if the conditions require that the dewatering discharge be temporarily discontinued.
  - m. The Contractor shall do whatever is necessary to eliminate or minimize sediment transport during dewatering operations. If sediments or solids are present in the dewatering water, the Contractor shall employ best management practices (BMPs) to remove settleable and suspended solids as required to meet permit or water quality requirements.
  - n. The dewatering system shall be designed to prevent loss of foundation support to adjacent structure, underground installation, improvement, or the sides of an excavation. The dewatering system shall be installed and operated so that the groundwater level outside the excavation is not drawn down to the extent that would damage or endanger adjacent structure, underground installation, sidewalk, pavement, other improvement, or property.
  - o. The groundwater table shall be lowered to a minimum of 2 feet below the bottom of any excavation.
  - p. The return of groundwater to its static level shall be performed in such a manner as to maintain the undisturbed state of the natural foundation soils and supported soils, prevent disturbance of compacted bedding and backfill, and prevent flotation or movement of structures and utilities.
  - q. Costs associated with dewatering excavations and controlling groundwater will be paid under bid item "Dewatering" in accordance with Section 1-09.6.
  - r. Keep dewatering system in operation until dead load of structure exceeds possible buoyant uplift force on structure.
8. Subgrade stabilization:
- a. If subgrade under foundations, fill material, floor slabs-on-grade, or equipment support pads is in a frozen, loose, wet, or soft condition before construction is placed thereon, remove frozen, loose, wet, or soft material and replace with approved Foundation Material as directed by the Engineer.

- b. Provide compaction density of replacement material as stated in this Section.
  - c. Method of stabilization shall be performed as directed by the Engineer.
  - d. Do not place further construction on the repaired subgrades, until the subgrades have been approved by the Engineer.
9. Protection of structures:
- a. Prevent new and existing structures from becoming damaged due to construction operations or other reasons.
  - b. Prevent subgrade under new and existing foundations from becoming wet and undermined during construction due to presence of surface or subsurface water or due to construction operations.
10. Shoring:
- a. Provide Excavation Support Systems in accordance with Section 31 41 00 – Excavation Support Systems.
  - b. Shore, sheet pile, slope, or brace excavations as required to prevent them from collapsing.
  - c. Remove shoring as backfilling progresses but only when banks are stable and safe from caving or collapse.
11. Drainage:
- a. Control grading around structures so that ground is pitched to prevent water from running into excavated areas or damaging structures.
  - b. Maintain excavations free of water where foundations, floor slabs, equipment support pads, or fill material are to be placed.
  - c. Provide pumping required to keep excavated spaces clear of water during construction.
  - d. Should any water be encountered in the excavation, notify the Engineer.
  - e. Provide free discharge of water by trenches, pumps, wells, well points, or other means as necessary and drain to point of disposal that will not damage existing or new construction or interfere with construction operations.
12. Frost protection:
- a. Do not place fill material on frozen ground.
  - b. When freezing temperatures are expected, do not excavate to full depth indicated, unless fill material can be placed immediately after excavation has been completed and approved.
  - c. Protect excavation from frost if placing of fill is delayed.
- C. Fill and backfill below base slabs, and piping:

1. General:

- a. Subgrade to receive fill or backfill shall be free of undesirable material as determined by the Engineer and compacted to density specified herein.
  - b. Surface may be stepped by at not more than 12 IN per step or may be sloped at not more than 2 percent.
  - c. Do not place any fill or backfill material until subgrade under fill or backfill has been inspected and approved by the Engineer as being free of undesirable material and compacted to specified density.
2. Obtain approval of fill and backfill material and source from Engineer prior to placing the material.
  3. Fill and backfill placement:
    - a. Prior to placing fill and backfill material, optimum moisture and maximum density properties for proposed material shall be obtained from the Engineer.
    - b. Place fill and backfill material in 6 IN maximum compacted thickness lifts as necessary to obtain required compaction density. 12 IN compacted thickness lifts may be used if the Contractor proves the required compaction density is being obtained.
    - c. Compact material by means of equipment of sufficient size and proper type to obtain specified density.
    - d. Use hand operated equipment for filling and backfilling next to walls.
    - e. Do not place fill and backfill when the temperature is less than 40 DegF and when subgrade to receive fill and backfill material is frozen, wet, loose, or soft.
    - f. Use vibratory equipment to compact granular material; do not use water.
- D. Filling and backfilling outside of structures.
1. This paragraph of this Section applies to fill and backfill placed outside of structures above bottom level of both foundations and piping but not under paving.
  2. Provide material as approved by the Engineer for filling and backfilling outside of structures.
  3. Fill and backfill placement:
    - a. Prior to placing fill and backfill material, obtain optimum moisture and maximum density properties for proposed material from the Construction Manager or Engineer.
    - b. Place fill and backfill material in 6 IN compacted thickness lifts as necessary to obtain required compaction density. 12 IN compacted thickness lifts may be used if the Contractor proves the required compaction density is being obtained.
    - c. Compact material with equipment of proper type and size to obtain density specified.



- d. Use only hand operated equipment for filling and backfilling next to walls and retaining walls.
  - e. Do not place fill or backfill material when the temperature is less than 40 DegF and when subgrade to receive material is frozen, wet, loose, or soft.
  - f. Use vibratory equipment for compacting granular material; do not use water.
- E. Backfilling outside of structures under piping or paving:
- 1. When backfilling outside of structures requires placing backfill material under piping or paving, the material shall be placed from bottom of excavation to underside of piping or paving at the density required for fill under piping or paving as indicated in this Section.
  - 2. This compacted material shall extend transversely to the centerline of piping or paving a horizontal distance each side of the exterior edges of piping or paving equal to the depth of backfill measured from bottom of excavation to underside of piping or paving.
  - 3. Provide special compacted bedding or compacted subgrade material under piping or paving as required by other Sections for the Project.

**END OF SECTION**

THIS PAGE INTENTIONALLY LEFT BLANK

**SECTION 31 25 14**  
**SOIL EROSION AND SEDIMENT CONTROL**

**PART 1 : GENERAL**

**1.01 SUMMARY**

- A. Section includes:
  - 1. Soil erosion and sediment control.

**1.02 REFERENCES**

- A. Erosion control standards: Standards and Specifications for Soil Erosion and Sediment Control in Developing Areas by the United States Department of Agriculture (USDA), Soil Conservation Service, College Park, Maryland.
- B. Standard Specifications for Road, Bridge, and Municipal Construction, 2021 by the Washington State Department of Transportation.

**1.03 QUALITY ASSURANCE**

Designate and have a Certified Erosion and Sediment Control Lead (CESCL) onsite at all times.

**PART 2 : PRODUCTS**

**2.01 MATERIALS**

- A. Straw bales, twine tied.
- B. Pipe riser and barrel: 16 GA corrugated metal pipe (CMP) of size indicated.
- C. Stone for stone filter: 2 IN graded gravel or crushed stone.
- D. Grass Seed: annual ryegrass.
- E. Catch basin inserts: Conform to Section 8-01.3(9)D of the Standard Specifications. Inserts shall have straps to facilitate removal and cleaning of inserts and shall have a minimum storage capacity of 0.5 cf. Above inlet covers and inlet grate covers are not allowed.
- F. Check Dams: Conform to Section 8-01.3(6) of the Standard Specifications.
- G. Mulch shall be wood cellulose fiber with guar gum or accepted equal as a soil binder.

**PART 3 : EXECUTION**

**3.01 PREPARATION**

- A. Prior to general stripping of topsoil and excavating:
  - 1. Install perimeter filter fabric fence, as shown on the Drawings.

2. Excavate and shape sediment basins and traps.
  3. Construct pipe spillways and install stone filter, if required.
  4. Machine compact all berms, dikes and embankments for basins and traps.
  5. Install straw bales where required:
    - a. Provide two stakes per bale.
    - b. First stake angled toward previously installed bale to keep ends tight against each other.
  6. Install catch basin inserts, filter fabric fence, coir logs, and other erosion control measures, as necessary.
- B. Construct sediment traps, where indicated on Drawings or as needed, during rough grading as grading progresses.
- C. Temporarily seed slopes and topsoil stockpiles:
  1. Rate: 1/2 LB/1000 SF.
  1. Re-seed as required until good stand of grass is achieved.
- D. Temporary erosion and sedimentation control measures shall be in place and functional before land disturbing activities take place.

### 3.02 DURING CONSTRUCTION PERIOD

- A. Maintain erosion and sedimentation control measures:
  1. Inspect regularly especially after rainstorms.
  2. Repair, augment, or replace damaged or missing items.
- B. After rough grading, sow temporary grass cover over all exposed earth areas not draining into sediment basin or trap.
- C. Provide necessary swales and dikes to direct all water towards and into sediment basins and traps.
- D. Do not disturb existing vegetation (grass and trees):
  1. The Contractor shall over-seed areas at a rate of 5 pounds per 1,000 square feet where the Contractor's actions have compromised the erosion and sedimentation control functions of the existing vegetation.
  2. Areas subsequently disturbed by the Contractor's operations shall be reseeded.
- E. Remove sediment out of basins, traps, and catch basin inserts, when capacity has been reduced by 50 percent.
- F. Remove sediment from behind bales to prevent overtopping.

- G. Topsoil and fine grade slopes and swales, etc.: Seed and mulch as soon as areas become ready. Apply mulch at 200 pounds per acre minimum.
- H. All construction areas shall be properly protected and stabilized with erosion and sedimentation control measures as construction progresses.

**3.03 NEAR COMPLETION OF CONSTRUCTION**

- A. Remove basins, dikes, traps, etc.
- B. Grade to finished or existing grades.
- C. Fine grade all remaining earth areas, then seed and mulch.
- D. Clean catch basins and stormwater conveyance piping.

**END OF SECTION**

THIS PAGE INTENTIONALLY LEFT BLANK

**SECTION 31 41 00  
EXCAVATION SUPPORT SYSTEMS**

**PART 1 : GENERAL**

**1.01 SUMMARY**

Work covered in this Section includes requirements for cribbing and shoring to be used for demolition, structural excavations, and trench safety.

**1.02 SUBMITTALS**

- A. Submit in accordance with the provisions of Section 1-06 – Control of Materials.
- B. Submit the following:
  - 1. Certification that all excavation support system design work has been performed under the direction of a professional engineer licensed by the State of Washington.
  - 2. Structural shoring design and support calculations for all shoring system that will be used for this project. The shoring design shall be stamped by a professional engineer licensed in the State of Washington.
  - 3. Shoring contractor qualifications.
- C. Informational submittals:
  - 1. Trench shield (trench box) certification, if employed:
    - a. Specific to Project conditions.
    - b. Re-certified if members become distressed.
    - c. Certification by registered professional structural engineer, registered in the State of Washington.
    - d. Engineer is not responsible to, and will not, review and approve.
  - 2. Trench safety plan and/or trench shoring drawing:
    - a. Trench Safety Plan and/or trench shoring drawings submittal is required only as evidence that plans and drawings have been prepared if required by authorities having jurisdiction.
    - b. Engineer is not responsible to, and will not, review and approve.

**1.03 REFERENCES**

- A. WAC 296-155 – Safety Standards for Construction Work.
- B. RCW Chapter 39.04.180 – Trench Excavations – Safety Systems Required.
- C. RCW Chapter 49.17 Washington Industrial Safety and Health Act.
- D. Standard Specifications for Road, Bridge, and Municipal Construction, 2021 by the Washington State Department of Transportation.

- E. Reference Document: Geotechnical Engineering Report, Bangor-Keyport Force Main Replacement, September 3, 2020, Landau Associates.

**1.04 QUALITY ASSURANCE**

- A. The shoring contractor shall:
  - 1. Specialize in earth retention/construction as its primary business.
  - 2. Be fully experienced and properly qualified, licensed, equipped, organized and financed to perform the shoring and excavation support work.
  - 3. Have successfully completed at least five projects of similar scope and shoring/earth retention requirements in similar soil and groundwater conditions in the last five (5) years.

**1.05 SYSTEM REQUIREMENTS**

- A. Cribbing, sheeting, and shoring shall be designed by a qualified person and meet the requirements of WAC 296-155.
- B. The Contractor shall be exclusively responsible for providing the services of the competent person and registered professional engineer, as referenced in WAC 296-155-650, relating to excavation, trenching, and shoring. Representatives of the Owner and the Engineer shall not be required to perform the roles of competent person or registered professional engineer as defined in WAC 296-155-650.
- C. Adequate sheeting, shoring, bracing, sloping, dewatering, or other methods of sustaining the stability of the floor and walls of the excavation shall be utilized as necessary to support the excavation under loading conditions that exist or arise during construction.
- D. Means and methods shall protect and not adversely impact the structures or facilities, existing or constructed. Dewatering, if employed in conjunction with a shoring system, shall be in accordance with Sections 31 23 43 – Earthwork.

**PART 2 : PRODUCTS**

NOT USED

**PART 3 : EXECUTION**

**3.01 CRIBBING, SHEETING, AND SHORING**

- A. Install and maintain shoring, sheeting, bracing, and sloping necessary to support the sides of the excavation and to prevent movement that may damage adjacent facilities, delay the work, or endanger life and health. Conform to the requirements of WISHA and other applicable governmental regulations and agencies.
- B. The Contractor shall be solely responsible for making and maintaining excavations in a safe manner.



- C. Proper design and installation of the shoring and associated dewatering systems, method of construction, and monitoring and protection of the structure excavations, shoring, existing structures, and facilities are the responsibility of the Contractor. The Contractor shall ensure the integrity of existing structures and facilities are maintained and that appropriate construction techniques are employed at all times to protect existing, as well as installed, structures and facilities. In the event shoring becomes unstable or surface settlement occurs, the Contractor shall immediately implement corrective measures and notify the Engineer. The Contractor shall be solely liable for shoring and associated dewatering systems necessary to support the excavations under loading conditions that may exist or arise during construction.
- D. Use any combination of shoring and overbreak, tunneling, boring, sliding trench shield, or other method allowed by the applicable local, State, and Federal safety codes.
- E. Carefully reconsolidate the bedding and side support behind a movable box prior to placing backfill.
- F. Sheet piling and timbers in trench and other excavations shall be withdrawn in a manner so as to prevent subsequent settlement of structures or pipe, or additional backfill loading that might overload the pipe. Reconsolidate bedding/backfill to the satisfaction of the Engineer.
- G. Leave in place those portions of cribbing and sheeting extending below the crown elevation of the pipe, unless the bedding and side support can be reconsolidated to the satisfaction of the Engineer.
- H. Where shoring or movable trench shields extend below the top of a pipe and are to be removed, locate at least one pipe diameter away from the pipe. They may be located closer only if the Contractor demonstrates to the Engineer's satisfaction a means of reconsolidation.
- I. If a movable box is used in lieu of cribbing or sheeting, and the bottom cannot be kept above the springline of the pipe, the bedding or side support shall be carefully reconsolidated behind the movable box prior to placing initial backfill.
- J. Where removal of sheeting would result in damage to adjacent utilities or other property, the Engineer may order all or a portion of sheeting to be cut off and left in place.
- K. Do not use horizontal strutting below the barrel of a pipe.
- L. Do not use the pipe as support for trench bracing.
- M. Damages resulting from improper shoring and failure to shore shall be the sole responsibility of the Contractor.

### 3.02 TRENCH EXCAVATION SAFETY SYSTEMS

- A. Protect utility trench excavation in excess of 4 feet in depth with a safety system conforming to the referenced requirements.

- B. The Contractor's trench safety system shall be designed by a qualified person and meet the referenced requirements.

**3.03 PAYMENT**

Costs associated with providing, installing, and maintaining adequate excavation support systems as specified herein shall be included in and paid under bid item "Excavation Support Systems".

**END OF SECTION**

**SECTION 32 12 16**  
**HOT MIX ASPHALT (HMA) PAVING**

**PART 1 : GENERAL**

**1.01 SUMMARY**

- A. Section includes:
  - 1. Temporary and permanent hot mix asphalt (HMA) paving.

**1.02 REFERENCES**

- A. Federal Specifications (FS):
  - 1. TT-P-115F, Paint, Traffic (Highway, White and Yellow).
- B. Standard Specifications for Road, Bridge, and Municipal Construction, 2021 by the Washington State Department of Transportation.
- C. Construction Manual: Washington State Department of Transportation, 2021 as amended to date.
- D. AASHTO T 209 – Standard Method of Test for Theoretical Maximum Specific Gravity and Density of Hot Mix Asphalt (HMA) Paving Mixtures.

**1.03 MISCELLANEOUS**

Should conflicts arise between Standard Specifications of government agencies mentioned herein and these Contract Documents, these Contract Documents shall govern.

**1.04 SUBMITTALS**

- A. Submit in accordance with the provisions of Section 1-06 – Control of Materials.
- B. Product technical data including:
  - 1. Acknowledgement that products submitted meet requirements of standards referenced.
  - 2. Manufacturer's installation instructions.
- C. HMA concrete design mix.

**PART 2 : PRODUCTS**

**2.01 MATERIALS**

- A. HMA:
  - 1. Asphalt Binder: PG 58-22 as set forth in Section 9-02.1(4) of the Standard Specifications.

2. Hot Mix Asphalt: HMA Class ½-inch as set forth in Section 9-03.8(2) of the Standard Specifications.
  3. Aggregate: Per Section 9-03.8 of the Standard Specifications for HMA Class 1/2-inch.
- B. Tack coat: AR-4000W, per Section 9-02.1(4) of the Standard Specifications.
- C. Line paint:
1. Nonreflective.
  2. White.
  3. FS TT-P-115F.

## 2.02 MIXES

- A. Mix shall comply with Section 5-04 of the Standard Specifications:
1. Equivalent single axle load (ESAL) shall be > 3 million and less than 10 million.

## PART 3 : EXECUTION

### 3.01 PREPARATION

- A. Subgrade preparation:
1. Prepare using methods, procedures, and equipment necessary to attain required compaction densities, elevation, and section.
  2. Scarify and re-compact top 6 IN of fills and embankments that will be under paved areas.
  3. Remove soft or spongy areas and replace with aggregate material.
  4. Compact subgrade to 95 percent relative density per ASTM D1557.
  5. Assure moisture content of structural fill is within 3 percent of its optimum to achieve required compaction density.
  6. Following compaction, trim and roll to exact cross section:
    - a. Check with approved grading template.
  7. Coordinate with the Engineer for density tests on subgrade to determine that subgrade complies with the Specification.
- B. Aggregate course:
1. Place material in not more than 6 IN thick layers.
  2. Spread, shape, and compact all material deposited on the subgrade during the same day.
  3. Compact to 95 percent relative density per ASTM D1557.
- C. Loose and foreign material: remove loose and foreign material immediately before application of paving.

- D. Appurtenance preparation:
  - 1. Adjust manholes, inlets, valve boxes and any other utility appurtenances to design grade after new HMA pavement has been installed.

### 3.02 INSTALLATION

- A. Construct to line, grade and section as shown on the Drawings and in accordance with the Standard Specifications.
  - 1. Affected roads shall be excavated for installation of sanitary sewer force main, IPS force main, gravity sewer, and associated structures, as shown on the drawings. Trenches within HMA-paved areas shall be restored in accordance with the Drawings, see Detail 3 Sheet R-29. After completion of pipe installation and trench restoration, the Contractor shall perform HMA grinding/removal and overlay in accordance with the Drawings, see Detail 3 Sheet R-29.
- B. Spread prime coat uniformly on compacted aggregate top course at rate of 0.05 to 0.10 GAL per square yard.
- C. Compact each lift to a minimum of 92 percent of the maximum density, as determined by AASHTO Test Method T 209:
  - 1. Level of compaction shall be determined as the average of not less than 5 nuclear density gauge tests taken on the day the mix is placed at randomly selected locations within each lot.
  - 2. Quantity represented by each lot shall be no greater than a single day's production or approximately 400 tons, whichever is less.
  - 3. Cores taken within 48 hours of placement of the mix may be used as an alternative to the nuclear density gauge tests.
  - 4. HMA pavement not meeting the prescribed minimum density standard shall be removed and replaced with satisfactory material at the Contractor's expense.
- D. All joints of asphalt concrete pavement shall be sealed with asphalt cement. The asphalt paint binder, or tack coat, shall conform in all respects to Section 5-04 of the Standard Specifications. After pavement is in place, all joints shall be sealed with hot asphalt cement (AR 4000W).
- E. Temporary HMA pavement:
  - 1. HMA pavements that are installed and subsequently removed by the Contractor.
  - 2. Install to a minimum depth of one inch over 3 inches of crushed surfacing top course.
  - 3. Provide a suitable and safe driving surface for traffic and pedestrians by compacting with a roller or vibratory plate to provide a smooth driving surface. "Wheel-rolling" is not acceptable.
  - 4. Remove and dispose of temporary HMA pavement prior to installing

- permanent HMA pavement.
5. Install temporary HMA pavement over all trenches in streets that currently have asphalt paving. Maintain temporary HMA pavement until permanent HMA pavement is installed.
  6. Temporary HMA pavement that fails due to rutting, spalling, or other means, as determined by the Engineer, shall be repaired by the Contractor at no cost to the Owner.
- F. Line painting:
1. Thoroughly clean surfaces which are to receive paint.
  2. Make completely dry before paint is applied.
  3. Do not paint until a minimum of five (5) days has elapsed from time surface is completed:
    - a. A longer period may be required if directed by the Engineer.
    - b. Provide temporary striping as needed.
  4. Do not apply paint over wet surfaces, during wet or damp weather, or when temperature is below 40 DegF.
  5. Markings and striping shall be applied to match existing.

### 3.03 FIELD QUALITY CONTROL

- A. Comply with Section 5-04 of the Standards Specifications.
- B. Composite pay factors will not be used.
- C. No deductions will be made for the weight of asphalt binder, blending sand, mineral filler, or any other component of the mixture.
- D. If HMA is rejected or subsequently removed as a function of the Contractor's means and methods for obtaining the final grades and thicknesses shown on the Drawings, the material removed will not be included in the measured quantity being paid.

### END OF SECTION

**SECTION 32 91 19**  
**TOPSOILING AND FINISHED GRADING**

**PART 1 : GENERAL**

**1.01 SUMMARY**

- A. Section includes:
  - 1. Topsoiling and finished grading.
- B. Location of work: All areas within limits of grading and all areas outside limits of grading which are disturbed in the course of the work.

**1.02 REFERENCES**

- A. ASTM International (ASTM):
  - 1. D1557, Standard Test Methods for Laboratory Compaction Characteristics of Soil Using Modified Effort (56,000 ft-lbf/ft<sup>3</sup> (2,700 kN-m/m<sup>3</sup>)).
  - 2. E11, Standard Specification for Woven Wire Test Sieve Cloth and Test Sieves.

**1.03 SUBMITTALS**

- A. Submit in accordance with the provisions of Section 1-06 – Control of Materials.
- B. Project Data: test reports for furnished topsoil.

**1.04 PROJECT CONDITIONS**

Verify amount of topsoil stockpiled and determine amount of additional topsoil, if necessary to complete work.

**PART 2 : PRODUCTS**

**2.01 MATERIALS**

- A. Topsoil:
  - 1. Two-way soil mix of 50% composted organic mulch and 50% sand, sandy loam, or silty sand high in organic content blended with compost.
  - 2. Well combined, free of weeds, rocks debris and other deleterious materials that will not pass through a 7/16-inch sieve.
  - 3. Shall not contain sawdust or other fresh wood byproducts.
  - 4. Acceptable Sources:
    - a. Peninsula Topsoil and Landscape Supplies, Belfair, WA.
    - b. North Mason Fiber, Belfair, WA.
    - c. Cedar Grove Compost Company, Maple Valley, WA.
    - d. Or accepted equal.

**2.02 TOLERANCES**

Finish grading tolerance: 0.1 foot plus/minus from required elevations.

**PART 3 : EXECUTION****3.01 GENERAL**

- A. Proceed as rapidly as the Site becomes available, consistent with normal seasonal limitations for soil preparation work.
- B. Subgrade to consist of native soils or placed soils that will provide plants with nutrients, positive drainage and appropriate particle sizes that promote long-term plant health and stability.
- C. Immediately notify the Engineer of poorly draining or unacceptable drainage conditions within landscape areas that will affect the health and maturation of new plantings.
- D. Soil moisture content:
  - 1. Do not work soil when moisture content is so great that excessive compaction will occur. A person walking across subgrade or planting soil shall not depress soil more than one inch.
  - 2. Do not work soil when it is so dry that dust will form in the air or when clods will not break readily.
- E. Keep streets, sidewalks, and project area clean and free from debris.
- F. Protect prepared soils from disruption by other work and construction activities.

**3.02 SUBGRADE PREPERATION**

- A. Clear existing grass within limits of areas to be sodded or hydroseeded.
- B. Loosen grade to a depth of 4 inches.
- C. In areas with existing tree roots or within tree driplines, hand cultivate soil to a depth of 4 inches taking care not to damage existing root systems.

**3.03 ROUGH GRADE REVIEW**

Prior to placing topsoil, the Engineer shall review subgrades for acceptance.

**3.04 SOIL PREPARATION AND PLACING TOPSOIL**

- A. Place sufficient depth of planting soil to achieve finish grade as indicated on the Drawings and to provide allowance for one inch depth of settlement.
- B. Place planting soil mix to a depth of 2 inches.
- C. Roll and compact planting soil at 85 percent maximum density per ASTM D1557.



**3.05 FINISH GRADE**

- A. Provide finished surface free of stones, sticks, or other material 1 inch or more in any dimension.
- B. Provide finished surface smooth and true to required grades.
- C. Restore stockpile area to condition of rest of finished work.

**3.06 ACCEPTANCE**

- A. Upon completion of topsoiling, obtain the Engineer's acceptance of grade and surface.
- B. Make test holes where directed to verify proper placement and thickness of topsoil.

**END OF SECTION**

THIS PAGE INTENTIONALLY LEFT BLANK

## **SECTION 32 92 30 GRASS PAVERS**

### **PART 1 : GENERAL**

#### **1.01 DESCRIPTION OF WORK**

- A. Section Includes: Supply and installation of interlocking plastic grass pavers, set over crushed rock base, including leveling, coursing, cutting and infilling honeycomb voids with imported topsoil.
- B. Related Sections:
  - 1. Section 32 91 19 – Topsoiling and Finished Grading
  - 2. Section 31 23 43 – Earthwork

#### **1.02 SUBMITTALS**

- A. In accordance with the requirements of Section 01 33 00, submit the following data:
  - 1. Layout Drawings: Submit drawing indicating proposed layout of grass pavers
  - 2. Grass Paver product data and 2'x2' material sample

#### **1.03 SEQUENCING AND SCHEDULING**

- A. Review installation procedures, and coordinate work with other trades.
- B. Install grass paver work after the specified base has been placed and compacted to the approved grades and slopes.
- C. Maintain site circulation, barricades, and barriers required for a safe construction site.

#### **1.04 MAINTENANCE AND GUARANTEE**

- A. Grass paver installation shall be guaranteed, materials and workmanship, for five years from the date of final acceptance.
- B. Grass pavers shall be maintained from installation through one year after final project acceptance
- C. Maintenance shall include: Resetting pavers to finished grade which have settled or rutted greater than 1 inch in 10 feet in any direction from establish slopes.

### **PART 2 : PART 2: MATERIALS**

#### **2.01 GRASS PAVERS**

- A. NDS EZ Roll Grassroad Pavers:
  - 1. Dimensions: 1-1/4" thick x 4' W x 24' L or 150' L rolls

2. Interlocking plastic pavers with 2" hexagonal honeycomb voids for filling with planting soils
  3. Compression load rating of 52, 600 pounds per square foot empty
  4. Local distributor Frank J. Martin, Co., Seattle, WA (800) 654-1786
- B. Staking Materials: 6" steel staples for Jute Matting or Techline supplied by HD Fowler Company, Inc. (800) 487-5290, or approved alternate

## 2.02 SETTLING MATERIALS

- A. Gravel borrow material(s) in accordance with Drawings and as specified in Section 31 23 43.

## PART 3 : EXECUTION

### 3.01 EXAMINATION

- A. General: Examine areas where installation of grass pavers will occur with Owner's Representative. Verify that conditions are satisfactory for installation and comply with manufacturer's requirements and those specified in this Section.

### 3.02 GRASS PAVER INSTALLATION

- A. Earthwork and other construction that involves large and/or heavy construction equipment needs to be accomplished prior to installation of grass pavers to help protect the pavers from potential damage. Installation of grass pavers shall therefore occur as late as possible in the construction. Construction traffic, especially heavily loaded vehicles, tracked or large wheeled equipment needs to be limited to the extent possible on the installed pavers. Contractor shall caution equipment operators and personnel to use care when operating on the installed pavers. In no case shall heavy construction vehicles or equipment operate on the pavers during inclement weather/wet conditions. Contractor will be responsible for any damage and repair to the pavers due to construction traffic.
- B. General:
1. Site Clearing per Section 31 10 00
  2. Prepare and compact subgrade 31 23 43
  3. Install pavers in accordance with manufacturer's requirements and as specified herein.
  4. Minimize cutting to maximize interlocking connections between units for stability per approved submitted layout drawing
  5. Use power driven saws for cutting of units with clean and straight edges.
  6. Place cut pavers to continue honeycomb pattern dimensions between units.
  7. Interlock and stake pavers to secure over compacted gravel base material.
  8. Finish grade top of pavers shall not vary more than 1/2" when tested with a 10' straight edge.

9. Fill honeycomb paver voids with topsoil and hydroseed per Section 32 90 00 – Planting

**3.03 CLEANING**

- A. Leave finished installation clean and free of cracked, chipped, broken, or defective grass pavers.

**END SECTION 32 92 30**

THIS PAGE INTENTIONALLY LEFT BLANK

**SECTION 33 05 16  
UTILITY STRUCTURES**

**PART 1 : GENERAL**

**1.01 SUMMARY**

A. Section includes:

1. Precast concrete manholes, vaults, and accessories.

**1.02 REFERENCES**

A. ASTM International (ASTM):

1. A48, Standard Specification for Gray Iron Castings.
2. A615, Standard Specification for Deformed and Plain Carbon-Steel Bars for Concrete Reinforcement.
3. C150, Standard Specification for Portland Cement.
4. C443, Standard Specification for Joints for Concrete Pipe and Manholes Using Rubber Gaskets.
5. C478, Standard Specification for Circular Precast Reinforced Concrete Manhole Sections.
6. C857, Standard Practice for Minimum Structural Design Loading for Underground Precast Concrete Utility Structures.
7. C858, Standard Specification for Underground Precast Concrete Utility Structures.
8. C923, Standard Specification for Resilient Connectors Between Reinforced Concrete Manhole Structures, Pipes, and Laterals.
9. C1244, Standard Test Method for Concrete Sewer Manholes by the Negative Air Pressure (Vacuum) Test Prior to Backfill.
10. C1619, Standard Specification for Elastomeric Seals for Joining Concrete Structures.

B. AASHTO Standard Specification for Highway Bridges.

C. ACI 318 Building Code Requirements for Structural Concrete.

D. Standard Specifications for Road, Bridge, and Municipal Construction, 2021 by the Washington State Department of Transportation.

E. Reference Document: Geotechnical Engineering Report, Bangor-Keyport Force Main Replacement, Landau Associates, September 3, 2020

**1.03 SUBMITTALS**

- A. In accordance with the provisions of Section 1-06 – Control of Materials, submit the following:
1. Product technical data including:
    - a. Catalog data.
    - b. Acknowledgement that products submitted meet requirements of standards referenced.
    - c. Manufacturer's installation instructions.
  2. Fabrication and/or layout drawings:
    - a. Include detailed diagrams of precast structures showing typical components and dimensions, reinforcements, weights, and other details.
    - b. Itemize, on separate schedule, sectional breakdown of each catch basin, manhole, and vault structure with all associated components and refer to drawing identification number or notation.
    - c. Indicate knockout elevations for all piping entering each precast structure coordinated with the location and elevation of pipe and conduit shown on the Drawings.
  3. Cement concrete mix design.
  4. Reinforcement design based on specified Design Requirements in Paragraph 1.04.
  5. Buoyancy design calculations for precast structures.
  6. Structural design calculations based on the Basis of Rational Design, stamped by a professional engineer licensed by the State of Washington.
  7. Manhole vacuum test results.

**1.04 DESIGN REQUIREMENTS**

- A. Normal weight concrete per ASTM standards for underground precast concrete utility structures.
- B. Minimum concrete cover over reinforcement shall not be less than that required by ACI 318, if greater than ASTM C858 unless shown otherwise noted on the Drawings.
- C. Minimum Loading Requirements:
1. Loading assumptions, unless noted otherwise on the Drawings, shall conform to ASTM C857 except as follows:
    - a. Top slabs shall be designed for A-16 (HS20-44) Loading OR 250 PSF Live Loading, whichever is greater, unless otherwise indicated.



- b. Wall and bottom slab design and uplift calculations shall include hydrostatic pressure from groundwater, with a design groundwater elevation equal to the ground surface, as recommended by the Geotechnical Engineering Report, Bangor-Keyport Force Main Replacement prepared by Landau Associates, dated September 3, 2020
- c. Live loads and weights for post-installed items such as internal piping, pumps, valves, sewage, concrete grout fill, etc. shall not be included in the buoyancy calculations.
- d. Buoyancy calculations shall have a minimum factor of safety equal to 1.5.
- e. Buoyancy resistance forces may include the following:
  - 1) Weight of the precast structure.
  - 2) Weight of the cast-in-place top slab shown on the Drawings within a footprint of 1 foot beyond outside edge of the precast structure.
  - 3) Buoyant soil weight within the footprint of the extended base slab.
  - 4) Buoyant soil weight within a wedge defined from the outside of the extended base slab to ground surface assuming a soil friction angle of 20 degrees. Frictional resistance forces between the concrete and soil may not be used for resistance in the buoyancy calculations.

## PART 2 : PRODUCTS

### 2.01 ACCEPTABLE MANUFACTURERS

- A. Subject to compliance with the Contract Documents, the following manufacturers are acceptable:
  - 1. Precast Concrete Structures:
    - a. Oldcastle Precast (basis of design).
    - b. Or accepted equal.
  - 2. Watertight Manhole Frame and Cover (30-inch):
    - a. MwayPro.
    - b. Or accepted equal.
  - 3. Watertight Manhole Frame and Cover (24-inch):
    - a. EJ Group International.
    - b. Or accepted equal.
  - 4. Manhole Steps:
    - a. Bowco Industries, Inc.
    - b. Parson Environmental Products, Inc.
    - c. American Step Company, Inc.

- d. Or accepted equal.
  5. Premolded Joint Compound:
    - a. Kent Seal, Hamilton Kent.
    - b. Or accepted equal.
  6. Exterior Joint Wrap:
    - a. ConSeal CS-212, Concrete Sealants, Inc.
    - b. WrapidSeal, CCI Pipeline Systems.
    - c. Or accepted equal.
- B. Submit request for substitution in accordance with Section 1-06.6 Substitution.

## 2.02 MANHOLE AND VAULT STRUCTURE COMPONENTS

- A. Manhole components:
1. Reinforcement: ASTM C478.
  2. Concrete Mix:
    - a. Constructed with Portland ASTM C150, Type I/II cement blend for a marine environment.
  3. Minimum wall and base thicknesses: As determined by precast manufacturer based on specified Design Requirements, minimum if noted on the Drawings.
  4. Provide the following components for each manhole structure as appropriate:
    - a. Extended base (precast) with integral bottom section. Extended base dimensions and thickness shall be determined by precast manufacturer to accommodate the specified Design Requirements in Paragraph 1.04. Extended base shall be designed to the minimum dimensions noted on the Drawings.
    - b. Precast bottom section(s).
    - c. Precast barrel section(s), minimized to reduce number of joints.
      - 1) Joints shall be located a minimum 6 inches from a pipe penetration, cast or cored.
    - d. Precast eccentric transition section.
    - e. Precast adjuster ring(s).
    - f. Precast concrete transition section.
  5. Provide manhole section with minimum inside dimensions as shown on the Drawings.
  6. Interior and exterior surfaces shall be sacked and/or ground smooth to provide a uniform surface.
  7. Wrap all joints with 8-inch-wide Exterior Joint Wrap after installation.

8. Coat interior and exterior surfaces of manholes and wet wells as specified in Section 09 96 00 – Painting and Protective Coatings.
  9. Manholes shall be vacuum tested and visually inspected as specified in this Section.
- B. Vaults components:
1. Reinforcement: ASTM C478.
  2. Concrete Mix:
    - a. Constructed with Portland ASTM C150, Type I/II cement blend for a marine environment.
  3. Minimum dimensions: As indicated on the Drawings.
  4. Minimum wall thicknesses: As determined by precast manufacturer based on specified Design Requirements, minimum if noted on the Drawings.
  5. Provide the following components for each vault:
    - a. Extended base (precast) with integral bottom section. Extended base dimensions and thickness shall be determined by precast manufacturer to accommodate the specified Design Requirements in Paragraph 1.04. Extended base shall be designed to the minimum dimensions noted on the Drawings.
      - 1) Pitch floor at a minimum of 1/4-inch per foot to drain during casting or with high strength non-shrink grout.
    - b. Precast bottom section(s).
    - c. Precast riser section(s), minimized to reduce number of joints.
      - 1) Joints shall be located a minimum 6 inches from a pipe penetration, cast or cored.
    - d. Precast solid wall and solid center construction.
    - e. Aluminum ladder as shown on the Drawings.
  6. Interior and exterior surfaces shall be sacked and/or ground smooth to provide a uniform surface.
  7. Wrap all joints with 8-inch-wide Exterior Joint Wrap after installation.
  8. Coat interior and exterior surfaces of vaults as specified in Section 09 96 00 – Painting and Protective Coatings.
- C. Pipe penetrations in precast structures:
1. Pipe and conduit penetrations larger than 6 inches in diameter shall be precast with the structure in the location and elevations shown on the Drawings. All penetrations below 6 inches in diameter may be core drilled in the field by the Contractor if allowed by the precast manufacturer.
- D. Watertight Manhole Frame and Cover:
1. Frame and cover shall meet load rating EN124:1994 C250.

2. Material shall be fiberglass composite for both frame and cover.
  3. Clear opening shall be 30-inches.
  4. Cover shall be watertight with a replaceable gasket.
  5. All component parts shall be resistant to chemical attack, fuels, salt and water or a combination of the above over the lifespan of the cover and frame. Surface discoloration is acceptable in service.
  6. Manhole frame and cover shall be cast into a precast flat top of diameter and thickness shown on the Drawings.
- E. Manhole Steps:
1. Injection molded copolymer polypropylene conforming to ASTM D4101 that encapsulates a 1/2-inch diameter, Grade 60 ASTM A615 deformed steel reinforcing bar.
  2. Meet ASTM C478, ASTM C497, AASHTO M199, and OSHA related standards.
  3. Steps provided in accordance with ASTM C478 shall conform to ANSO 14.3.
- F. Joint Treatment:
1. Joints of precast manholes and vault base, riser, and top sections:
    - a. Manholes: rubber gaskets conforming to ASTM C443.
    - b. Other Joints: Rubber gasket or self-sealing mastic type waterstop, Greenstreak, Lockstop, or accepted equal to provide a watertight seal on the interior.
- G. High Strength, Non-shrink Grout: as specified in Section 03 60 00 – Grout.

## **PART 3 : EXECUTION**

### **3.01 MANHOLE AND VAULT CONSTRUCTION**

- A. Precast concrete manholes and vaults with integral bottom section:
1. Ensure accurate vertical placement and leveling prior to placement.
  2. Provide vertical alignment tolerance of maximum 1 IN horizontal to 10 FT vertical.
  3. Prechannel manhole inverts with a semi-circular bottom conforming to the inside contour of the adjacent sewer sections:
    - a. Channels shall be prechanneled with concrete extending to the spring line of the largest diameter pipe penetration or higher.
    - b. Shape inverts accurately and smoothly to minimize turbulence and give them a steel trowel finish.
    - c. For changes in direction of the sewer and entering branches into the manhole, make a circular curve in the manhole invert of as large a radius as manhole size will permit.

- d. Slope benches from the manhole wall towards the channel at a minimum of 1/4 inch per foot.
  4. Build each manhole and vault structure to dimensions shown on the Drawings and at such elevation that pipe sections built into wall of manhole will be true extensions of line of pipe.
  5. Provide reinforcing around openings for pipe or duct penetrations per ACI 318.
- B. For all horizontal mating surfaces between concrete and concrete or concrete and metal, seal joints with rubber gaskets in a manner similar to pipe joints conforming to ASTM C443 or ASTM C1619. In addition, all joints shall be provided with an Exterior Joint Wrap.
- C. Manholes and vaults shall be watertight.
- D. Pipe to manhole connections as shown on the Drawings.
- E. Joints in structures shall be located a minimum 6 inches from a pipe penetration, cast or cored.
- F. Set and adjust frame and cover final 6 IN (minimum) to 18 IN (maximum) to match finished pavement or finished grade elevation using precast adjuster rings.

### 3.02 FIELD QUALITY CONTROL

- A. Manhole Testing:
1. Vacuum Testing:
    - a. Prior to backfill and interior coating installation, vacuum test manholes and wet well system according to ASTM C1244.
  2. Visual Inspection Testing:
    - a. After backfill and release of groundwater to its natural level, observe inside of structure for groundwater infiltration. Contractor shall perform corrective action as approved by the Engineer to eliminate any infiltration, at no cost to the Owner.
- B. Precast reinforced concrete risers and tops shall be subject to rejection on account of failure to conform to any Specification requirements. In addition, individual sections of risers and tops may be rejected because of any of the following reasons:
1. Fractures or cracks passing through shell, except for single end crack not exceeding depth of joint.
  2. Defects indicating imperfect proportioning, mixing, and molding.
  3. Surface defects indicating honeycombed or open texture.
  4. Damaged ends where such damage would prevent making satisfactory joint.
  5. Manhole steps out of line or not properly spaced.

6. Visible infiltration.
7. Internal diameter of section varying more than 1 percent from nominal diameter.
8. Any continuous crack having surface width of 0.01 inch or more and extending for length of 12 inches or more, regardless of position.

**END OF SECTION**

**SECTION 33 05 23.13  
HORIZONTAL DIRECTIONAL DRILLING**

**PART 1: GENERAL**

**1.01 SUMMARY**

- A. The Contractor shall furnish all labor, equipment, and materials necessary to install pipe by horizontal directional drilling (HDD) as indicated on the Project Drawings.
- B. The Contractor shall be responsible for installing the pipe within the tolerances specified herein for line and grade.
- C. The horizontal directional drilling will be completed in three phases. The first phase consists of drilling a small diameter pilot bore along the designed directional path as shown on the plans. The second phase consists of enlarging the pilot hole to a diameter suitable for installation of the pipe. Third phase is pulling the pipe through the enlarged hole.

**1.02 REFERENCE SPECIFICATIONS, CODES, AND STANDARDS**

- A. Installation of Pipelines by Horizontal Directional Drilling, Pipeline Research Committee, American Gas Association, PR-227-9424, April 1995.
- B. Horizontal Directional Drilling Good Practices Guidelines, 2008, 2004, 2001, HDD Industry Consortium, 300pp.
- C. API Bulletin 13D, 1985. Bulletin on the Rheology of Oil-Well Drilling Fluids, Second Edition, Dallas, Texas, American Petroleum Institute.
- D. API Recommended Practice 13B-1, 1990. Standard Procedures for Field Testing Water-Based Drilling Fluids, First Edition, Dallas, Texas, American Petroleum Institute.
- E. ASTM F 1962 Standard Guide for Use of Maxi-Horizontal Directional Drilling for Placement of Polyethylene Pipe or Conduit Under Obstacles, Including River Crossings
- F. Installation of Pipelines Beneath Levees Using Horizontal Directional Drilling, US Army Corps of Engineers, Waterways Experiment Station, Final Report, CPAR-GL-98-1, April 1998.
- G. API Specification 13A, 1993. Specification for Drilling Fluid Materials, Fifteenth Edition, Dallas, Texas. American Petroleum Institute.
- H. IADC Drilling Manual, 1992. Eleventh Edition, Houston, Texas, International Association of Drilling Contractors.

- I. Pressure Pipeline Design for Water and Wastewater, American Society for Civil Engineers, 2<sup>nd</sup> ed., 1992.
- J. Tables for Hydraulic Design of Pipes and Sewers, American Society for Civil Engineers, 5<sup>th</sup> ed., 1990.
- K. AWWA Manual of Water Supply Practices M55 – PE Pipe – Design and Installation. The installation for HDPE pipe shall meet all of the requirements of the latest edition of this manual.
- L. Compliance with NSF/ANSI Standard 61

### 1.03 SUBMITTALS

- A. Submit the following information in accordance with the provisions of Section 1-06 – Control of Materials, providing sufficient detail to allow the Engineer to determine whether the proposed equipment, materials, and procedures meet the Contract requirements. Review and acceptance of the Contractor’s Submittals by the Engineer shall not be construed in any way as relieving the Contractor of its responsibilities under this Contract. All submittals requiring Engineer acceptance shall be submitted not less than four (4) weeks prior to commencing any HDD activities. The Contractor shall provide his initial submittal of the following items within ten (10) calendar days of award of contract: pipe data sheets, proposed equipment, and an HDD schedule.
- B. Pre-Qualifications: Submit written documentation of the HDD Subcontractor, Superintendent and key personnel experience in accordance with 1.05A.
- C. Submit evidence of OSHA certification for the Site Safety Representative or Competent Person.
- D. Shop Drawings: The drawings shall include all equipment, equipment setup areas including layout of both work areas on either end of the bore and for both phases of work (i.e. initial pilot boring and reaming, and remobilization of drill rig for pipe pullback), pipe layout areas, and any excavations or mud recirculating pits. The Contractor shall confirm that all operations shall be completely contained within the work area limits shown on the Drawings.
- E. Schedule: The Contractor shall submit a detailed schedule showing all major construction activities and durations, including starting and completion dates. The schedule shall be updated at least every 2 weeks or more frequently, and include:
  - 1. “One call” utility locate requests and visual confirmation of all crossing utilities and all parallel utilities within twenty (20) feet laterally of the bore centerline.
  - 2. Site preparation.
  - 3. Mobilization and setup.
  - 4. Pilot bore drilling.



5. Pre-reaming and reaming.
  6. Layout and fusing of pipe.
  7. Hydrostatic pressure testing of pipe prior to pullback.
  8. Remobilization of drill rig.
  9. Final reaming/swab pass and pullback of pipe.
  10. Hydrostatic pressure testing of pipe after installation.
  11. Annular space grouting.
  12. Cleanup, surface restoration, and demobilization.
- F. Description of Methods, Equipment and Materials: The Contractor shall submit detailed descriptions of all methods, equipment, and materials to be used for the pipeline installation. Descriptions of drilling mix design and fluid additives shall be accompanied by Materials Safety Data Sheets (MSDS) and manufacturers' descriptions. Descriptions of equipment shall include manufacturers' specifications, calibrations, appropriate drawings, photographs, and descriptions of any modifications since manufacture.
- G. Surveying, Equipment and Procedures: The Contractor shall submit records of equipment calibrations and certifications for all equipment used for downhole surveys and tracking of the drill head. Procedures for operating the downhole survey tools shall be described, including measures to verify the accuracy of the equipment readings.
- H. Pipe Filling Methods (Buoyancy Control): The Contractor shall submit methods and procedures for filling the pipe with water during pullback, testing, and annular space grouting. The submittal shall also include methods and procedures for disposal of any water discharged from the filled pipe.
- I. Calculations for Pullback: The Contractor shall submit calculations for pullback loads for the conditions and operating practices anticipated the 12-inch HDPE force main pipeline. All assumptions used in the calculations shall be provided. These calculations shall be made and stamped by a licensed Professional Engineer registered in the State of Washington.
- J. Pipe Stress Calculations: The Contractor shall submit calculations for pipe stresses expected to result from the pullback, bending, buckling loads, earth loads, groundwater loads, break-over stresses during entry into the bore, and any other installation and service loads expected to be exerted on the pipe. All assumptions used in the calculations shall be provided. These calculations shall be made and stamped by a licensed Professional Engineer registered in the State of Washington.
- K. Calculations of Maximum Allowable Drilling Fluid Pressure: The Contractor shall submit calculations identifying the critical downhole drilling fluid pressure that

would cause hydrofracture or inadvertent drilling fluid returns. The calculations shall identify the points along the alignment where the critical pressure would cause hydrofracture to occur. All assumptions used in the calculations shall be provided. These calculations shall be made and stamped by a licensed Professional Engineer registered in the State of Washington.

- L. Inadvertent Returns and Surface Spill Contingency Plan: The Contractor shall submit an Inadvertent Returns and Surface Spill Contingency Plan describing procedures for preventing drilling fluid losses or fluid returns to the surface. The plan shall address roles and responsibilities of involved parties, monitoring, prevention, containment, cleanup, documentation procedures, and observations to be made and plans for containment and cleanup, if spills or hydrofracture occur, including provisions for containment and clean up of an in-stream hydrofracture event. The plan shall also address changes that may be required to Contractor's operations to avoid recurrences.
- M. Rig Capacity: The Contractor shall submit details on the capacity of the drill rig verifying that the pullback capacity is greater than the estimated pullback load calculated and submitted by the Contractor with the factor of safety specified herein.
- N. Soil Separation Plant: The Contractor shall submit details on the pump and cleaning plant. Include dimensions, manufacturer's specifications, pump capacity, and noise rating.
- O. Plans for Disposal of Spoils and Drilling Fluids: The Contractor shall submit plans for disposal of waste materials resulting from the pipeline construction, including drilling fluids, cuttings, waste oil, fuel, discharge water, etc. The Contractor shall identify the disposal site and submit a letter indicating willingness and legal authority to accept the described and anticipated waste products.
- P. Annular Space Grouting: The Contractor shall submit descriptions of methods, equipment, and materials to be used for grouting the bore annulus between the outside diameter of the pipeline and the bore diameter following pipeline pullback and areas where over-excavation, voids, or cavities are created or encountered.
- Q. Contingency Plans for Potential Problems: The Contractor shall submit contingency plans for remediation of potential problems that may be encountered during the drilling operations. The contingency plans shall address the observations that would lead to the discovery of the problem and the methods that would be used to mitigate the problem. Potential problems that shall be addressed include:
  - 1. Natural or man-made obstructions encountered.
  - 2. Utility strike.
  - 3. Loss of circulation.

4. Deviation from planned bore path.
  5. Inability to advance drill or product pipe.
  6. Hydrolock.
  7. Drill or product pipe twisted off or broken off in borehole.
  8. Pipe collapses or pipe deformations exceed maximum allowable tolerances.
  9. Excessive ground settlement.
- R. Safety Plan: The Contractor shall submit a Safety Plan, including the name of the Contractor's Site Safety Representative, emergency telephone numbers for medical facilities, and precautions for handling and disposal of any hazardous or flammable materials. The Safety Plan shall include a code of safe practices and an emergency plan in accordance with OSHA requirements.
- S. The Contractor shall furnish a certified affidavit of compliance for all pipe and other products or materials furnished under this Section. See Section 22 13 10 – HDPE Pipe and Fittings for additional requirements. All expenses incurred in making samples for certification of tests shall be borne by the Contractor.
- T. The following shall be submitted as construction progresses and at the completion of construction:
1. Daily Logs and Records: The Contractor shall submit complete, legible, written daily logs and records as called for in Paragraph 1.05 C of this specification and as directed by the Engineer, by noon of the following day to which the records correspond.
  2. Variations in Plan and Profile: The Contractor shall document any variations between the actual plan and profile of the bore path and the location shown on the Drawings and specifications herein. The Contractor shall notify the Engineer immediately upon discovery of any deviations that exceed design tolerances.
  3. Hydrostatic Pressure Test Records: The Contractor shall submit all hydrostatic pressure test records for all tests within 48 hours of any tests.
  4. Pilot Bore As-Built Profile: The Contractor shall submit an as-built profile of the pilot bore within 48 hours of completion of when the pilot bore has been completed.
  5. As-constructed plan and profile of the bore in AutoCAD format after pipe installation.

**1.04 DEFINITIONS**

- A. Annular Space: The space between the excavated HDD final reamed bore diameter and the installed pipeline.
- B. Drilling Fluid/Mud: A mixture of water, bentonite, and/or polymers continuously pumped to the drilling tool or bit cutting head to facilitate the removal of soil cuttings, and stabilization of the bore. These fluids also cool the cutting tools and lubricate the pipe string.
- C. Drilling Tool/Bit: Any tool or system of tools that excavate at the face of a bore.
- D. Horizontal Directional Drilling: Horizontal Directional Drilling (HDD) is a guided, steerable drilling system used for the trenchless installation of pipes, conduits, and cables. A pilot bore path is excavated in a shallow arc from a surface-launched drill rig. Excavation takes place with fluid assisted cutting from a drilling tool on the drill string. The bore is filled with drilling mud/fluid for stabilization. The bore path is enlarged with subsequent multiple reaming passes until the desired diameter is achieved. The product pipe, conduit, or cable is pulled into the fluid-stabilized bore. As a final step the specified annular space on each end of the pipe is filled with grout.
- E. Inadvertent Drilling Fluid Returns (Hydrofracture): The fracturing or failure of the soil around the bore hole as a result of excessive drilling fluid pressure generally resulting in drilling mud being released to the surface.
- F. Pilot Bore: The action of creating the first guided pass of the HDD process which is then reamed in multiple passes to the size required to allow pullback of the product pipe.
- G. Product Pipe: The pipe that is pulled into the borehole and installed via horizontal directional drilling.
- H. Pullback: That part of the HDD process in which the drill string and product pipe are pulled back through the bore to the entry point.
- I. Pullback Loads: The tensile load (force) applied to a drill string and product pipe during the pullback process.
- J. Tail String: Additional drill pipe connected at the exit point after the pilot bore is completed to ensure a continuous string of drill pipe throughout the entire length of the borehole during reaming and swabbing phases.

**1.05 QUALITY ASSURANCE**

- A. Qualifications and Experience of HDD Contractor and Personnel: The HDD Contractor business entity shall have met the minimum experience qualifications established. The HDD Contractor shall employ skilled, experienced superintendent(s), drillers, and personnel. Contractor personnel shall have met the experience qualifications established herein.
1. Submit a project reference list of at least five separate HDD projects, successfully completed in the last 10 years, that include the following conditions. A minimum of three of the five projects must be in the last 5 years with casing diameters and lengths equal to or larger than those shown in the Plans, in ground conditions similar to those indicated in the project Geotechnical Report, and successfully completed with equipment as prosed for the Work. Include a brief description of each project, casing diameter, length, subsurface conditions, equipment, and the owner's contact person's name and current phone number for each project listed.
  2. On-site supervisors shall have at least 5 years' experience in supervising construction of Work of similar size (diameter and length) and scope to those shown in the Plans and in ground conditions similar to those indicated in the project Geotechnical Report. Experience shall include the direct supervisory responsibility for the on-site construction operations with equipment as proposed for the Work.
  3. Submit qualifications of the engineering designer. Submit documentation that demonstrates qualifications and knowledge for designs and calculations to be performed and submitted.
  4. Machine Operators shall have at least 10 drives successfully completed in the past 8 years. At least two drives with pipe/casing diameters and lengths equal to or larger than those shown in the Plans, in ground conditions similar to those indicated in the project Geotechnical Report, and successfully completed with equipment as prosed for the Work.
- B. The Contractor shall carefully study the plans and specifications applicable to the work involved, notify the Engineer of any irregularities or difficulties, and become familiar with the conditions, nature of excavation, and difficulties involved with horizontal directional drilling at the site of the work.

Failure on the part of the Contractor to properly appraise the factors, conditions and difficulties involved in the performance of the work will not entitle the Contractor to extra compensation of any kind, nor shall it relieve the Contractor of the obligation of executing all details of the work as specified and planned.

- C. Daily Logs and Records: Daily logs and records shall be maintained by the Contractor and shall include drilling lengths, location of drill head, installation loads, drilling fluid pressures and flow rates, drilling fluid losses, inadvertent returns, drilling times required for each pipe joint, any instances of retraction and re-drilling of the pilot bore or segments thereof, and any other relevant observations, including any hard drilling zones, steering problems, circulation

problems, observed settlement, heave, frac-outs, or surface spills. The installation loads shall be measured at the entry point for the entire length for all phases of the pilot bore and any pilot re-bore, and recorded at least once per drill pipe length or every 30 feet, whichever is more frequent. These records shall be maintained and provided daily to the Engineer. During the pilot bore, reaming passes, and pipe pullback the Contractor shall record the following information once per drill pipe or every 30 feet, whichever is more frequent. The information shall be submitted to the Engineer by noon of the day following the shift for which the records were taken.

1. Rate of Penetration
  2. Rotational Torque
  3. Thrust/ Pull forces
  4. Pump Rates
  5. Calculated Depth
  6. Flow (Meter Returns in Suction Line)
  7. The lengths of each drill pipe.
  8. If torque and thrust are recorded as gage pressures, the conversion factors for pound-feet of torque and pounds force of thrust/pullback shall be provided.
- D. The Contractor shall allow access to the Engineer and shall furnish necessary assistance and cooperation to aid the Engineer in observations and data and sample collection, including, but not limited to the following:
1. The Contractor shall allow the Owner, Owner's Representative, and/or Engineer full access to the operator control container prior to, during, and following all HDD operations. This shall include, but not be limited to, providing access to the operator console including visual access to real-time operator control screens, gauges, and indicators during all drilling operations.
  2. The Contractor shall allow the Owner, Owner's Representative, and/or Engineer full access to the slurry separation plant prior to, during, and following all HDD operations. This shall include, but not be limited to, full access to shaker screens, hydrocyclones, conveyor belts, and slurry and spoil holding tanks. The Contractor shall allow the Engineer to collect soil samples from the shaker screens and/or spoil holding tanks on the slurry separation plant a minimum of once per drill pipe, and whenever changes in conditions are observed or suspected.
  3. All work shall be performed in the presence of the Engineer, unless the Engineer has granted prior approval to perform such work in their absence.

- E. The Contractor shall provide written notice to the Engineer at least one (1) week prior to beginning of the major drilling activities, including site mobilization, guidance system setup and pilot bore launch.
- F. Equipment: The Contractor shall provide all equipment, materials, and personnel necessary for completing the installation as shown on the Drawings and specified herein. The equipment and materials shall include but are not limited to:
  - 1. Directional drilling rig with all ancillary equipment, including drill pipe, drilling fluid, cutting tools, reaming bits, swivels, expanders, motors, generator, pumps, hoses, mixing equipment, drilling fluid processing equipment (cuttings separation equipment), downhole survey equipment, fluid pressure and flow rate monitoring equipment, spare parts, pipe handling equipment, crane, backhoe, roller, side boom tractors, control cabin, control equipment, and office equipment.
  - 2. Drilling fluids, water, fuel, lubricant, polymers, or other additives.
  - 3. Any other expendable or reusable materials, supplies, and equipment needed for the installation.
- G. The drilling equipment shall be capable of advancing through the geologic conditions to be encountered at the site as depicted in the geotechnical report and as anticipated by the Contractor.
- H. The drilling fluid shall be designed for the geologic conditions to be encountered at the site as depicted in the geotechnical report and as anticipated by the Contractor.
- I. The capacity of the directional drilling rig used by the Contractor shall be adequate to install the specified pipeline and shall have a minimum pullback capacity of the estimated pullback loads with a safety factor of 2.0.
- J. The pump used by the Contractor shall be adequate to supply the required flow rate and pressures at the anticipated drilling fluid viscosity at all times. Drilling speeds shall not exceed pump capacity.
- K. The drilling system shall include a fluid pump and separation plant that can achieve the rates of drilling fluid pumping, spoil separation, and slurry cleaning required by the Contractor to achieve planned production rates for the soils anticipated by the Contractor. Shaker screens, hydrocyclones, and centrifuges may be required for efficient separation of spoils.
- L. All spoil and slurry must be contained in trucks, tanks, approved recirculation pits, or other containers at all times. Dumping of spoil or slurry on the ground, discharge into sewers, or discharge into the water bodies shall not be permitted. All spoils shall be transported and disposed of off-site at an approved disposal facility.
- M. Perform all work within work areas shown on the Drawings.

- N. Tolerances: The completed pipeline shall be installed at the line and grade indicated on the drawings. The pilot bore shall be drilled along the path shown on the drawings to the following tolerances:
1. Vertical Tolerance: No greater than one (1) foot above the design bore path.
  2. Horizontal Tolerance: Plus or minus two (2) feet from the design bore path.
  3. Entry and Exit Point Tolerances: The pilot hole shall penetrate the ground surface at the location and angle noted on the drawings.
  4. Any deviation to the radii of curvatures or entry and exit angles shown on the Drawings should be submitted in writing to the Engineer for acceptance.
  5. The Contractor shall advise the Engineer immediately of failure to obtain the tolerances described above.
- O. Pipe rollers and lifters shall be used to help the transition of the product pipe into the bore. The number of pipe rollers and lifters shall be determined by the Contractor and supported by calculations performed by a Professional Engineer registered in the State of Washington. Pipe shall not be dragged on the ground surface.
- P. Surface settlement or heave of the ground surface or utilities and/or other features above the HDD centerlines and within the zone influenced by the HDD construction shall be limited to values that avoid damage. The Contractor shall repair any damage resulting from settlement or heave caused by HDD activities at no additional cost to the Owner. The Contractor shall grout any voids caused by or encountered during drilling.

#### 1.06 PROTECTION OF UNDERGROUND FACILITIES

- A. The Contractor shall be responsible for locating any and all underground facilities regardless of the Engineer's previous efforts in this regard. The Contractor shall be responsible for all losses and repairs to underground facilities resulting from drilling operations. The Contractor shall undertake the following steps prior to commencing drilling operations in a location which might contain underground facilities:
1. The Contractor shall contact the Washington Utility Notification Center at 811 and all other utilities and project owners not covered by this service for the construction area at least two (2) working days before but not more than (10) ten working days before the start of construction of the Work.
  2. Positively locate and stake all existing lines, cables, or other underground facilities including exposing any facilities that are located within ten (10) feet of the designed drill path.



3. Modify drilling practices and downhole assemblies to prevent damage to existing facilities.

**1.07 SAFETY**

It shall be the Contractor's responsibility to see that the work is done in conformance with all applicable Federal, State, and local safety requirements.

**PART 2: PRODUCTS**

**2.01 MATERIALS**

- A. Pipe: The Contractor shall provide and install pipe in accordance with Sections 22 13 10 – HDPE Pipe and Fittings.
- B. Copper clad steel tracer wire shall be direct burial #12 AWG solid (0.0808" diameter) steel core hard drawn extra high strength horizontal directional drill tracer wire, 1,150 lb. average tensile break load, 45 mil high molecular weight, high density blue complying with ASTM-D-1248, 30 volt rating, Copperhead Industries 1245G-EHS-2500, or equal.
- C. Water: The Contractor shall secure a suitable source of water, and shall be responsible for transporting, storing, and disposing of any water required.
- D. Drilling Fluids: The Contractor shall select drilling fluid mixture proportions to ensure continuous circulation, bore stability, reduce drag on the pipe, and completely fill the annular space between the bore and the pipe to control settlement. Management and disposal of drilling fluids shall be the Contractor's responsibility.
- E. Drill Pipe: The Contractor shall provide high quality drill pipe that has been inspected and determined to be adequate for the project requirements. Bent, cracked, or fatigued drill pipes shall not be used. Threads must be in good condition.
- F. Annular Space Grout:
  1. Type V Portland Cement conforming to ASTM C150.
  2. Shall have a slump sufficient to ensure flow through hoses and nozzles to completely fill the annular space between the bore and the product pipe.
  3. Mix design must contain cement, water, and sand at a minimum.
  4. Other admixtures subject to acceptance by the Engineer.
  5. Minimum compressive strength of 100 psi in 24 hours, 300 psi in 28 Calendar Days.

- G. Inadvertent Return Contingency Equipment: Containment and cleanup equipment shall be provided at both entry and exit locations and shall include at a minimum:
1. Heavy weight plastic, gravel filled, and sealed bags.
  2. Geotek filter bags.
  3. Splash board.
  4. Several 5-gallon hard plastic pails.
  5. Heavy duty push brooms and several flat blade shovels.
  6. Silt fence and T post or straw bales.
  7. Straw logs.
  8. Portable pumps.
  9. Hose.
  10. Vacuum truck (available for response within one (1) hour of a hydrofracture event).
  11. In the event of an in-stream hydrofracture event, equipment suitable to provide for in water containment must be available for immediate deployment.

**PART 3: EXECUTION**

**3.01 GENERAL**

- A. The Contractor shall not commence drilling operations until all submittals are received, reviewed, and receive a favorable rating from the Engineer.
- B. The Contractor shall have the equipment listed in the submitted and favorably reviewed Inadvertent Return and Surface Spill Contingency Plan prior to commencing drilling operations.
- C. Unless otherwise provided, the Contractor shall furnish and install all fittings, closure pieces, jointing materials and all appurtenances as shown and as required to provide a complete and workable installation. All fabrication and testing shall comply with the requirements listed herein.

**3.02 WORK STAGING AREA**

- A. Work Staging: The Contractor shall limit staging and work operations to the areas shown on the Drawings, or as otherwise accepted in writing by the Engineer, for storage of equipment and materials, parking, pipe layout, drilling, and other work.

- B. The Contractor will be responsible for constructing required temporary work access and pads for directional drilling in accordance with all applicable permits and local ordinances.
- C. Control of Drilling Fluids: The Contractor shall follow all requirements of the Inadvertent Return and Surface Spill Contingency Plan and control operational pressures, drilling mud weights, drilling speeds, and any other operational factors required to avoid hydrofracture fluid losses into the surrounding formations, and control drilling fluid spillage. This includes any spillages, inadvertent fluid, or slurry returns at entry and exit locations or at any intermediate point. All inadvertent returns or spills shall be promptly contained and cleaned up. The Contractor shall maintain on-site mobile spill containment and removal equipment at the HDD entry and exit location at all times, as per Paragraph 2.1G of this specification. The Contractor shall be capable of quickly containing and removing spills. The Contractor shall immediately notify the Engineer of any inadvertent returns or spills and immediately clean up the inadvertent return or spill.
- D. Disposal of excess drilling fluids is the responsibility of the Contractor and shall be conducted in compliance with all environmental requirements. Drilling fluid disposal procedures proposed for use shall be submitted to the Engineer per Paragraph 1.3O. No procedure may be used which has not been accepted by the Engineer. Control of drilling fluids on the site is very critical. Spills of drilling fluids will not be allowed or permitted.
- E. Combustible Materials: Combustible materials (fuel, oil, lubricants, etc.) shall be stored off-site or in a well-ventilated storage facility removed from the immediate vicinity of the drilling area by at least twenty (20) feet.

### 3.03 MOBILIZATION

- A. The Contractor shall mobilize all equipment, materials, and personnel necessary to construct the pipeline using the HDD process at the locations shown on the Drawings.
  - 1. Entry & Exit Area: Appropriate precautions and measures shall be employed by the Contractor to prevent erosion, surface drainage, and spillage of drilling fluids or other materials that could adversely impact the environmental quality of the site. Silt fences, hay wattles, and hay bales shall be used to line the work area to minimize erosion and contain any spillages or runoff.
  - 2. Pipe Layout Area: Layout area shall be free of stones, wood, debris and obstructions. Pipe rollers shall be provided by the Contractor to facilitate pipe pullback.

**3.04 HORIZONTAL DIRECTIONAL DRILLING**

- A. Bore Tracking and Monitoring:
1. The Contractor shall track bore position using a system compatible with tracking near existing ductile iron utilities such as remote directional walk over tracking system or approved equal. Tracking data shall be continuously monitored and recorded at least once per drill pipe length or at thirty (30) feet or thirty (30) minute intervals during drilling, whichever is most frequent. The completed borehole shall be surveyed with the downhole locating system after all reaming is completed and prior to pullback of the pipe. This information shall be collected and provided to the Owner prior to commencement of pullback.
  2. Deviations between the recorded and design bore path shall be calculated and reported on the daily report. If the deviations exceed the tolerances specified herein, such occurrences shall be reported immediately to the Engineer. The Contractor shall undertake all necessary measures to correct deviations and return to design line and grade, and shall be solely responsible for all work necessary to correct excessive deviations from line and grade, including re-drilling, redesigning connections, and acquiring additional easement, at no additional cost to the Owner and without schedule extension.
  3. Drilling Fluid Pressures and Flow Rates: Drilling fluid pressures and flow rates during pilot bore drilling shall be continuously monitored and recorded by the Contractor
  4. Drilling Fluid Viscosity and Density (Mud Weight): The Contractor shall measure and record drilling fluid viscosity and density at least three (3) times per shift with at least two (2) hours between readings, using calibrated Marsh funnel and mud balance. These measurements shall be included in daily logs submitted to the Engineer.
- B. Location of Entry and Exit Points: Entry and exit points shall be as shown on the Drawings, unless otherwise accepted in writing by the Engineer. The Contractor shall employ licensed, experienced surveyors to locate the entry and exit points, and to establish horizontal and vertical datum for the bore and the pipe layout and fabrication areas.
- C. Pre-reaming and Reaming: The pilot bore shall be pre-reamed and reamed using equipment and methods submitted by the Contractor. The Contractor shall completely ream the bore to the final diameter prior to pullback.
1. The bore shall be reamed to a minimum diameter that is 6 inches greater than the outside diameter of the product pipe.
  2. Tail string shall be employed to ensure that there is a continuous string of drill pipe throughout the entire length of the borehole at all times during the reaming and swabbing phases.

- D. Final Reaming/Swab Pass: The Contractor shall complete a swab pass of the bore upon completion of the final ream and prior to pullback of the pipe. The swab pass reamer shall have an outside diameter that is larger than the product pipe outside diameter.
- E. Hydrostatic Test: The fabricated pipe fused section(s) shall be hydrostatically tested by the Contractor prior to and upon completion of pullback per the procedure provided in Sections 22 13 11 – Piping System and 22 13 00 – Pipe. The Contractor shall repair any defects discovered during these tests and repeat until the pipe passes the test. If the test fails after pullback has been completed, the Contractor shall provide satisfactory remedy to the Owner, including the possible abandonment of installed pipe and installation of a new pipeline, at the Contractor's sole expense with no additional compensation from the Owner.
- F. Tracer Wire:
1. Tracer wire is to be utilized for future locating purposes. A minimum of three separate tracer wires shall be installed with the pipe. The wire shall be secured to the pipe at maximum 10-foot intervals using 2-inch wide duct tape. The tracer wire shall be routed to the blind flanges at either end of the drilled installation to provide access to terminal ends of the wire. All locations of tracer wire intersections shall be soldered to provide electrical continuity and protected from adverse soil conditions with the use of shrink tubes or other approved waterproof connector devices. The result of the tracer wire installation shall be at least one continuous wire circuit electrical isolated from ground.
  2. Leave slack in mainline tracer wire equivalent to a 60-inch diameter loop at each end to facilitate splicing, soldering and waterproofing.
  3. Test for continuity and isolation from ground in the wire after all work has been completed on the test section. Perform intermediate testing after backfilling operations and prior to surface restoration work. Test continuity between access locations by use of a temporary wire connecting test points in-line with an ohmmeter. Measure resistance with an approved ohmmeter that has been property calibrated. The continuity of a test section will be accepted if the resistance of the test section does not exceed 5 ohms for each 500 feet of location wire being tested. Measure isolation from ground with an approved 1,000 volt Megger, applied for one minute. The isolation of a test section will be accepted if the isolation resistance of the test section is at least 10 megaohms.
- G. **PIPE PULLBACK:**
1. Prior to pipe pull back, the pipe shall be subjected to pressure testing. The entire length of pipe shall be pressure tested and visually inspected for leaks prior to pull back. Installation of the pipe will not be allowed until the pipe testing is accepted by the Engineer. The pipe shall be tested a second time after it is in place. See Section 22 13 10 – Piping Systems for pipe pressure testing procedures.

2. The pipe shall be installed by pulling it into the reamed bore hole behind a final reaming tool selected by the Contractor.
  3. The pipe shall be isolated from excessive torsional and axial stresses by a swivel device.
  4. The pipe shall be filled with water in accordance with accepted submittal as it enters the bore to reduce pullback loads.
  5. The Contractor shall monitor and inspect pipe rollers and the method for suspending pipe during the pullback operation.
  6. The Contractor shall monitor and record installation loads once per drill pipe or every 30 feet, whichever is more frequent.
  7. The Contractor shall cease operations if the pipe is damaged and shall remove the damaged pipe from the bore and repair the pipe using the manufacturer's recommended procedure or replace the damaged pipe before resuming installation. The Contractor shall monitor pulling forces to ensure maximum pullback loading of the pipe is not exceeded, and shall notify the Engineer immediately if it has been.
  8. Damage to the pipe resulting from installation or grouting of the annulus is the responsibility of the Contractor, including costs for replacement and labor and materials.
- H. Mandrel: The Contractor shall mandrel the pipeline after installation to check for roundness. A deflection test shall be required for all piping installed. A mandrel shall be pulled through the pipe a minimum of 5 days after the final installation and prior to grouting of the annular space. The deflection of the pipe or conduit shall not exceed 10.0 percent when tested with a mandrel specifically designed for the type and size of pipe installed. Pipe failing the Mandrel test shall be removed and replaced at no cost to the Owner.
- I. Annular Space Grouting:
1. The Contractor shall grout the annular space between the bore and the outer diameter of the pipeline. Grouting shall be completed within 48 hours of completion of the final hydrostatic test.
  2. Grouting procedures shall be in accordance with accepted submittals. The grouting operations shall ensure that the annulus is filled with grout for the 25 feet nearest the entry point and exit point. Grouting may be accomplished using tremie pipes inserted 25 feet into the bore from each end after pipe pullback and the final hydrostatic test is completed. Grout shall be injected in sufficient volume to completely fill the annulus as the tremie pipe is withdrawn. Grouting pressures shall be carefully controlled and monitored to avoid applying excessive pressure to the pipe and to avoid heave or hydrofracture. The grouting apparatus used to complete the annular space grouting shall be capable of delivering grout concurrently at multiple injection points around the pipeline. The

Contractor is responsible for ensuring damage to the pipe does not occur during all grouting operations. The pipe shall remain filled with water during grouting operations.

- J. Site Restoration and Demobilization: The Contractor shall remove all equipment, materials, drilling fluids, muck, waste, and debris from the site and restore the site to its original condition upon completion of the installation. Following construction, the pipes shall be cleaned of all mud, drilling fluid or other materials within the pipe as discussed in other sections of these documents.

END OF SECTION

THIS PAGE INTENTIONALLY LEFT BLANK



**SECTION 33 05 23.32  
CURED-IN-PLACE PIPE**

**PART 1 : GENERAL**

**1.01 SUMMARY**

- A. This Section includes the work necessary to furnish and install UV cured-in-place pipe (CIPP).
- B. The CONTRACTOR shall provide all materials, labor, equipment, and services necessary for handling of sewage flow including bypass pumping, cleaning, and inspection of the existing pipe system, CIPP installation, testing of the lined pipe system, and reconnection of service connections, if any, all as specified herein.
- C. Project locations are shown on the Drawings.

**1.02 CONTRACTOR AND MANUFACTURER QUALIFICATIONS**

- A. The Manufacturer of the CIPP liner shall have a minimum of 200,000 linear feet of CIPP successfully installed in accordance with these specifications. Manufacturer's using standards other than those listed in these specifications shall demonstrate to the satisfaction of the Owner that the standards followed produce a product that is, at a minimum, equal to the quality of product developed using the listed standards.
- B. The CIPP lining Contractor shall have a minimum of five (5) successfully completed projects totaling a minimum of 50,000 lineal feet using the proposed CIPP rehabilitation technology. In addition, the Contractor's project superintendent shall have a minimum of three (3) successfully completed projects totaling a minimum of 25,000 lineal feet using the proposed CIPP rehabilitation technology. The Contractor's identified project superintendent shall be on the project for the duration of the project and shall be available at all times during the CIPP rehabilitation. At least one person on the Contractor's installation crew shall have a minimum of one (1) year of CIPP installation experience and shall be on the project site at all times. The Contractor's identified Lateral Cutting Technician shall have minimum of one (1) year of experience reinstating laterals.
- C. Wastewater collection system rehabilitation products submitted for approval shall be provided with third party test results supporting long-term performance and structural strength of the product. Third party test result data shall be satisfactory to the Engineer. Test samples shall have been prepared so as to simulate the installation methods and trauma of project conditions.

**1.03 REFERENCE STANDARDS**

- A. ASTM International (ASTM):
  - 1. D543, Standard Practices for Evaluating the Resistance of Plastics to Chemical Reagents
  - 2. D790 - Standard Test Methods for Flexural Properties of Unreinforced and Reinforced Plastics and Electrical Insulating Materials
  - 3. 761- Glass Reinforced thermosetting plastics (GRP) pipes

4. D3567 - Standard Practice for Determining Dimensions of "Fiberglass" (Glass-Fiber-Reinforced Thermosetting Resin) Pipe and Fittings
  5. DIN EN 13566-4 - Plastics piping systems for renovation of underground non-pressure drainage and sewerage networks
  6. D638, Standard Test Method for Tensile Properties of Plastics
  7. D790, Standard Test Methods for Flexural Properties of Unreinforced and Reinforced Plastics and Electrical Insulating Materials
  8. D2122, Standard Test Method for Determining Dimensions of Thermoplastic Pipe and Fittings
  9. D2990, Standard Test Methods for Tensile, Compressive, and Flexural Creep and Creep-Rupture of Plastics
  10. D3567, Standard Practice for Determining Dimensions of "Fiberglass" (Glass-Fiber-Reinforced Thermosetting Resin) Pipe and Fittings
  11. F1743, Standard Practice of Rehabilitation of Existing Pipelines and Conduits by the Pulled in Place Installation of Cured-in-Place Thermosetting Resin Pipe (CIPP)
  12. F2019, Standard Practice for Rehabilitation of Existing Pipelines and Conduits by the Pulled in Place Installation of Glass Reinforced Plastic Cured-in-Place (GRP-CIPP) Using the UV-Light Curing Method
  13. F2599, Standard Practice for The Sectional Repair of Damaged Pipe by Means of An Inverted Cured-In-Place Liner
- B. International Organization for Standardization (ISO)
1. ISO 178, Determination of Flexural Properties

#### 1.04 SUBMITTALS

- A. Certification:
1. Certification from the CIPP component manufacturer(s) showing installers are certified and licensed installers.
- B. Personnel:
1. Provide the names of the superintendent(s) on the project. Submit a list of the additional key personnel who will work on this project, including certification of worker training for key personnel involved with installing thermal CIPP (foreman, light train operator, lateral reinstatement operator, etc.). Include a summary of their experience and qualifications related to UV-CIPP installations. Submit letter ensuring that proposed superintendent(s) will be on site for the duration of the CIPP installation.
- C. Lining materials and resins:
1. Manufacturer certification that the CIPP materials are in compliance with the specifications, codes, and standards referenced herein.
  2. Certified test reports demonstrating that the exact resin/liner combination

to be used for this project meets the requirements for initial structural properties (performed in accordance with ASTM F2019, ASTM D638, and ASTM D790 or equivalent as approved) and chemical resistance (per ASTM F2019).

3. Liner system manufacturer's technical data showing complete information on material composition, chemical and physical properties, and dimensions of components of the tube and resin system. Include manufacturer's recommendation for allowable mixing, resin saturation, handling times, temperature control, transportation and storage times and storage requirements, insertion pressures, handling and inserting the liner, curing, trimming, finishing, and data on the maximum allowable stresses and elongation of the tube.
4. Field measurements and pipe sizing calculations which demonstrate CIPP liner has been properly sized to avoid the creation of wrinkles or folds.
5. Structural design calculations and specification data sheets listing all parameters used in the liner design and thickness calculations-based Structural Requirements shown in Section 2.2. All calculations shall be prepared under and stamped by a Professional Engineer Registered in the State of Washington.

D. Installation Plan:

1. Detailed description of the pipe lining installation and curing process including staging and insertion locations and verification of host pipe inside diameter prior to installing CIPP.
2. Include materials and equipment (e.g., UV light train) to be utilized and list of tasks associated with each installation. If applicable, include a contingency curing cycle in the event temperatures fall over or under the liner system manufacturer's recommendations. Identify in the description the type of temperature sensors that will be used, their proposed locations, and recording method and/or equipment.

E. Liner Repair Plan:

1. Liner repair plan, including a detailed description of methods and materials required to repair typical and isolated minor liner damage, such as: installation tears less than 4 inches in length and no more frequent than one in one-hundred linear feet, discrete blisters, areas of pinholes, areas of dry tube, and soft spots. Provide the liner system manufacturer's recommendations for liner repairs. Liner Repair Plan approval is required prior to making each repair.

F. Submit for review, during construction: Curing log, including UV CIPP temperatures, pressures, and times during the curing process to document that a proper cure has been achieved. Curing log shall list at a minimum the light train speed, liner pressures, and temperature of the internal liner surface.

G. Submit for review a CIPP resume of experience including a list of previous CIPP work including 3 project demonstrating minimum qualifications as specified in Section 1.2.

**1.05 QUALITY ASSURANCE**

- A. The finished liner shall be continuous over the entire length of an insertion run between two manholes or access points.
- B. The finished liner shall be free from visual defects such as foreign inclusions, dry spots, delamination, and lifts.
- C. Wrinkles in the finished liner pipe causing a backwater of 1/4-inch or more, or in any way reducing the hydraulic capacity of the pipe, and are not the result of pre-existing conditions, are unacceptable and shall be removed and repaired as directed by the ENGINEER.
  - 1. Methods of repair shall be proposed by the CONTRACTOR and submitted to the ENGINEER for review and approval.

**1.06 WARRANTY**

- A. The Contractor shall warrant each mainline sewer lined with the specified product against defects in materials, surface preparation, lining application, and workmanship for a period of 12 months from the date of final acceptance of the project. The Contractor shall, within one month of written notice thereof, repair defects in materials or workmanship that may develop during said 12-month period. Defects shall be defined as: visible leakage of groundwater through the CIPP system, de-lamination of any portion of the CIPP system as visible from CCTV inspection, or separation of any part of the CIPP system from the host pipe to the extent that the CIPP system inside diameter in the separated area is 90 percent or less of the completed CIPP system inside diameter. The Contractor shall also repair any damage to other work; damage to sewer system components (including pump stations) damages to buildings, houses or environmental damage caused by the backup of the sewer because of the failure of the lining system or repairing of the same at the expense of Contractor, and without cost to the Owner.
- B. Repairs shall include removal of the existing liner and re-lining if possible, or excavation and replacement of the section of pipe where the defect occurs.

**PART 2 : PRODUCTS****2.01 MATERIALS**

- A. Liner Tube
  - 1. The liner tube shall consist of one or more layers of flexible woven material and shall meet the requirements of ASTM F2019-02, Section 5.
  - 2. The liner tube shall be capable of carrying resin, withstanding installation pressures and curing temperatures, and shall be compatible with the resin system used.
  - 3. The liner shall be fabricated to a size that, when installed, will fit the internal circumference of the existing pipe without any annular space between the liner and existing pipe wall.
  - 4. The liner shall be fabricated from materials which, when cured, will be

chemically resistant to and will withstand internal exposure to sewage gases containing quantities of hydrogen sulfide, carbon monoxide, methane, petroleum hydrocarbons, saturation with moisture, diluted sulfuric acid, and other similar chemical reagents.

5. The minimum tube length shall be that deemed necessary by the CONTRACTOR to effectively span the distance from the inlet to the outlet of the respective manholes, or access points, unless otherwise specified. The CONTRACTOR shall verify the lengths in the field before impregnation of the tube with resin. Individual insertion runs may be made over one or more manhole sections as determined in the field by the CONTRACTOR and as reviewed and accepted by the ENGINEER.
6. Prior to insertion, the liner shall be inspected and be free of all visible tears, holes, cuts, foreign materials, and other defects.
7. Prior to insertion, provide data on the maximum allowable stresses and elongation of the tube. The exterior of the manufactured tube shall be marked along its length at regular intervals not to exceed 5 feet. These marks shall be used as a gauge to measure elongation during insertion. Should the overall elongation of a reach exceed 5 percent, the liner tube shall be rejected and replaced.

**B. Resin**

1. Unless otherwise specified, provide a general purpose, unsaturated, thermosetting polyester, vinyl ester, or epoxy resin able to cure in the presence or absence of water, and a catalyst system compatible with the insertion process.
2. The liquid resin shall saturate the liner tube and produce a properly cured liner which is resistant to abrasion due to solids, grit, and sand.
3. Polyester, vinyl ester, or epoxy resin and catalyst system shall comply with the following requirements and that when properly cured meets the requirements of ASTM F2019. Resins created from recycled materials are not allowed.

**C. End seals**

1. Pressure application: Internal mechanical end seals shall be Weko-Seal or approved equal.
2. Gravity application: Sika Hydrotite, Model RS-0520-3.5I, or approved equal.

## **2.02 STRUCTURAL REQUIREMENTS**

- A. The CIPP liner system shall be designed per ASTM F1216 and F2019,
- B. The CIPP liner shall be designed to support hydraulic, soil, and live loads.
- C. The required structural CIPP wall thickness shall be based on the physical properties in Table 33 05 23.32-A below, at a minimum, and upon a fully deteriorated pipe condition.

**Table 33 05 23.32-A  
Physical Properties of CIPP Structural Liner**

Property	Test Method	Minimum Value
Flexural strength	ASTM D790	24,000 psi
Flexural modulus	ASTM D790	1,500,000 psi
Flexural modulus (enhanced)	ASTM D2990	1,125,000 psi
Tensile strength (for pressure pipes only)	ASTM D638	6,000 psi

- D. CIPP shall be designed with the following structural design parameters for the fully deteriorated gravity pipe condition in accordance with the design equations in Paragraph X1.2.2, Fully Deteriorated Gravity Pipe Condition of Appendix X1. - Design Considerations of ASTM F1216-09:
1. Design Safety Factor (N) = 2.0
  2. Retention Factor for Long-Term Flexural Modulus, Min. = 70%
  3. Ovality (calculated from (X1.1 of ASTM F1216-07b) = 2%
  4. Soil density = 120 lbs./cubic foot
  5. Live load = HS-20
  6. Soil modulus = 1,000 psi
  7. Internal Operating Pressure = 30 psi
- E. Additional design parameters, as well as existing pipeline information by pipeline segment or section, are shown in Table 33 05 23.32-B below. This information includes a) section or segment length, b) existing pipe type and nominal inside diameter, c) depth of pipe from ground surface to invert, d) groundwater level below ground surface.

**Table 33 05 23.32-B  
Existing Conditions of Pipelines for CIPP Installation**

Manhole or Section (from-to)	Pipe Length, (center to center of MH's), ft.	Pipe Type	Pipe Nominal Inside Diameter, inches	Pipe Depth to Invert, ft.	Groundwater Level Below Surface, ft.
See Drawings	830	DI	20	5.7	35

Abbreviations:

DI = Ductile Iron Pipe

## PART 3 : EXECUTION

### 3.01 PREPARATION

- A. Sewage Bypass Pumping and/or Sewage Diversion
1. All bypassing required to perform the CIPP operations shall conform to

the requirements set forth in Section 01 59 00 Temporary Sewer Bypass Systems.

- B. Cleaning and Inspection of the Existing Sewer
1. Prior to cleaning of the existing piping, video inspection using a CCTV color camera shall be completed and recorded in DVD format.
  2. Clean, inspect, and confirm the inside diameter of existing piping and determine the condition of each segment of piping to be lined.
  3. The cleaning process shall include the removal of all roots and mineral deposits and other matter.
  4. A video inspection shall be performed after the sewer cleaning operation and point repairs and grouting are completed.
    - a. Video inspection shall be completed in the same direction each time and shall be done with a CCTV color camera recorded in DVD format.
    - b. A copy of the inspection video and written reports from all video inspections shall be provided to the Owner's Representative for review prior to the liner installation.
    - c. See Section 33 30 10.16, TV Inspection of Sewer Pipelines for more specific requirements.
- C. Point Repairs or Removal of Line Obstructions
1. Point repairs or removal of line obstructions shall be performed where video inspections reveal heavy solids, dropped or offset joints, or collapsed pipe that cannot be removed by conventional sewer cleaning equipment and may prevent the proper completion of the lining process.
  2. The Work shall include verifying the location of the point repair, locating all interfering utilities, temporary flow bypassing, traffic control, excavation, shoring, dewatering, pipe repairs or replacements, connections to the existing pipe, backfilling, and surface restoration.
  3. If such repairs are not previously indicated on the Drawings or elsewhere in the contract documents, then the work will constitute extra work when approved by the Owner's Representative.
- D. Manholes
1. Protect manholes to withstand forces generated by equipment, water, or air pressure used during the liner installation process.
  2. The CONTRACTOR may excavate and remove the cones and risers of manholes if required to accommodate the insertion process.
  3. The reinstallation of the cone, risers, and manhole lid and the surface restoration shall be accomplished in accordance with the requirements of the Owner's Representative and the contract documents.
- E. End Seals

1. Pressure applications (STA 51+04 +/-): Internal mechanical end seals shall be Weko-Seal or approved equal.
2. Gravity application (STA 43+53 +/-): Install a continuous or properly trimmed end seal between the end of the new liner and the host pipe connection. Install end seals in a fully circumferential segment of pipe 3-inches from a structure penetration. Install end seals composed of hydrophilic waterstop bands that are 0.79 inches (20 mm) wide and 0.20 inches (5 mm) high, with a double bump on one side and flat on the other side. Butt the trimmed end seal edges against each other at the crown of the pipe using a 45-degree miter cut. Seals, with any gap between the ends, will not be accepted.

### 3.02 INSTALLATION

#### A. Resin Impregnation

1. The uncured resin in the original containers and the unimpregnated tube shall be impregnated by vacuum or other means, in a factory setting, prior to delivery and installation. The materials and "wet-out" procedure shall be subject to inspection by the ENGINEER. A resin and catalyst system that is compatible with the requirements of the method shall be used.
2. The impregnated liner bag shall be transported to and stored at the site in such a manner that it will not be damaged, exposed to direct sunlight, or result in any public safety hazard. The impregnated liner bag shall be kept cool during shipment and storage. All materials shall be subject to inspection and review by the Owner's Representative prior to installation.

#### B. Liner Installation – Inversion Method

1. The impregnated tube shall be inserted through an existing manhole or other access approved by the Owner's Representative by means of the installation process.
2. The application of hydrostatic head or air pressure shall fully extend the liner to the next designated manhole or termination point and inflate firmly to the pipe wall.
3. The liner shall be installed at a rate not greater than 10 feet per minute at all times.

#### C. Liner Installation – Pull-in Method

1. The impregnated tube shall be inserted through an existing manhole or other access approved by the Owner's Representative by means of the installation process.
2. The tube shall be pulled into place using a power winch with dynamometer or load cell provided on the winch or cable to monitor the pulling forces. The liner shall be installed without exceeding the recommended pulling force. Care should be exercised not to damage the tube as a result of friction during pull-in.
3. The application of hydrostatic head or air pressure shall fully extend the liner to the next designated manhole or termination point and inflate and



firmly adhere the liner to the pipe wall.

D. Curing

1. Provide a UV light train that meets the following requirements:
  - a. minimum of one camera for UV-CCTV inspection of the liner,
  - b. size of the light train is appropriate for the pipe diameter,
  - c. UV bulbs are in proper proximity to the liner wall all around the pipe circumference,
  - d. sensors to record the cure progress,
  - e. logged hours of individual UV Lights incorporated in the light train is less than 80% of the manufacturer's stated usage rate.
2. Maintain light train usage log on-site and submit to ENGINEER upon request.
3. Operate ultraviolet curing lamps at a sufficient output and in a sufficient frequency range to ensure curing of the resin.
4. Optimize multi-lamp ultraviolet curing lights and resin photo-initiator system for curing of the provided resin.
5. Assemble the UV light train according to the manufacturer's recommendations for the sewer pipe and liner diameter. Cure the liner according to the curing protocol, as approved. Maintain light train speed per the manufacturer's requirements, and to assure exothermic reaction has completed. Do not pull the UV light train in a downhill direction during the curing process unless otherwise approved. Approval will not be given where pipe slopes are greater than or equal to 3.0%.
6. Collect curing data and UV-CCTV inspection records during the installation and curing process. Submit copies to the County for review. Where the curing data and the curing protocol differ, the County reserves the right to require additional sampling and testing at no additional cost.

### 3.03 TESTING

A. Material Testing

1. All material testing shall be performed by a registered, independent, third-party laboratory.
2. The CONTRACTOR shall provide certified test results of the short-term properties of the cured lining material from the actual installed liner at a minimum of one location per each liner insertion setup.
3. The cured liner shall be sampled and tested for flexural strength and flexural modulus (short-term) in accordance with the requirements of ASTM D790.
  - a. Liner shall be in compliance with the physical properties stated under Table 33 05 23.32-A of this specification.
  - b. A certificate of compliance shall be provided for long-term flexural modulus.

4. The cured liner samples shall be tested for measurement of thickness in accordance with the requirements of ASTM D2122.
- B. Field Testing
1. After completion of all liner insertion, service reconnections, and finish work at the manholes, the sewer shall be videoed with a color CCTV tilt-head camera recorded in a digital format. The original tape and any associated reporting shall be provided to the Owner's Representative. See Section 33 30 10.16, TV Inspection of Sewer Pipelines, for more specific requirements.

**3.04 SECTIONAL (SHORT) REPAIRS**

- A. Sectional (short) repairs shall be performed in accordance with ASTM F2599 and all the other requirements of this section.

**3.05 ACCEPTANCE**

- A. Acceptance of the UV CIPP shall be based on the Engineer's evaluation of the resin impregnation quality control reports, curing logs, post-construction inspection video, and laboratory test results for the installed pipe samples, which shall demonstrate:
1. Compliance with the required UV CIPP physical properties and thickness.
  2. Observed groundwater infiltration of the liner is zero.
  3. All active service connections are open and clear.
  4. There is no evidence of excessive wrinkles, splits, cracks, breaks, lifts, kinks, scalds, blisters, delaminations, crazing or other defects in the liner.
- B. If any defective liner is discovered after it has been installed, it shall be removed and replaced with either a sound liner or a new pipe. The Contractor shall be responsible for costs of additional testing required to confirm compliance with these requirements. Obtain approval of the Engineer for method of repair, which may require field or workshop demonstration.

**END OF SECTION**

**SECTION 33 11 50  
EXISTING PIPE ABANDONMENT**

**PART 1 : GENERAL**

**1.01 SUMMARY**

- A. This Section includes the removal of existing buried piping and abandonment in place of existing buried piping.
- B. Section includes:
  - 1. Pipe removal.
  - 2. In-place abandonment of pipe.

**1.02 RELATED SECTIONS**

- A. Section 03 60 00, Grouting.
- B. Section 31 23 19, Dewatering.
- C. Section 31 23 24, Flowable Fill.
- D. Section 31 23 33, Trenching, Backfilling and Compacting for Utilities.

**1.03 SUBMITTALS**

- A. In accordance with the provisions of Section 1-06 – Control of Materials submit the following:
  - 1. Piping Abandonment Plan:
    - a. Identify locations specified for pipe abandonment.
    - b. Provide method to be utilized to abandon the pipe, including whether the pipe will be left in place or removed in its entirety.
  - 2. Non-Shrink Grout: Product data in accordance with Section 03 60 00, Grouting.
  - 3. Controlled low-strength material (CLSM): Mix designs in accordance with Submittal requirements of Section 31 23 24, Flowable Fill.

**1.04 REQUIREMENTS OF REGULATORY AGENCIES**

- A. Permits: The Contractor is responsible for obtaining all necessary permits required for completion of the work described herein.

- B. Protection of Persons and Property: Meet all federal, state, and local safety requirements for the protection of workmen, other persons, and property in the vicinity of the work and requirements of the General Provisions.
- C. Protection of Existing Work
- D. Carefully examine the Contract Documents to determine the extent of the work of this Section.
- E. Carefully coordinate the work of this Section with all other work and construction.
- F. Take all necessary precautions to prevent damage to existing facilities or utilities which are to remain in place and be responsible for any damages to existing facilities or utilities, which are caused by the operations.

**1.05 REPAIR OF DAMAGE**

- A. Work procedures shall provide for safe conduct of the work; careful removal and disposition of materials and equipment; protection of facilities, utilities and property which are to remain undisturbed; coordination with existing facilities and utilities to remain in service.
- B. Any damage to existing facilities or utilities to remain as caused by the Contractor's operations shall be repaired to acceptance of Engineer.
- C. Damaged items shall be repaired or replaced with new materials as required to restore damaged items or surfaces to a condition equal to and matching that existing prior to damage or start of work of this contract.

**1.06 EXISTING CONDITIONS**

- A. If the pipe material contains any hazardous materials, such as asbestos, requiring special handling upon removal, it is the responsibility of the Contractor to remove and dispose of the material in accordance with all applicable federal, state, and local regulations.

**PART 2 : PRODUCTS**

**2.01 OWNERSHIP OF EXISTING MATERIALS**

- A. All materials, equipment, miscellaneous items and debris involved, occurring or resulting from pipe removal work shall become the property of the Contractor at the place of origin, unless otherwise specified in the Drawings or by the Engineer.

**2.02 CONTROLLED LOW STRENGTH MATERIAL**

- A. As specified in Section 31 23 24, Flowable Fill.

**PART 3 : EXECUTION****3.01 PIPE REMOVAL**

- A. Where identified on the Drawings, remove, and dispose of all pipe material and associated appurtenances.
  - 1. All air release valves, individual pump station service lines and appurtenances being abandoned shall be removed to 36 inches below finished grade.
- B. All exposed ends of pipes and fittings shall be capped or plugged with an appropriate ductile iron blind flange, cap or plug and restrained.
- C. All excavation and backfilling associated with pipe removal shall be performed in accordance with 31 23 33 Trenching, Backfilling, and Compacting for Utilities.

**3.02 IN-PLACE ABANDONMENT OF PIPING**

- A. Where identified on the Drawings, abandon pipe in place.
- B. All exposed ends of pipes being abandoned in place shall be cut and plugged with a minimum of 2 feet of non-shrink grout.
- C. Prior to placing grout, roughen interior pipe surface and apply epoxy bonding agent.

**3.03 FILLING PIPE WITH CLSM**

- A. All pipe to be abandoned-in-place shall be filled with CLSM.
- B. CLSM shall be placed in a manner to ensure complete filling of the pipe, leaving no cavities or voids.
- C. Install hot taps, saddles, fill lines, and appurtenances as necessary for pumping CLSM from the surface into the pipe being filled.
- D. CLSM shall be pumped up grade from fill lines rigidly connected to the pipes being filled.
- E. Placement of CLSM by free flowing (non-pumped) methods will not be acceptable.
- F. Fill lines shall be located at elevations lower than the pipe being filled.
- G. As the CLSM is being placed, use other fill lines as view ports to ensure complete filling of the pipes.
- H. Relocate pumping equipment as necessary to complete filling of the pipes.
- I. Excavate and cut access holes in the pipes as necessary to complete filling operations.

- J. Perform pipe filling operations in a manner to eliminate all air pockets.
- K. Submit volume calculations for CLSM placed in each filled segment of piping to verify that pipelines have been completely filled.

**3.04 CLEANUP**

- A. During and upon completion of work of this Section, promptly remove all unused tools and equipment, surplus materials, and debris.
- B. Adjacent areas shall be returned to their existing condition prior to the start of work.

**END OF SECTION**

**SECTION 33 30 10.16**  
**TV INSPECTION OF SEWER PIPELINES**

**PART 1 : GENERAL**

**1.01 SUMMARY**

- A. Section Includes:
  - 1. Pipeline flushing and cleaning.
  - 2. TV inspection of sewer pipelines.
  - 3. Audio-video recording of pipeline interior.
- B. Related Requirements:

N/A

**1.02 UNIT PRICE - MEASUREMENT AND PAYMENT**

N/A

**1.03 COORDINATION**

- A. Coordinate Work of this Section with Kitsap County.

**1.04 PREINSTALLATION MEETINGS**

- A. Convene minimum one week prior to commencing Work of this Section.

**1.05 SCHEDULING**

N/A

**1.06 SEQUENCING**

N/A

**1.07 SUBMITTALS**

- A. Submit completed narrated DVDs identified by Project name, street name, right-of-way property name, and manhole numbers.
- B. DVDs become property of Kitsap County.
- C. Inspection Logs:
  - 1. Submit cleaning and TV inspection logs for each section of sewer line to be rehabilitated and three copies of color DVDs for Work performed.
  - 2. Include following minimum information:
    - a. Stationing and location of lateral services, wyes, or tees.
    - b. Clock time references.
    - c. Pipe joints.

- d. Infiltration/inflow defects.
  - e. Cracks.
  - f. Leaks.
  - g. Offset joints.
  - h. Other information required to assess condition of sewer.
- D. Submit specific detailed description of proposed bypass pumping system, including written description of plan addressing quantity, capacity, and location of pumping equipment.
- E. Submit spill plan to address any spills that might occur.
- F. Qualifications Statement:
- 1. Submit qualifications for applicator.

**1.08 QUALITY ASSURANCE**

- A. Perform Work according to “State of Washington Department of Transportation (WSDOT)” and the “Municipality of Kitsap County Department of Public Works” standards.

**1.09 QUALIFICATIONS**

- A. Applicator: Company specializing in performing Work of this Section with minimum 5 years of experience.

**PART 2 : PRODUCTS**

**2.01 DVDS**

- A. Description: Digital video formatted discs.
- B. Audio track containing simultaneously recorded narrative commentary and evaluations of videographer, describing in detail condition of pipeline interior.

**PART 3 : EXECUTION**

**3.01 EXAMINATION**

- A. Verify location of sewer pipelines to be inspected.

**3.02 PREPARATION**

- A. Flush and clean pipeline to remove sludge, dirt, sand, stone, grease, and other materials to ensure clear view of interior conditions.
- B. Intercept flushed debris at next downstream manhole using weir or screening device; remove and dispose of debris off Site.
- C. Furnish temporary bypass pumping system around Work area for time required to complete TV inspection.



**3.03 APPLICATION**

- A. Closed-Circuit TV Camera System:
  - 1. Use cameras specifically designed and constructed for closed-circuit sewer line inspection. Use camera equipment with pan and tilt capability to view each lateral connection at multiple angles.
  - 2. Use camera capable of moving both upstream and downstream with minimum 1,000 feet (300 m) horizontal distance within one setup and direct-reading cable position meter.

**3.04 FIELD QUALITY CONTROL**

- A. Pipeline Inspection:
  - 1. Audio-video record sections of sewer pipeline between designated manholes.
  - 2. Identify and record locations of flat grades, dips, deflected joints, open joints, broken pipe, protrusions into pipeline, and points of infiltration.
  - 3. Locate and record service connections.
  - 4. Record locations of pipeline defects, connection horizontal distance in feet (meters), and direction from manholes.
  - 5. Video record with pipe section plugged to view 100 percent of inside pipe diameter; use flow-control methods as specified for bypass pumping system to eliminate surcharging and reduce flow.

**END OF SECTION**

THIS PAGE INTENTIONALLY LEFT BLANK

**SECTION 40 05 23.72  
MISCELLANEOUS VALVES**

**PART 1 : GENERAL**

**1.01 SUMMARY**

- A. This Section includes miscellaneous valves not included in other Sections for use in buried service and utility vaults.
- B. Section Includes:
  - 1. Combination air/vacuum valves.
  - 2. Blow-off assemblies.

**1.02 RELATED SECTION**

- A. Section 09 90 00, Painting and Coating

**1.03 REFERENCE STANDARDS**

- A. American Society of Mechanical Engineers (ASME):
  - 1. ASME B16.1 - Gray Iron Pipe Flanges and Flanged Fittings.
  - 2. ASME B16.5 - Pipe Flanges and Flanged Fittings: NPS 1/2 through 24 - Metric/Inch Standard.
  - 3. ASME B16.11 - Forged Fittings, Socket-Welding and Threaded.
  - 4. ASME B16.42 - Ductile Iron Pipe Flanges and Flanged Fittings: Classes 150 and 300.
  - 5. ASME B1.20.1 - Pipe Threads, General Purpose (Inch).
- B. ASTM International (ASTM):
  - 1. ASTM A126 - Standard Specification for Gray Iron Castings for Valves, Flanges, and Pipe Fittings.
  - 2. ASTM A536 - Standard Specification for Ductile Iron Castings.
  - 3. ASTM B62 - Standard Specification for Composition Bronze or Ounce Metal Castings.

**1.04 COORDINATION**

- A. Contractor shall be solely responsible to coordinate Work of this Section with piping, equipment, and appurtenances.

**1.05 SUBMITTALS**

- A. Submittal documents shall conform to the requirements of Section 1-06 – Control of Materials.

- B. Product Data:
  - 1. Submit manufacturer's latest published literature. Include illustrations, installation and maintenance instructions, and parts lists.
  - 2. Submit valve cavitation limits.
- C. Manufacturer's Certificate: Certify that products meet or exceed specified requirements.
- D. Manufacturer Instructions: Submit installation instructions and special requirements, including storage and handling procedures.
- E. Lining and coating data.
- F. Valve Labeling Schedule: Indicate valve locations and nametag text.
- G. Certification of Valves Larger than 12 inches: Furnish certified copies of hydrostatic factory tests, indicating compliance with applicable standards.
- H. Source Quality-Control Submittals: Indicate results of factory tests and inspections.
- I. Field Quality-Control Submittals: Indicate results of Contractor-furnished tests and inspections, including factory-applied coatings.

**1.06 CLOSEOUT SUBMITTALS**

- A. Project Record Documents: Record actual locations of valves and actuators.
- B. Operation and Maintenance Data: Submit information for valves.

**1.07 MAINTENANCE MATERIAL SUBMITTALS**

- A. Spare Parts:
  - 1. Furnish one set of manufacturer's recommended spare parts.
- B. Tools:
  - 1. Furnish special wrenches and other devices required for Owner to maintain equipment.
  - 2. Furnish compatible and appropriately labeled toolbox when requested by Owner.

**1.08 QUALITY ASSURANCE**

- A. Cast manufacturer's name, pressure rating, size of valve, and year of fabrication into valve body.
- B. Valve Testing: Each valve body shall be tested under a test pressure equal to twice its design water-working pressure.

- C. Certification: Prior to shipment, submit for all valves over 12 inches in diameter, certified, notarized copies of the hydrostatic factory tests, showing compliance with the applicable standards of AWWA, ANSI, ASTM, etc. Valves tested and supplied shall be trackable and traceable by serial number, tagged or otherwise noted on valve, upon arrival to Site.
- D. Maintain clearances as indicated on Drawings.
- E. Unless otherwise noted, all water works materials provided for the Project shall be new, of first-class quality and shall be made by reputable manufacturers.
- F. All material of a like kind shall be provided from a single manufacturer, unless otherwise approved by the Engineer.

### 1.09 DELIVERY, STORAGE, AND HANDLING

- A. Inspection: Accept materials on Site in manufacturer's original packaging and inspect for damage.
- B. Store materials according to manufacturer instructions.
  - 1. Store materials in areas protected from weather, moisture, or other potential damage.
  - 2. Do not store materials directly on ground.
  - 3. Protection:
  - 4. Protect materials from moisture and dust by storing in clean, dry location remote from construction operations areas.
  - 5. Protect valve ends from entry of foreign materials by providing temporary covers and plugs.
  - 6. Provide additional protection according to manufacturer instructions.
- C. Handle products carefully to prevent damage to interior or exterior surfaces.
- D. All defective or damaged materials shall be replaced with new materials at no cost to the Owner.

## PART 2 : PRODUCTS

### 2.01 COMBINATION AIR/VACUUM VALVES

- A. Description:
  - 1. Construction: Two independent valves: one air/vacuum valve, one air release valve.
  - 2. Inlet Size: Greater than 2-inch diameter.
  - 3. Cast iron body and cover. Comply with ASTM A126, Class B.
  - 4. Stainless steel orifice and float. Comply with ASTM A240.
  - 5. Valves seats: Buna-N.

- 6. Provide HDPE ¼-turn ball valves on air/vacuum valves.
- B. Manufacturers:
  - 1. ARI – Flow Accessories, no substitutions.

**2.02 BALL VALVES, 2 INCHES AND UNDER**

- A. Description:
  - 1. Four hundred-pound. Water, oil, and gas rating (WOG) with bronze body and trim, unless otherwise shown on the Drawings.
  - 2. Seat ring: Tetrafluoroethylene (TFE).
  - 3. O-ring seals: Fluorocarbon.
  - 4. Three-piece construction so that maintenance can be performed without distributing the valve body after installation.
- B. Manufacturer:
  - 1. Nibco T-590-Y or equal.

**2.03 SOURCE QUALITY CONTROL**

- A. Testing Pressure-Reducing and Pressure-Sustaining Valves:
  - 1. Leakage Testing:
    - a. Test each assembled valve hydrostatically at 1-1/2 times rated working pressure for minimum five minutes.
    - b. Test each valve for leakage at rated working pressure against closed valve.
    - c. Permitted Leakage: None.
  - 2. Functional Testing:
    - a. Test each valve to verify specified performance.

**PART 3 : EXECUTION**

**3.01 INSTALLATION**

- A. Install valves per manufacturer requirements and recommendations.
- B. Install all valves with valve seats level.
- C. Install protective strainers upstream of solenoid valves, pressure-reducing valves, and pressure-sustaining valves.

**END OF SECTION**

## **SECTION 40 05 61 GATE VALVES**

### **PART 1 : GENERAL**

#### **1.01 SUMMARY**

- A. This Section includes gate valves for use in buried service and utility vaults.
- B. Section Includes:
  - 1. Resilient-seated gate valves.
  - 2. General duty gate valves smaller than 3 inches.

#### **1.02 REFERENCE STANDARDS**

- A. American Society of Mechanical Engineers (ASME):
  - 1. ASME B16.1 - Gray Iron Pipe Flanges and Flanged Fittings.
  - 2. ASME B16.5 - Pipe Flanges and Flanged Fittings: NPS 1/2 through 24 - Metric/Inch Standard.
  - 3. ASME B16.42 - Ductile Iron Pipe Flanges and Flanged Fittings: Classes 150 and 300.
  - 4. ASME B1.20.1 - Pipe Threads, General Purpose (Inch).
- B. ASTM International (ASTM):
  - 1. ASTM A126 - Standard Specification for Gray Iron Castings for Valves, Flanges, and Pipe Fittings.
  - 2. ASTM B62 - Standard Specification for Composition Bronze or Ounce Metal Castings.
  - 3. ASTM B584 - Standard Specification for Copper Alloy Sand Castings for General Applications.
- C. American Water Works Association (AWWA):
  - 1. AWWA C500 - Metal-Seated Gate Valves for Water Supply Service.
  - 2. AWWA C509 - Resilient-Seated Gate Valves for Water Supply Service.
  - 3. AWWA C550 - Protecting Interior Coatings for Valves and Hydrants.
- D. Manufacturers Standardization Society of the Valve and Fittings Industry (MSS):
  - 1. MSS SP-70 - Gray Iron Gate Valves, Flanged and Threaded Ends.
  - 2. MSS SP-80 - Bronze Gate, Globe, Angle and Check Valves.

#### **1.03 SUBMITTALS**

- A. Submittal documents shall conform to the requirements of Section 1-06 – Control of Materials.

**PART 2 : PRODUCTS****2.01 RESILIENT-SEATED GATE VALVES**

- A. Description:
1. Comply with AWWA C509.
  2. Minimum Pressure Rating:
    - a. Twelve-inch Diameter and Smaller: 200 pounds per square inch (gauge) (psig).
    - b. Sixteen-inch Diameter and Larger: 150 psig.
  3. End Connections: As shown in the Drawings.
    - a. Standard mechanical joint ends comply with ANSI/AWWA C111.
    - b. Flanged end dimensions and drilling comply with ANSI/ASME B16.1, class 125. Comply with AWWA C115 & ASME 16.5.
      - 1) The Contractor shall coordinate with pipe, valve, and fitting suppliers to make certain pipe, valve, and fitting flanges match in bolt pattern.
  4. Gear Actuators: Conforming to AWWA C509 for manual valves.
  5. Linings and Coatings:
    - a. Corrosion-resistant fusion bonded epoxy conforming to AWWA C550 and NSF 61.
    - b. All internal and external ferrous surfaces.
    - c. Do not coat flange faces of valves.
  6. Bi-directional flow.
- B. Operation:
1. Non-rising stem.
  2. Open counterclockwise when viewing the valve from above, unless otherwise indicated in the Drawings.
  3. Buried Valves: All buried valves shall be provided with 2-inch square operating nuts.
- C. Materials:
1. Wedge:
    - a. ASTM A126, cast iron or ASTM A536, ductile iron.
    - b. Fully encapsulated with molded rubber.
  2. Body and Bonnet:
    - a. ASTM A126, cast iron or ASTM A536, ductile iron.
  3. Stem, Stem Nuts, Glands, and Bushings: ASTM B584, bronze.
  4. Valve Body Bolting: Stainless steel.



- D. Manufacturers:
  - 1. Clow Valve Company.
  - 2. M&H Valve.
  - 3. U.S. Pipe.
  - 4. American Flow Control.
  - 5. Mueller Company.

**2.02 GENERAL-DUTY GATE VALVES - SMALLER THAN 3 INCHES**

- A. Two inches and Smaller:
  - 1. MSS SP 80, Class 125.
  - 2. Body and Trim: ASTM B584, bronze.
  - 3. Bonnet: Union.
  - 4. Operation: Handwheel.
  - 5. Inside screw [with back-seating stem].
  - 6. Wedge Disc: Solid; ASTM B584, bronze.
  - 7. End Connections: Threaded.
- B. Two and one-half inches to 3 inches:
  - 1. MSS SP 70, Class 125.
  - 2. Stem: Non-rising.
  - 3. Body: ASTM A126, cast iron.
  - 4. Trim: Bronze.
  - 5. Bonnet: Bolted bonnet.
  - 6. Handwheel, outside screw and yoke.
  - 7. Wedge Disc: Solid, with bronze seat rings.
  - 8. End Connections: ASME B16.1, ASME B16.5, ASME B16.42, flanged.

**2.03 SOURCE QUALITY CONTROL**

- A. Testing: Test gate valves according to AWWA C509.

**PART 3 : EXECUTION****3.01 INSTALLATION**

- A. Install according to manufacturer's instructions.

- B. Support valves in plastic piping to prevent undue stresses on piping.

**END OF SECTION**

**SECTION 40 94 23**  
**FLOW PROCESS MEASUREMENT DEVICES**

**PART 1 : GENERAL**

**1.01 SUMMARY**

- A. This Section includes flow rate measurement devices, including sensors, indicators, transmitters, recorders, and integrators. Flow meter types that are covered in this Section are magnetic.
- B. Section Includes:
  - 1. Magnetic flow meters
  - 2. Transmitters
  - 3. Indicators

**1.02 REFERENCE STANDARDS**

- A. American Society of Mechanical Engineers (ASME):
  - 1. ASME B16.1 - Gray Iron Pipe Flanges and Flanged Fittings.
- B. ASTM International (ASTM):
  - 1. ASTM A126 - Standard Specification for Gray Iron Castings for Valves, Flanges, and Pipe Fittings.
  - 2. ASTM B61 - Standard Specification for Steam or Valve Bronze Castings.
- C. American Water Works Association (AWWA):
  - 1. AWWA C200 - Steel Water Pipe 6 Inch (150 mm) and Larger
  - 2. AWWA C207 - Steel Pipe Flanges for Waterworks Service - Sizes 4-inch Through 144-inch.
  - 3. AWWA C704 - Propeller-Type Meters for Waterworks Applications.
  - 4. AWWA Manual M6 - Water Meters-Selection, Installation, Testing, And Maintenance.
- D. National Electrical Manufacturers Association (NEMA):
  - 1. NEMA 250 - Enclosures for Electrical Equipment (1000 Volts Maximum).

**1.03 COORDINATION**

- A. Coordinate Work of this Section with Pump Station 17 and 24 improvements.

**1.04 SUBMITTALS**

- A. Submittal documents shall conform to the requirements of Section 1-06 – Control of Materials.

- B. Product Data: Submit manufacturer's Product Data for system materials and component equipment, including connection requirements.
- C. Shop Drawings:
  - 1. Indicate system materials and component equipment.
  - 2. Wiring diagrams and electrical data.
  - 3. Submit installation requirements and other details.
- D. Manufacturer's Certificate: Certify that products meet or exceed specified requirements.
- E. Manual: Complete operation and maintenance instructions for metering systems, including relevant instrumentation and controls.
- F. Source Quality-Control Submittals: Indicate results of factory tests and inspections.
- G. Field Quality-Control Submittals: Indicate results of Contractor-furnished tests and inspections.
- H. Manufacturer Reports:
  - 1. Certify that equipment has been installed according to manufacturer's instructions.
  - 2. Indicate activities on Site, adverse findings, and recommendations.

**1.05 CLOSEOUT SUBMITTALS**

- A. Project Record Documents: Record actual locations and final orientation of equipment and accessories.

**1.06 MAINTENANCE MATERIAL SUBMITTALS**

- A. Spare Parts:
  - 1. Furnish one set of manufacturer's recommended spare parts.
- B. Tools: Furnish special wrenches and/or other specialty devices required for Owner to maintain devices.

**1.07 QUALITY ASSURANCE**

- A. Ensure materials of construction of wetted parts are compatible with process liquid.

**1.08 DELIVERY, STORAGE, AND HANDLING**

- A. Inspection: Accept equipment on Site in manufacturer's original packaging and inspect for damage.
- B. Store equipment according to manufacturer's instructions.

- C. Protection:
  - 1. Protect materials from moisture and dust by storing in clean, dry location remote from areas involved in construction operations.
  - 2. Provide additional protection according to manufacturer's instructions.

### 1.09 CLEANUP

- A. Prior to final acceptance, remove all debris from the site. Clean all meters, controls, cabinets, and other metering appurtenances.

### 1.10 WARRANTY

- A. Furnish two-year manufacturer's warranty for flow measurement devices.

## PART 2 : PRODUCTS

### 2.01 DESCRIPTION

- A. Furnish all materials, including unit conversions and algorithms, as required, for application as specified herein.

### 2.02 MAGNETIC FLOW METERS

- A. Provide a magnetic flowmeter for each location shown on the Drawings and / or listed below:
  - 1. Magmeter shall be Krohne Enviromag 2000 or Siemens SITRANS F M MAG 5100W (with associated transmitter Sitrans FM 5000), no substitutions.
- B. SPECIFICATIONS:
  - 1. The flow tube shall be a NEMA 4X enclosure rated for accidental submergence in water up to 30 feet for 48 hours.
  - 2. Flowtube shall be rated for class 1 div 2 group C & D.
  - 3. Ground rings.
  - 4. Bi-directional flow capable.
  - 5. Accuracy of +/- 1 percent for flow velocity between 3 & 31 fps.
  - 6. Magnetic flowmeter shall be hydraulically calibrated at the manufacturer's facility against a master meter traceable to the NBS. A printout of the calibration data and calibration curve shall be furnished with each magnetic flowmeter.
  - 7. Power input 24 VAC, output 4-20mA.
  - 8. Dry contact closure for every X gallons of flow [where X = max flow of meter (gpm) / 10] – for accurate flow reading into the PLC. Contact shall remain closed for a minimum of 3 seconds.

- C. FEATURES:
  - 1. Flange material: 316L stainless steel
  - 2. Liner: Teflon or EPDM
  - 3. Electrodes: 316 stainless steel
  - 4. Integral transmitter with digital indicator (readout in GPM)
- D. MOUNTING: The transmitter, transducer, and sensor assembly shall be mounted to the pipe per the requirements of the Drawings and the manufacturer.
- E. Substitutions: Not accepted.

### **PART 3 : EXECUTION**

#### **3.01 EXAMINATION**

- A. Verify that items provided by other Sections of Work are ready to receive Work of this Section.

#### **3.02 INSTALLATION**

- A. Coordinate location and orientation of flow meter with final equipment installations.
- B. Ensure that instruments are located to be easily accessible for maintenance.

#### **3.03 FIELD QUALITY CONTROL**

- A. Testing:
  - 1. Test and calibrate flow meter to demonstrate that it meets specified accuracy requirements.
  - 2. Comply with AWWA Manual M6.
- B. Manufacturer Services: Furnish services of manufacturer's representative experienced in installation of products furnished under this Section for not less than one day on Site for installation, inspection, field testing, and instructing Owner's personnel in maintenance of equipment.
- C. Equipment Acceptance:
  - 1. Adjust, repair, modify, or replace components failing to perform as specified, and rerun tests.
  - 2. Make final adjustments to equipment under direction of manufacturer's representative.
- D. Furnish installation certificate from equipment manufacturer's representative attesting that equipment has been properly installed and is ready for startup and testing.

**3.04 DEMONSTRATION**

- A. Demonstrate equipment startup, shutdown, routine maintenance, and emergency repair procedures to Owner's personnel.

**END OF SECTION**

THIS PAGE INTENTIONALLY LEFT BLANK



**SECTION 40 94 24  
PRESSURE SENSOR RINGS**

**PART 1 : GENERAL**

**1.01 SUMMARY**

- A. Section includes:
  - 1. Scope
  - 2. Reference Standards
  - 3. Quality Assurance.
  - 4. Submittals.
  - 5. Products Requirements.
  - 6. Installation.
  - 7. Manufacturer's Services.

**1.02 SCOPE**

- A. This Section specifies requirements for supply and installation of Pressure and measuring system(s). This includes testing, documenting, and start up.
- B. CONTRACTOR shall provide all components, piping, wiring, accessories and labor required for a complete, workable and integrated system.
- C. Instruments shall be mounted as shown on the plans.

**1.03 REFERENCE STANDARDS**

- A. ASTM – American Society for Testing and Materials
- B. ANSI B16.1 - Gray Iron Pipe Flanges and Flanged Fittings
- C. MSS SP67 – Butterfly Valves

**1.04 1.4 QUALITY ASSURANCE**

- A. Supplier shall have at least ten (10) years' experience in the manufacture of pressure sensor rings utilizing an elastomer sensing element and shall provide references and a list of installations upon request.

**1.05 SUBMITTALS**

- A. Submittals requirements specified in: Section 01-06 Control of Materials.
- B. Product Data: For each type of device and system:
  - 1. Include product data sheets and equipment brochures showing standard products and specified accessories.
    - a. Mark data sheets to clearly show exact product and options being provided.

2. Submit product literature that includes information on the performance and operation of the sensor, materials of construction, dimensions and weights, elastomer characteristics, and pressure ratings.
- C. Manufacturer's installation instructions, including mounting requirements.
- D. Operation and maintenance information.
- E. Warranty information.

## PART 2 : PRODUCTS

### 2.01 MANUFACTURERS

**All sensors shall be of the series 40 as manufactured by the Red Valve Co., Inc. of Carnegie, PA 15106 or approved equal.**

### 2.02 GENERAL

- A. Pressure Sensors are to be of the full flange design, to be retained between standard ANSI B16.1 Class 125/6.5 Class 150 pipeline flanges. Flange bolts shall pass through sensor body and flanges. The outside diameter of the sensor shall match the outside diameter of the mating flange. Mating flanges shall be ANSI B16.5 Class 150, Type 316 stainless Steel. Lining of the sleeve shall be suitable for sewer applications. Face-to-face of the entire sensor shall be no longer than specifications MSS-SP67.
- B. Sensor shall be flow through design with flexible elastomer sensing ring around the full circumference. The elastomer sensing ring shall be rigidly clamped between metal end cover flanges, and no part of the elastomeric sensing ring shall be exposed to the external face of the sensor. There shall be no dead ends or crevices and flow passage shall make the sensor self-cleaning.
- C. The pressure sensing ring shall measure pressure for 360° around the full inside circumference of the pipeline. Flexible sensing ring shall have a cavity behind the ring filled with fluid to transfer pressure to the gauge. Sensor shall be manufactured in the USA.

### 2.03 FUNCTION

- A. Line pressure pushes against an elastomer ring inside the sensor. The deflection of the ring displaces a fluid fill inside the body of the sensor, forcing the fluid into a pressure-measuring device.

### 2.04 ELECTRICAL REQUIREMENTS

- A. Input current: 20 mA max (loop Power)
- B. Signal Output: 4-20mA, 0-5 VDC, 0-2.5VDC Analog signal. Signal shall change in direct linear proportional to changes in measured value.
- C. Insulation resistance: 100 Mega  $\Omega$  @ 500 VDC Capable of withstanding a 600 Volt spike in accordance with ENV 50142 without damage.

**PART 3 : EXECUTION**

**3.01 INSTALLATION**

- A. Sensor shall be installed in accordance with manufacturer's written Installation and Operation Manual and approved submittals.
- B. Contractor shall install pressure sensor ring transmitter and wire transmitter to existing facilities as directed by Owner.

**3.02 MANUFACTURER'S SERVICES**

- A. Manufacturer's authorized representative shall be available for customer service during installation and start-up, and to train personnel in the operation, maintenance and troubleshooting of the sensor.
- B. Manufacturer shall also make customer service available directly from the factory in addition to authorized representatives for assistance during installation and start-up, and to train personnel in the operation, maintenance and troubleshooting of the sensor.

**END OF SECTION**

THIS PAGE INTENTIONALLY LEFT BLANK



**APPENDIX A  
PREVAILING WAGE RATES**

---

BACK OF COVER  
THIS PAGE INTENTIONALLY LEFT BLANK

State of Washington  
 Department of Labor & Industries  
 Prevailing Wage Section - Telephone 360-902-5335  
 PO Box 44540, Olympia, WA 98504-4540

**Washington State Prevailing Wage**

The PREVAILING WAGES listed here include both the hourly wage rate and the hourly rate of fringe benefits. On public works projects, worker's wage and benefit rates must add to not less than this total. A brief description of overtime calculation requirements are provided on the Benefit Code Key.

Journey Level Prevailing Wage Rates for the Effective Date: 2/3/2022

<u>County</u>	<u>Trade</u>	<u>Job Classification</u>	<u>Wage</u>	<u>Holiday</u>	<u>Overtime</u>	<u>Note</u>	<u>*Risk Class</u>
Kitsap	<a href="#">Asbestos Abatement Workers</a>	Journey Level	\$54.62	<u>5D</u>	<u>1H</u>		<a href="#">View</a>
Kitsap	<a href="#">Boilermakers</a>	Journey Level	\$70.79	<u>5N</u>	<u>1C</u>		<a href="#">View</a>
Kitsap	<a href="#">Brick Mason</a>	Journey Level	\$63.32	<u>7E</u>	<u>1N</u>		<a href="#">View</a>
Kitsap	<a href="#">Brick Mason</a>	Pointer-Caulker-Cleaner	\$63.32	<u>7E</u>	<u>1N</u>		<a href="#">View</a>
Kitsap	<a href="#">Building Service Employees</a>	Janitor	\$14.49		<u>1</u>		<a href="#">View</a>
Kitsap	<a href="#">Building Service Employees</a>	Shampooer	\$14.49		<u>1</u>		<a href="#">View</a>
Kitsap	<a href="#">Building Service Employees</a>	Waxer	\$14.49		<u>1</u>		<a href="#">View</a>
Kitsap	<a href="#">Building Service Employees</a>	Window Cleaner	\$14.49		<u>1</u>		<a href="#">View</a>
Kitsap	<a href="#">Cabinet Makers (In Shop)</a>	Journey Level	\$23.72		<u>1</u>		<a href="#">View</a>
Kitsap	<a href="#">Carpenters</a>	Acoustical Worker	\$68.24	<u>7A</u>	<u>4C</u>		<a href="#">View</a>
Kitsap	<a href="#">Carpenters</a>	Bridge, Dock And Wharf Carpenters	\$68.19	<u>7A</u>	<u>4C</u>		<a href="#">View</a>
Kitsap	<a href="#">Carpenters</a>	Carpenter	\$68.19	<u>7A</u>	<u>4C</u>		<a href="#">View</a>
Kitsap	<a href="#">Carpenters</a>	Floor Finisher	\$68.19	<u>7A</u>	<u>4C</u>		<a href="#">View</a>
Kitsap	<a href="#">Carpenters</a>	Floor Layer	\$68.19	<u>7A</u>	<u>4C</u>		<a href="#">View</a>
Kitsap	<a href="#">Carpenters</a>	Scaffold Erector	\$68.19	<u>7A</u>	<u>4C</u>		<a href="#">View</a>
Kitsap	<a href="#">Cement Masons</a>	Application of all Composition Mastic	\$67.41	<u>7A</u>	<u>4U</u>		<a href="#">View</a>
Kitsap	<a href="#">Cement Masons</a>	Application of all Epoxy Material	\$66.91	<u>7A</u>	<u>4U</u>		<a href="#">View</a>
Kitsap	<a href="#">Cement Masons</a>	Application of all Plastic Material	\$67.41	<u>7A</u>	<u>4U</u>		<a href="#">View</a>
Kitsap	<a href="#">Cement Masons</a>	Application of Sealing Compound	\$66.91	<u>7A</u>	<u>4U</u>		<a href="#">View</a>
Kitsap	<a href="#">Cement Masons</a>	Application of Underlayment	\$67.41	<u>7A</u>	<u>4U</u>		<a href="#">View</a>
Kitsap	<a href="#">Cement Masons</a>	Building General	\$66.91	<u>7A</u>	<u>4U</u>		<a href="#">View</a>
Kitsap	<a href="#">Cement Masons</a>	Composition or Kalman Floors	\$67.41	<u>7A</u>	<u>4U</u>		<a href="#">View</a>
Kitsap	<a href="#">Cement Masons</a>	Concrete Paving	\$66.91	<u>7A</u>	<u>4U</u>		<a href="#">View</a>
Kitsap	<a href="#">Cement Masons</a>	Curb & Gutter Machine	\$67.41	<u>7A</u>	<u>4U</u>		<a href="#">View</a>
Kitsap	<a href="#">Cement Masons</a>	Curb & Gutter, Sidewalks	\$66.91	<u>7A</u>	<u>4U</u>		<a href="#">View</a>
Kitsap	<a href="#">Cement Masons</a>	Curing Concrete	\$66.91	<u>7A</u>	<u>4U</u>		<a href="#">View</a>

Kitsap	<a href="#">Cement Masons</a>	Finish Colored Concrete	\$67.41	<a href="#">7A</a>	<a href="#">4U</a>		<a href="#">View</a>
Kitsap	<a href="#">Cement Masons</a>	Floor Grinding	\$67.41	<a href="#">7A</a>	<a href="#">4U</a>		<a href="#">View</a>
Kitsap	<a href="#">Cement Masons</a>	Floor Grinding/Polisher	\$66.91	<a href="#">7A</a>	<a href="#">4U</a>		<a href="#">View</a>
Kitsap	<a href="#">Cement Masons</a>	Green Concrete Saw, self-powered	\$67.41	<a href="#">7A</a>	<a href="#">4U</a>		<a href="#">View</a>
Kitsap	<a href="#">Cement Masons</a>	Grouting of all Plates	\$66.91	<a href="#">7A</a>	<a href="#">4U</a>		<a href="#">View</a>
Kitsap	<a href="#">Cement Masons</a>	Grouting of all Tilt-up Panels	\$66.91	<a href="#">7A</a>	<a href="#">4U</a>		<a href="#">View</a>
Kitsap	<a href="#">Cement Masons</a>	Gunite Nozzleman	\$67.41	<a href="#">7A</a>	<a href="#">4U</a>		<a href="#">View</a>
Kitsap	<a href="#">Cement Masons</a>	Hand Powered Grinder	\$67.41	<a href="#">7A</a>	<a href="#">4U</a>		<a href="#">View</a>
Kitsap	<a href="#">Cement Masons</a>	Journey Level	\$66.91	<a href="#">7A</a>	<a href="#">4U</a>		<a href="#">View</a>
Kitsap	<a href="#">Cement Masons</a>	Patching Concrete	\$66.91	<a href="#">7A</a>	<a href="#">4U</a>		<a href="#">View</a>
Kitsap	<a href="#">Cement Masons</a>	Pneumatic Power Tools	\$67.41	<a href="#">7A</a>	<a href="#">4U</a>		<a href="#">View</a>
Kitsap	<a href="#">Cement Masons</a>	Power Chipping & Brushing	\$67.41	<a href="#">7A</a>	<a href="#">4U</a>		<a href="#">View</a>
Kitsap	<a href="#">Cement Masons</a>	Sand Blasting Architectural Finish	\$67.41	<a href="#">7A</a>	<a href="#">4U</a>		<a href="#">View</a>
Kitsap	<a href="#">Cement Masons</a>	Screed & Rodding Machine	\$67.41	<a href="#">7A</a>	<a href="#">4U</a>		<a href="#">View</a>
Kitsap	<a href="#">Cement Masons</a>	Spackling or Skim Coat Concrete	\$66.91	<a href="#">7A</a>	<a href="#">4U</a>		<a href="#">View</a>
Kitsap	<a href="#">Cement Masons</a>	Troweling Machine Operator	\$67.41	<a href="#">7A</a>	<a href="#">4U</a>		<a href="#">View</a>
Kitsap	<a href="#">Cement Masons</a>	Troweling Machine Operator on Colored Slabs	\$67.41	<a href="#">7A</a>	<a href="#">4U</a>		<a href="#">View</a>
Kitsap	<a href="#">Cement Masons</a>	Tunnel Workers	\$67.41	<a href="#">7A</a>	<a href="#">4U</a>		<a href="#">View</a>
Kitsap	<a href="#">Divers &amp; Tenders</a>	Bell/Vehicle or Submersible Operator (Not Under Pressure)	\$122.49	<a href="#">7A</a>	<a href="#">4C</a>		<a href="#">View</a>
Kitsap	<a href="#">Divers &amp; Tenders</a>	Dive Supervisor/Master	\$86.04	<a href="#">7A</a>	<a href="#">4C</a>		<a href="#">View</a>
Kitsap	<a href="#">Divers &amp; Tenders</a>	Diver	\$122.49	<a href="#">7A</a>	<a href="#">4C</a>	<a href="#">8V</a>	<a href="#">View</a>
Kitsap	<a href="#">Divers &amp; Tenders</a>	Diver On Standby	\$81.04	<a href="#">7A</a>	<a href="#">4C</a>		<a href="#">View</a>
Kitsap	<a href="#">Divers &amp; Tenders</a>	Diver Tender	\$73.60	<a href="#">7A</a>	<a href="#">4C</a>		<a href="#">View</a>
Kitsap	<a href="#">Divers &amp; Tenders</a>	Manifold Operator	\$73.60	<a href="#">7A</a>	<a href="#">4C</a>		<a href="#">View</a>
Kitsap	<a href="#">Divers &amp; Tenders</a>	Manifold Operator Mixed Gas	\$78.60	<a href="#">7A</a>	<a href="#">4C</a>		<a href="#">View</a>
Kitsap	<a href="#">Divers &amp; Tenders</a>	Remote Operated Vehicle Operator/Technician	\$73.60	<a href="#">7A</a>	<a href="#">4C</a>		<a href="#">View</a>
Kitsap	<a href="#">Divers &amp; Tenders</a>	Remote Operated Vehicle Tender	\$68.64	<a href="#">7A</a>	<a href="#">4C</a>		<a href="#">View</a>
Kitsap	<a href="#">Dredge Workers</a>	Assistant Engineer	\$73.62	<a href="#">5D</a>	<a href="#">3F</a>		<a href="#">View</a>
Kitsap	<a href="#">Dredge Workers</a>	Assistant Mate (Deckhand)	\$73.05	<a href="#">5D</a>	<a href="#">3F</a>		<a href="#">View</a>
Kitsap	<a href="#">Dredge Workers</a>	Boatmen	\$73.62	<a href="#">5D</a>	<a href="#">3F</a>		<a href="#">View</a>
Kitsap	<a href="#">Dredge Workers</a>	Engineer Welder	\$75.03	<a href="#">5D</a>	<a href="#">3F</a>		<a href="#">View</a>
Kitsap	<a href="#">Dredge Workers</a>	Leverman, Hydraulic	\$76.53	<a href="#">5D</a>	<a href="#">3F</a>		<a href="#">View</a>
Kitsap	<a href="#">Dredge Workers</a>	Mates	\$73.62	<a href="#">5D</a>	<a href="#">3F</a>		<a href="#">View</a>
Kitsap	<a href="#">Dredge Workers</a>	Oiler	\$73.05	<a href="#">5D</a>	<a href="#">3F</a>		<a href="#">View</a>
Kitsap	<a href="#">Drywall Applicator</a>	Journey Level	\$67.54	<a href="#">5D</a>	<a href="#">1H</a>		<a href="#">View</a>
Kitsap	<a href="#">Drywall Tapers</a>	Journey Level	\$67.91	<a href="#">5P</a>	<a href="#">1E</a>		<a href="#">View</a>
Kitsap	<a href="#">Electrical Fixture Maintenance Workers</a>	Journey Level	\$33.19	<a href="#">5L</a>	<a href="#">1E</a>		<a href="#">View</a>
Kitsap	<a href="#">Electricians - Inside</a>	Cable Splicer	\$94.22	<a href="#">7C</a>	<a href="#">4E</a>		<a href="#">View</a>
Kitsap	<a href="#">Electricians - Inside</a>	Cable Splicer (tunnel)	\$101.27	<a href="#">7C</a>	<a href="#">4E</a>		<a href="#">View</a>
Kitsap	<a href="#">Electricians - Inside</a>	Certified Welder	\$91.00	<a href="#">7C</a>	<a href="#">4E</a>		<a href="#">View</a>



Kitsap	<a href="#">Electricians - Inside</a>	Certified Welder (tunnel)	\$97.74	<u>7C</u>	<u>4E</u>		<a href="#">View</a>
Kitsap	<a href="#">Electricians - Inside</a>	Construction Stock Person	\$44.78	<u>7C</u>	<u>4E</u>		<a href="#">View</a>
Kitsap	<a href="#">Electricians - Inside</a>	Journey Level	\$87.80	<u>7C</u>	<u>4E</u>		<a href="#">View</a>
Kitsap	<a href="#">Electricians - Inside</a>	Journey Level (tunnel)	\$94.22	<u>7C</u>	<u>4E</u>		<a href="#">View</a>
Kitsap	<a href="#">Electricians - Motor Shop</a>	Craftsman	\$15.37		<u>1</u>		<a href="#">View</a>
Kitsap	<a href="#">Electricians - Motor Shop</a>	Journey Level	\$14.69		<u>1</u>		<a href="#">View</a>
Kitsap	<a href="#">Electricians - Powerline Construction</a>	Cable Splicer	\$82.39	<u>5A</u>	<u>4D</u>		<a href="#">View</a>
Kitsap	<a href="#">Electricians - Powerline Construction</a>	Certified Line Welder	\$75.64	<u>5A</u>	<u>4D</u>		<a href="#">View</a>
Kitsap	<a href="#">Electricians - Powerline Construction</a>	Groundperson	\$49.17	<u>5A</u>	<u>4D</u>		<a href="#">View</a>
Kitsap	<a href="#">Electricians - Powerline Construction</a>	Heavy Line Equipment Operator	\$75.64	<u>5A</u>	<u>4D</u>		<a href="#">View</a>
Kitsap	<a href="#">Electricians - Powerline Construction</a>	Journey Level Lineperson	\$75.64	<u>5A</u>	<u>4D</u>		<a href="#">View</a>
Kitsap	<a href="#">Electricians - Powerline Construction</a>	Line Equipment Operator	\$64.54	<u>5A</u>	<u>4D</u>		<a href="#">View</a>
Kitsap	<a href="#">Electricians - Powerline Construction</a>	Meter Installer	\$49.17	<u>5A</u>	<u>4D</u>	<u>8W</u>	<a href="#">View</a>
Kitsap	<a href="#">Electricians - Powerline Construction</a>	Pole Sprayer	\$75.64	<u>5A</u>	<u>4D</u>		<a href="#">View</a>
Kitsap	<a href="#">Electricians - Powerline Construction</a>	Powderperson	\$56.49	<u>5A</u>	<u>4D</u>		<a href="#">View</a>
Kitsap	<a href="#">Electronic Technicians</a>	Journey Level	\$57.07	<u>7E</u>	<u>1E</u>		<a href="#">View</a>
Kitsap	<a href="#">Elevator Constructors</a>	Mechanic	\$100.51	<u>7D</u>	<u>4A</u>		<a href="#">View</a>
Kitsap	<a href="#">Elevator Constructors</a>	Mechanic In Charge	\$108.53	<u>7D</u>	<u>4A</u>		<a href="#">View</a>
Kitsap	<a href="#">Fabricated Precast Concrete Products</a>	Journey Level	\$14.49		<u>1</u>		<a href="#">View</a>
Kitsap	<a href="#">Fabricated Precast Concrete Products</a>	Journey Level - In-Factory Work Only	\$14.49		<u>1</u>		<a href="#">View</a>
Kitsap	<a href="#">Fence Erectors</a>	Fence Erector	\$46.29	<u>7A</u>	<u>4V</u>	<u>8Y</u>	<a href="#">View</a>
Kitsap	<a href="#">Fence Erectors</a>	Fence Laborer	\$46.29	<u>7A</u>	<u>4V</u>	<u>8Y</u>	<a href="#">View</a>
Kitsap	<a href="#">Flaggers</a>	Journey Level	\$46.29	<u>7A</u>	<u>4V</u>	<u>8Y</u>	<a href="#">View</a>
Kitsap	<a href="#">Glaziers</a>	Journey Level	\$72.41	<u>7L</u>	<u>1Y</u>		<a href="#">View</a>
Kitsap	<a href="#">Heat &amp; Frost Insulators And Asbestos Workers</a>	Journey Level	\$82.02	<u>15H</u>	<u>11C</u>		<a href="#">View</a>
Kitsap	<a href="#">Heating Equipment Mechanics</a>	Journey Level	\$91.83	<u>7F</u>	<u>1E</u>		<a href="#">View</a>
Kitsap	<a href="#">Hod Carriers &amp; Mason Tenders</a>	Journey Level	\$57.31	<u>7A</u>	<u>4V</u>	<u>8Y</u>	<a href="#">View</a>
Kitsap	<a href="#">Industrial Power Vacuum Cleaner</a>	Journey Level	\$29.89		<u>1</u>		<a href="#">View</a>
Kitsap	<a href="#">Inland Boatmen</a>	Boat Operator	\$61.41	<u>5B</u>	<u>1K</u>		<a href="#">View</a>
Kitsap	<a href="#">Inland Boatmen</a>	Cook	\$56.48	<u>5B</u>	<u>1K</u>		<a href="#">View</a>
Kitsap	<a href="#">Inland Boatmen</a>	Deckhand	\$57.48	<u>5B</u>	<u>1K</u>		<a href="#">View</a>
Kitsap	<a href="#">Inland Boatmen</a>	Deckhand Engineer	\$58.81	<u>5B</u>	<u>1K</u>		<a href="#">View</a>
Kitsap	<a href="#">Inland Boatmen</a>	Launch Operator	\$58.89	<u>5B</u>	<u>1K</u>		<a href="#">View</a>
Kitsap	<a href="#">Inland Boatmen</a>	Mate	\$57.31	<u>5B</u>	<u>1K</u>		<a href="#">View</a>
Kitsap	<a href="#">Inspection/Cleaning/Sealing Of Sewer &amp; Water Systems By Remote Control</a>	Cleaner Operator, Foamer Operator	\$14.49		<u>1</u>		<a href="#">View</a>

Kitsap	<a href="#">Inspection/Cleaning/Sealing Of Sewer &amp; Water Systems By Remote Control</a>	Grout Truck Operator	\$14.49		1		<a href="#">View</a>
Kitsap	<a href="#">Inspection/Cleaning/Sealing Of Sewer &amp; Water Systems By Remote Control</a>	Head Operator	\$14.49		1		<a href="#">View</a>
Kitsap	<a href="#">Inspection/Cleaning/Sealing Of Sewer &amp; Water Systems By Remote Control</a>	Tv Truck Operator	\$24.17		1		<a href="#">View</a>
Kitsap	<a href="#">Insulation Applicators</a>	Journey Level	\$68.19	<a href="#">7A</a>	<a href="#">4C</a>		<a href="#">View</a>
Kitsap	<a href="#">Ironworkers</a>	Journeyman	\$78.53	<a href="#">7N</a>	<a href="#">10</a>		<a href="#">View</a>
Kitsap	<a href="#">Laborers</a>	Air, Gas Or Electric Vibrating Screed	\$54.62	<a href="#">7A</a>	<a href="#">4V</a>	<a href="#">8Y</a>	<a href="#">View</a>
Kitsap	<a href="#">Laborers</a>	Airtrac Drill Operator	\$56.31	<a href="#">7A</a>	<a href="#">4V</a>	<a href="#">8Y</a>	<a href="#">View</a>
Kitsap	<a href="#">Laborers</a>	Ballast Regular Machine	\$54.62	<a href="#">7A</a>	<a href="#">4V</a>	<a href="#">8Y</a>	<a href="#">View</a>
Kitsap	<a href="#">Laborers</a>	Batch Weighman	\$46.29	<a href="#">7A</a>	<a href="#">4V</a>	<a href="#">8Y</a>	<a href="#">View</a>
Kitsap	<a href="#">Laborers</a>	Brick Pavers	\$54.62	<a href="#">7A</a>	<a href="#">4V</a>	<a href="#">8Y</a>	<a href="#">View</a>
Kitsap	<a href="#">Laborers</a>	Brush Cutter	\$54.62	<a href="#">7A</a>	<a href="#">4V</a>	<a href="#">8Y</a>	<a href="#">View</a>
Kitsap	<a href="#">Laborers</a>	Brush Hog Feeder	\$54.62	<a href="#">7A</a>	<a href="#">4V</a>	<a href="#">8Y</a>	<a href="#">View</a>
Kitsap	<a href="#">Laborers</a>	Burner	\$54.62	<a href="#">7A</a>	<a href="#">4V</a>	<a href="#">8Y</a>	<a href="#">View</a>
Kitsap	<a href="#">Laborers</a>	Caisson Worker	\$56.31	<a href="#">7A</a>	<a href="#">4V</a>	<a href="#">8Y</a>	<a href="#">View</a>
Kitsap	<a href="#">Laborers</a>	Carpenter Tender	\$54.62	<a href="#">7A</a>	<a href="#">4V</a>	<a href="#">8Y</a>	<a href="#">View</a>
Kitsap	<a href="#">Laborers</a>	Cement Dumper-paving	\$55.62	<a href="#">7A</a>	<a href="#">4V</a>	<a href="#">8Y</a>	<a href="#">View</a>
Kitsap	<a href="#">Laborers</a>	Cement Finisher Tender	\$54.62	<a href="#">7A</a>	<a href="#">4V</a>	<a href="#">8Y</a>	<a href="#">View</a>
Kitsap	<a href="#">Laborers</a>	Change House Or Dry Shack	\$54.62	<a href="#">7A</a>	<a href="#">4V</a>	<a href="#">8Y</a>	<a href="#">View</a>
Kitsap	<a href="#">Laborers</a>	Chipping Gun (30 Lbs. And Over)	\$55.62	<a href="#">7A</a>	<a href="#">4V</a>	<a href="#">8Y</a>	<a href="#">View</a>
Kitsap	<a href="#">Laborers</a>	Chipping Gun (Under 30 Lbs.)	\$54.62	<a href="#">7A</a>	<a href="#">4V</a>	<a href="#">8Y</a>	<a href="#">View</a>
Kitsap	<a href="#">Laborers</a>	Choker Setter	\$54.62	<a href="#">7A</a>	<a href="#">4V</a>	<a href="#">8Y</a>	<a href="#">View</a>
Kitsap	<a href="#">Laborers</a>	Chuck Tender	\$54.62	<a href="#">7A</a>	<a href="#">4V</a>	<a href="#">8Y</a>	<a href="#">View</a>
Kitsap	<a href="#">Laborers</a>	Clary Power Spreader	\$55.62	<a href="#">7A</a>	<a href="#">4V</a>	<a href="#">8Y</a>	<a href="#">View</a>
Kitsap	<a href="#">Laborers</a>	Clean-up Laborer	\$54.62	<a href="#">7A</a>	<a href="#">4V</a>	<a href="#">8Y</a>	<a href="#">View</a>
Kitsap	<a href="#">Laborers</a>	Concrete Dumper/Chute Operator	\$55.62	<a href="#">7A</a>	<a href="#">4V</a>	<a href="#">8Y</a>	<a href="#">View</a>
Kitsap	<a href="#">Laborers</a>	Concrete Form Stripper	\$54.62	<a href="#">7A</a>	<a href="#">4V</a>	<a href="#">8Y</a>	<a href="#">View</a>
Kitsap	<a href="#">Laborers</a>	Concrete Placement Crew	\$55.62	<a href="#">7A</a>	<a href="#">4V</a>	<a href="#">8Y</a>	<a href="#">View</a>
Kitsap	<a href="#">Laborers</a>	Concrete Saw Operator/Core Driller	\$55.62	<a href="#">7A</a>	<a href="#">4V</a>	<a href="#">8Y</a>	<a href="#">View</a>
Kitsap	<a href="#">Laborers</a>	Crusher Feeder	\$46.29	<a href="#">7A</a>	<a href="#">4V</a>	<a href="#">8Y</a>	<a href="#">View</a>
Kitsap	<a href="#">Laborers</a>	Curing Laborer	\$54.62	<a href="#">7A</a>	<a href="#">4V</a>	<a href="#">8Y</a>	<a href="#">View</a>
Kitsap	<a href="#">Laborers</a>	Demolition: Wrecking & Moving (Incl. Charred Material)	\$54.62	<a href="#">7A</a>	<a href="#">4V</a>	<a href="#">8Y</a>	<a href="#">View</a>
Kitsap	<a href="#">Laborers</a>	Ditch Digger	\$54.62	<a href="#">7A</a>	<a href="#">4V</a>	<a href="#">8Y</a>	<a href="#">View</a>
Kitsap	<a href="#">Laborers</a>	Diver	\$56.31	<a href="#">7A</a>	<a href="#">4V</a>	<a href="#">8Y</a>	<a href="#">View</a>
Kitsap	<a href="#">Laborers</a>	Drill Operator (Hydraulic, Diamond)	\$55.62	<a href="#">7A</a>	<a href="#">4V</a>	<a href="#">8Y</a>	<a href="#">View</a>
Kitsap	<a href="#">Laborers</a>	Dry Stack Walls	\$54.62	<a href="#">7A</a>	<a href="#">4V</a>	<a href="#">8Y</a>	<a href="#">View</a>
Kitsap	<a href="#">Laborers</a>	Dump Person	\$54.62	<a href="#">7A</a>	<a href="#">4V</a>	<a href="#">8Y</a>	<a href="#">View</a>
Kitsap	<a href="#">Laborers</a>	Epoxy Technician	\$54.62	<a href="#">7A</a>	<a href="#">4V</a>	<a href="#">8Y</a>	<a href="#">View</a>

Kitsap	<a href="#">Laborers</a>	Erosion Control Worker	\$54.62	<a href="#">7A</a>	<a href="#">4V</a>	<a href="#">8Y</a>	<a href="#">View</a>
Kitsap	<a href="#">Laborers</a>	Faller & Bucker Chain Saw	\$55.62	<a href="#">7A</a>	<a href="#">4V</a>	<a href="#">8Y</a>	<a href="#">View</a>
Kitsap	<a href="#">Laborers</a>	Fine Graders	\$54.62	<a href="#">7A</a>	<a href="#">4V</a>	<a href="#">8Y</a>	<a href="#">View</a>
Kitsap	<a href="#">Laborers</a>	Firewatch	\$46.29	<a href="#">7A</a>	<a href="#">4V</a>	<a href="#">8Y</a>	<a href="#">View</a>
Kitsap	<a href="#">Laborers</a>	Form Setter	\$54.62	<a href="#">7A</a>	<a href="#">4V</a>	<a href="#">8Y</a>	<a href="#">View</a>
Kitsap	<a href="#">Laborers</a>	Gabian Basket Builders	\$54.62	<a href="#">7A</a>	<a href="#">4V</a>	<a href="#">8Y</a>	<a href="#">View</a>
Kitsap	<a href="#">Laborers</a>	General Laborer	\$54.62	<a href="#">7A</a>	<a href="#">4V</a>	<a href="#">8Y</a>	<a href="#">View</a>
Kitsap	<a href="#">Laborers</a>	Grade Checker & Transit Person	\$57.31	<a href="#">7A</a>	<a href="#">4V</a>	<a href="#">8Y</a>	<a href="#">View</a>
Kitsap	<a href="#">Laborers</a>	Grinders	\$54.62	<a href="#">7A</a>	<a href="#">4V</a>	<a href="#">8Y</a>	<a href="#">View</a>
Kitsap	<a href="#">Laborers</a>	Grout Machine Tender	\$54.62	<a href="#">7A</a>	<a href="#">4V</a>	<a href="#">8Y</a>	<a href="#">View</a>
Kitsap	<a href="#">Laborers</a>	Groutmen (Pressure) Including Post Tension Beams	\$55.62	<a href="#">7A</a>	<a href="#">4V</a>	<a href="#">8Y</a>	<a href="#">View</a>
Kitsap	<a href="#">Laborers</a>	Guardrail Erector	\$54.62	<a href="#">7A</a>	<a href="#">4V</a>	<a href="#">8Y</a>	<a href="#">View</a>
Kitsap	<a href="#">Laborers</a>	Hazardous Waste Worker (Level A)	\$56.31	<a href="#">7A</a>	<a href="#">4V</a>	<a href="#">8Y</a>	<a href="#">View</a>
Kitsap	<a href="#">Laborers</a>	Hazardous Waste Worker (Level B)	\$55.62	<a href="#">7A</a>	<a href="#">4V</a>	<a href="#">8Y</a>	<a href="#">View</a>
Kitsap	<a href="#">Laborers</a>	Hazardous Waste Worker (Level C)	\$54.62	<a href="#">7A</a>	<a href="#">4V</a>	<a href="#">8Y</a>	<a href="#">View</a>
Kitsap	<a href="#">Laborers</a>	High Scaler	\$56.31	<a href="#">7A</a>	<a href="#">4V</a>	<a href="#">8Y</a>	<a href="#">View</a>
Kitsap	<a href="#">Laborers</a>	Jackhammer	\$55.62	<a href="#">7A</a>	<a href="#">4V</a>	<a href="#">8Y</a>	<a href="#">View</a>
Kitsap	<a href="#">Laborers</a>	Laserbeam Operator	\$55.62	<a href="#">7A</a>	<a href="#">4V</a>	<a href="#">8Y</a>	<a href="#">View</a>
Kitsap	<a href="#">Laborers</a>	Maintenance Person	\$54.62	<a href="#">7A</a>	<a href="#">4V</a>	<a href="#">8Y</a>	<a href="#">View</a>
Kitsap	<a href="#">Laborers</a>	Manhole Builder-Mudman	\$55.62	<a href="#">7A</a>	<a href="#">4V</a>	<a href="#">8Y</a>	<a href="#">View</a>
Kitsap	<a href="#">Laborers</a>	Material Yard Person	\$54.62	<a href="#">7A</a>	<a href="#">4V</a>	<a href="#">8Y</a>	<a href="#">View</a>
Kitsap	<a href="#">Laborers</a>	Motorman-Dinky Locomotive	\$55.62	<a href="#">7A</a>	<a href="#">4V</a>	<a href="#">8Y</a>	<a href="#">View</a>
Kitsap	<a href="#">Laborers</a>	nozzleman (concrete pump, green cutter when using combination of high pressure air & water on concrete & rock, sandblast, gunite, shotcrete, water blaster, vacuum blaster)	\$57.31	<a href="#">7A</a>	<a href="#">4V</a>	<a href="#">8Y</a>	<a href="#">View</a>
Kitsap	<a href="#">Laborers</a>	Pavement Breaker	\$55.62	<a href="#">7A</a>	<a href="#">4V</a>	<a href="#">8Y</a>	<a href="#">View</a>
Kitsap	<a href="#">Laborers</a>	Pilot Car	\$46.29	<a href="#">7A</a>	<a href="#">4V</a>	<a href="#">8Y</a>	<a href="#">View</a>
Kitsap	<a href="#">Laborers</a>	Pipe Layer (Lead)	\$57.31	<a href="#">7A</a>	<a href="#">4V</a>	<a href="#">8Y</a>	<a href="#">View</a>
Kitsap	<a href="#">Laborers</a>	Pipe Layer/Tailor	\$55.62	<a href="#">7A</a>	<a href="#">4V</a>	<a href="#">8Y</a>	<a href="#">View</a>
Kitsap	<a href="#">Laborers</a>	Pipe Pot Tender	\$55.62	<a href="#">7A</a>	<a href="#">4V</a>	<a href="#">8Y</a>	<a href="#">View</a>
Kitsap	<a href="#">Laborers</a>	Pipe Reliner	\$55.62	<a href="#">7A</a>	<a href="#">4V</a>	<a href="#">8Y</a>	<a href="#">View</a>
Kitsap	<a href="#">Laborers</a>	Pipe Wrapper	\$55.62	<a href="#">7A</a>	<a href="#">4V</a>	<a href="#">8Y</a>	<a href="#">View</a>
Kitsap	<a href="#">Laborers</a>	Pot Tender	\$54.62	<a href="#">7A</a>	<a href="#">4V</a>	<a href="#">8Y</a>	<a href="#">View</a>
Kitsap	<a href="#">Laborers</a>	Powderman	\$56.31	<a href="#">7A</a>	<a href="#">4V</a>	<a href="#">8Y</a>	<a href="#">View</a>
Kitsap	<a href="#">Laborers</a>	Powderman's Helper	\$54.62	<a href="#">7A</a>	<a href="#">4V</a>	<a href="#">8Y</a>	<a href="#">View</a>
Kitsap	<a href="#">Laborers</a>	Power Jacks	\$55.62	<a href="#">7A</a>	<a href="#">4V</a>	<a href="#">8Y</a>	<a href="#">View</a>
Kitsap	<a href="#">Laborers</a>	Railroad Spike Puller - Power	\$55.62	<a href="#">7A</a>	<a href="#">4V</a>	<a href="#">8Y</a>	<a href="#">View</a>
Kitsap	<a href="#">Laborers</a>	Raker - Asphalt	\$57.31	<a href="#">7A</a>	<a href="#">4V</a>	<a href="#">8Y</a>	<a href="#">View</a>
Kitsap	<a href="#">Laborers</a>	Re-timberman	\$56.31	<a href="#">7A</a>	<a href="#">4V</a>	<a href="#">8Y</a>	<a href="#">View</a>
Kitsap	<a href="#">Laborers</a>	Remote Equipment Operator	\$55.62	<a href="#">7A</a>	<a href="#">4V</a>	<a href="#">8Y</a>	<a href="#">View</a>
Kitsap	<a href="#">Laborers</a>	Rigger/Signal Person	\$55.62	<a href="#">7A</a>	<a href="#">4V</a>	<a href="#">8Y</a>	<a href="#">View</a>

Kitsap	<a href="#">Laborers</a>	Rip Rap Person	\$54.62	<a href="#">7A</a>	<a href="#">4V</a>	<a href="#">8Y</a>	<a href="#">View</a>
Kitsap	<a href="#">Laborers</a>	Rivet Buster	\$55.62	<a href="#">7A</a>	<a href="#">4V</a>	<a href="#">8Y</a>	<a href="#">View</a>
Kitsap	<a href="#">Laborers</a>	Rodder	\$55.62	<a href="#">7A</a>	<a href="#">4V</a>	<a href="#">8Y</a>	<a href="#">View</a>
Kitsap	<a href="#">Laborers</a>	Scaffold Erector	\$54.62	<a href="#">7A</a>	<a href="#">4V</a>	<a href="#">8Y</a>	<a href="#">View</a>
Kitsap	<a href="#">Laborers</a>	Scale Person	\$54.62	<a href="#">7A</a>	<a href="#">4V</a>	<a href="#">8Y</a>	<a href="#">View</a>
Kitsap	<a href="#">Laborers</a>	Sloper (Over 20")	\$55.62	<a href="#">7A</a>	<a href="#">4V</a>	<a href="#">8Y</a>	<a href="#">View</a>
Kitsap	<a href="#">Laborers</a>	Sloper Sprayer	\$54.62	<a href="#">7A</a>	<a href="#">4V</a>	<a href="#">8Y</a>	<a href="#">View</a>
Kitsap	<a href="#">Laborers</a>	Spreader (Concrete)	\$55.62	<a href="#">7A</a>	<a href="#">4V</a>	<a href="#">8Y</a>	<a href="#">View</a>
Kitsap	<a href="#">Laborers</a>	Stake Hopper	\$54.62	<a href="#">7A</a>	<a href="#">4V</a>	<a href="#">8Y</a>	<a href="#">View</a>
Kitsap	<a href="#">Laborers</a>	Stock Piler	\$54.62	<a href="#">7A</a>	<a href="#">4V</a>	<a href="#">8Y</a>	<a href="#">View</a>
Kitsap	<a href="#">Laborers</a>	Swinging Stage/Boatswain Chair	\$46.29	<a href="#">7A</a>	<a href="#">4V</a>	<a href="#">8Y</a>	<a href="#">View</a>
Kitsap	<a href="#">Laborers</a>	Tamper & Similar Electric, Air & Gas Operated Tools	\$55.62	<a href="#">7A</a>	<a href="#">4V</a>	<a href="#">8Y</a>	<a href="#">View</a>
Kitsap	<a href="#">Laborers</a>	Tamper (Multiple & Self-propelled)	\$55.62	<a href="#">7A</a>	<a href="#">4V</a>	<a href="#">8Y</a>	<a href="#">View</a>
Kitsap	<a href="#">Laborers</a>	Timber Person - Sewer (Lagger, Shorer & Cribber)	\$55.62	<a href="#">7A</a>	<a href="#">4V</a>	<a href="#">8Y</a>	<a href="#">View</a>
Kitsap	<a href="#">Laborers</a>	Toolroom Person (at Jobsite)	\$54.62	<a href="#">7A</a>	<a href="#">4V</a>	<a href="#">8Y</a>	<a href="#">View</a>
Kitsap	<a href="#">Laborers</a>	Topper	\$54.62	<a href="#">7A</a>	<a href="#">4V</a>	<a href="#">8Y</a>	<a href="#">View</a>
Kitsap	<a href="#">Laborers</a>	Track Laborer	\$54.62	<a href="#">7A</a>	<a href="#">4V</a>	<a href="#">8Y</a>	<a href="#">View</a>
Kitsap	<a href="#">Laborers</a>	Track Liner (Power)	\$55.62	<a href="#">7A</a>	<a href="#">4V</a>	<a href="#">8Y</a>	<a href="#">View</a>
Kitsap	<a href="#">Laborers</a>	Traffic Control Laborer	\$49.50	<a href="#">7A</a>	<a href="#">4V</a>	<a href="#">9C</a>	<a href="#">View</a>
Kitsap	<a href="#">Laborers</a>	Traffic Control Supervisor	\$52.45	<a href="#">7A</a>	<a href="#">4V</a>	<a href="#">9C</a>	<a href="#">View</a>
Kitsap	<a href="#">Laborers</a>	Truck Spotter	\$54.62	<a href="#">7A</a>	<a href="#">4V</a>	<a href="#">8Y</a>	<a href="#">View</a>
Kitsap	<a href="#">Laborers</a>	Tugger Operator	\$55.62	<a href="#">7A</a>	<a href="#">4V</a>	<a href="#">8Y</a>	<a href="#">View</a>
Kitsap	<a href="#">Laborers</a>	Tunnel Work-Compressed Air Worker 0-30 psi	\$142.82	<a href="#">7A</a>	<a href="#">4V</a>	<a href="#">9B</a>	<a href="#">View</a>
Kitsap	<a href="#">Laborers</a>	Tunnel Work-Compressed Air Worker 30.01-44.00 psi	\$147.85	<a href="#">7A</a>	<a href="#">4V</a>	<a href="#">9B</a>	<a href="#">View</a>
Kitsap	<a href="#">Laborers</a>	Tunnel Work-Compressed Air Worker 44.01-54.00 psi	\$151.53	<a href="#">7A</a>	<a href="#">4V</a>	<a href="#">9B</a>	<a href="#">View</a>
Kitsap	<a href="#">Laborers</a>	Tunnel Work-Compressed Air Worker 54.01-60.00 psi	\$157.23	<a href="#">7A</a>	<a href="#">4V</a>	<a href="#">9B</a>	<a href="#">View</a>
Kitsap	<a href="#">Laborers</a>	Tunnel Work-Compressed Air Worker 60.01-64.00 psi	\$159.35	<a href="#">7A</a>	<a href="#">4V</a>	<a href="#">9B</a>	<a href="#">View</a>
Kitsap	<a href="#">Laborers</a>	Tunnel Work-Compressed Air Worker 64.01-68.00 psi	\$164.45	<a href="#">7A</a>	<a href="#">4V</a>	<a href="#">9B</a>	<a href="#">View</a>
Kitsap	<a href="#">Laborers</a>	Tunnel Work-Compressed Air Worker 68.01-70.00 psi	\$166.35	<a href="#">7A</a>	<a href="#">4V</a>	<a href="#">9B</a>	<a href="#">View</a>
Kitsap	<a href="#">Laborers</a>	Tunnel Work-Compressed Air Worker 70.01-72.00 psi	\$168.35	<a href="#">7A</a>	<a href="#">4V</a>	<a href="#">9B</a>	<a href="#">View</a>
Kitsap	<a href="#">Laborers</a>	Tunnel Work-Compressed Air Worker 72.01-74.00 psi	\$170.35	<a href="#">7A</a>	<a href="#">4V</a>	<a href="#">9B</a>	<a href="#">View</a>
Kitsap	<a href="#">Laborers</a>	Tunnel Work-Guage and Lock Tender	\$57.41	<a href="#">7A</a>	<a href="#">4V</a>	<a href="#">8Y</a>	<a href="#">View</a>
Kitsap	<a href="#">Laborers</a>	Tunnel Work-Miner	\$57.41	<a href="#">7A</a>	<a href="#">4V</a>	<a href="#">8Y</a>	<a href="#">View</a>
Kitsap	<a href="#">Laborers</a>	Vibrator	\$55.62	<a href="#">7A</a>	<a href="#">4V</a>	<a href="#">8Y</a>	<a href="#">View</a>
Kitsap	<a href="#">Laborers</a>	Vinyl Seamer	\$54.62	<a href="#">7A</a>	<a href="#">4V</a>	<a href="#">8Y</a>	<a href="#">View</a>
Kitsap	<a href="#">Laborers</a>	Watchman	\$42.08	<a href="#">7A</a>	<a href="#">4V</a>	<a href="#">8Y</a>	<a href="#">View</a>

Kitsap	<a href="#">Laborers</a>	Welder	\$55.62	<a href="#">7A</a>	<a href="#">4V</a>	<a href="#">8Y</a>	<a href="#">View</a>
Kitsap	<a href="#">Laborers</a>	Well Point Laborer	\$55.62	<a href="#">7A</a>	<a href="#">4V</a>	<a href="#">8Y</a>	<a href="#">View</a>
Kitsap	<a href="#">Laborers</a>	Window Washer/Cleaner	\$42.08	<a href="#">7A</a>	<a href="#">4V</a>	<a href="#">8Y</a>	<a href="#">View</a>
Kitsap	<a href="#">Laborers - Underground Sewer &amp; Water</a>	General Laborer & Topman	\$54.62	<a href="#">7A</a>	<a href="#">4V</a>	<a href="#">8Y</a>	<a href="#">View</a>
Kitsap	<a href="#">Laborers - Underground Sewer &amp; Water</a>	Pipe Layer	\$55.62	<a href="#">7A</a>	<a href="#">4V</a>	<a href="#">8Y</a>	<a href="#">View</a>
Kitsap	<a href="#">Landscape Construction</a>	Landscape Construction/Landscaping Or Planting Laborers	\$42.08	<a href="#">7A</a>	<a href="#">4V</a>	<a href="#">8Y</a>	<a href="#">View</a>
Kitsap	<a href="#">Landscape Construction</a>	Landscape Operator	\$72.44	<a href="#">15J</a>	<a href="#">11G</a>	<a href="#">8X</a>	<a href="#">View</a>
Kitsap	<a href="#">Landscape Maintenance</a>	Groundskeeper	\$14.49		<a href="#">1</a>		<a href="#">View</a>
Kitsap	<a href="#">Lathers</a>	Journey Level	\$67.54	<a href="#">5D</a>	<a href="#">1H</a>		<a href="#">View</a>
Kitsap	<a href="#">Marble Setters</a>	Journey Level	\$63.32	<a href="#">7E</a>	<a href="#">1N</a>		<a href="#">View</a>
Kitsap	<a href="#">Metal Fabrication (In Shop)</a>	Fitter	\$26.96		<a href="#">1</a>		<a href="#">View</a>
Kitsap	<a href="#">Metal Fabrication (In Shop)</a>	Laborer	\$14.49		<a href="#">1</a>		<a href="#">View</a>
Kitsap	<a href="#">Metal Fabrication (In Shop)</a>	Machine Operator	\$14.49		<a href="#">1</a>		<a href="#">View</a>
Kitsap	<a href="#">Metal Fabrication (In Shop)</a>	Welder	\$14.49		<a href="#">1</a>		<a href="#">View</a>
Kitsap	<a href="#">Millwright</a>	Journey Level	\$69.64	<a href="#">7A</a>	<a href="#">4C</a>		<a href="#">View</a>
Kitsap	<a href="#">Modular Buildings</a>	Cabinet Assembly	\$14.49		<a href="#">1</a>		<a href="#">View</a>
Kitsap	<a href="#">Modular Buildings</a>	Electrician	\$14.49		<a href="#">1</a>		<a href="#">View</a>
Kitsap	<a href="#">Modular Buildings</a>	Equipment Maintenance	\$14.49		<a href="#">1</a>		<a href="#">View</a>
Kitsap	<a href="#">Modular Buildings</a>	Plumber	\$14.49		<a href="#">1</a>		<a href="#">View</a>
Kitsap	<a href="#">Modular Buildings</a>	Production Worker	\$14.49		<a href="#">1</a>		<a href="#">View</a>
Kitsap	<a href="#">Modular Buildings</a>	Tool Maintenance	\$14.49		<a href="#">1</a>		<a href="#">View</a>
Kitsap	<a href="#">Modular Buildings</a>	Utility Person	\$14.49		<a href="#">1</a>		<a href="#">View</a>
Kitsap	<a href="#">Modular Buildings</a>	Welder	\$14.49		<a href="#">1</a>		<a href="#">View</a>
Kitsap	<a href="#">Painters</a>	Journey Level	\$47.70	<a href="#">6Z</a>	<a href="#">2B</a>		<a href="#">View</a>
Kitsap	<a href="#">Pile Driver</a>	Crew Tender	\$62.69	<a href="#">7A</a>	<a href="#">4C</a>		<a href="#">View</a>
Kitsap	<a href="#">Pile Driver</a>	Crew Tender/Technician	\$62.69	<a href="#">7A</a>	<a href="#">4C</a>		<a href="#">View</a>
Kitsap	<a href="#">Pile Driver</a>	Hyperbaric Worker - Compressed Air Worker 0-30.00 PSI	\$85.00	<a href="#">7A</a>	<a href="#">4C</a>		<a href="#">View</a>
Kitsap	<a href="#">Pile Driver</a>	Hyperbaric Worker - Compressed Air Worker 30.01 - 44.00 PSI	\$90.00	<a href="#">7A</a>	<a href="#">4C</a>		<a href="#">View</a>
Kitsap	<a href="#">Pile Driver</a>	Hyperbaric Worker - Compressed Air Worker 44.01 - 54.00 PSI	\$94.00	<a href="#">7A</a>	<a href="#">4C</a>		<a href="#">View</a>
Kitsap	<a href="#">Pile Driver</a>	Hyperbaric Worker - Compressed Air Worker 54.01 - 60.00 PSI	\$99.00	<a href="#">7A</a>	<a href="#">4C</a>		<a href="#">View</a>
Kitsap	<a href="#">Pile Driver</a>	Hyperbaric Worker - Compressed Air Worker 60.01 - 64.00 PSI	\$101.50	<a href="#">7A</a>	<a href="#">4C</a>		<a href="#">View</a>
Kitsap	<a href="#">Pile Driver</a>	Hyperbaric Worker - Compressed Air Worker 64.01 - 68.00 PSI	\$106.50	<a href="#">7A</a>	<a href="#">4C</a>		<a href="#">View</a>
Kitsap	<a href="#">Pile Driver</a>	Hyperbaric Worker - Compressed Air Worker 68.01 - 70.00 PSI	\$108.50	<a href="#">7A</a>	<a href="#">4C</a>		<a href="#">View</a>

Kitsap	<a href="#">Pile Driver</a>	Hyperbaric Worker - Compressed Air Worker 70.01 - 72.00 PSI	\$110.50	<a href="#">7A</a>	<a href="#">4C</a>		<a href="#">View</a>
Kitsap	<a href="#">Pile Driver</a>	Hyperbaric Worker - Compressed Air Worker 72.01 - 74.00 PSI	\$112.50	<a href="#">7A</a>	<a href="#">4C</a>		<a href="#">View</a>
Kitsap	<a href="#">Pile Driver</a>	Journey Level	\$68.64	<a href="#">7A</a>	<a href="#">4C</a>		<a href="#">View</a>
Kitsap	<a href="#">Plasterers</a>	Journey Level	\$64.14	<a href="#">7Q</a>	<a href="#">1R</a>		<a href="#">View</a>
Kitsap	<a href="#">Plasterers</a>	Nozzleman	\$67.64	<a href="#">7Q</a>	<a href="#">1R</a>		<a href="#">View</a>
Kitsap	<a href="#">Playground &amp; Park Equipment Installers</a>	Journey Level	\$14.49		<a href="#">1</a>		<a href="#">View</a>
Kitsap	<a href="#">Plumbers &amp; Pipefitters</a>	Journey Level	\$80.97	<a href="#">5A</a>	<a href="#">1G</a>		<a href="#">View</a>
Kitsap	<a href="#">Power Equipment Operators</a>	Asphalt Plant Operators	\$73.65	<a href="#">15J</a>	<a href="#">11G</a>	<a href="#">8X</a>	<a href="#">View</a>
Kitsap	<a href="#">Power Equipment Operators</a>	Assistant Engineer	\$69.28	<a href="#">7A</a>	<a href="#">11H</a>	<a href="#">8X</a>	<a href="#">View</a>
Kitsap	<a href="#">Power Equipment Operators</a>	Barrier Machine (zipper)	\$73.00	<a href="#">15J</a>	<a href="#">11G</a>	<a href="#">8X</a>	<a href="#">View</a>
Kitsap	<a href="#">Power Equipment Operators</a>	Batch Plant Operator: concrete	\$73.00	<a href="#">15J</a>	<a href="#">11G</a>	<a href="#">8X</a>	<a href="#">View</a>
Kitsap	<a href="#">Power Equipment Operators</a>	Boat Operator	\$73.66	<a href="#">7A</a>	<a href="#">11H</a>	<a href="#">8X</a>	<a href="#">View</a>
Kitsap	<a href="#">Power Equipment Operators</a>	Bobcat	\$69.27	<a href="#">15J</a>	<a href="#">11G</a>	<a href="#">8X</a>	<a href="#">View</a>
Kitsap	<a href="#">Power Equipment Operators</a>	Brokk - Remote Demolition Equipment	\$69.27	<a href="#">15J</a>	<a href="#">11G</a>	<a href="#">8X</a>	<a href="#">View</a>
Kitsap	<a href="#">Power Equipment Operators</a>	Brooms	\$69.27	<a href="#">15J</a>	<a href="#">11G</a>	<a href="#">8X</a>	<a href="#">View</a>
Kitsap	<a href="#">Power Equipment Operators</a>	Bump Cutter	\$73.00	<a href="#">15J</a>	<a href="#">11G</a>	<a href="#">8X</a>	<a href="#">View</a>
Kitsap	<a href="#">Power Equipment Operators</a>	Cableways	\$73.65	<a href="#">15J</a>	<a href="#">11G</a>	<a href="#">8X</a>	<a href="#">View</a>
Kitsap	<a href="#">Power Equipment Operators</a>	Chipper	\$73.00	<a href="#">15J</a>	<a href="#">11G</a>	<a href="#">8X</a>	<a href="#">View</a>
Kitsap	<a href="#">Power Equipment Operators</a>	Compressor	\$69.27	<a href="#">15J</a>	<a href="#">11G</a>	<a href="#">8X</a>	<a href="#">View</a>
Kitsap	<a href="#">Power Equipment Operators</a>	Concrete Finish Machine - Laser Screed	\$69.27	<a href="#">15J</a>	<a href="#">11G</a>	<a href="#">8X</a>	<a href="#">View</a>
Kitsap	<a href="#">Power Equipment Operators</a>	Concrete Pump - Mounted Or Trailer High Pressure Line Pump, Pump High Pressure	\$72.44	<a href="#">15J</a>	<a href="#">11G</a>	<a href="#">8X</a>	<a href="#">View</a>
Kitsap	<a href="#">Power Equipment Operators</a>	Concrete Pump: Truck Mount With Boom Attachment Over 42 M	\$73.65	<a href="#">15J</a>	<a href="#">11G</a>	<a href="#">8X</a>	<a href="#">View</a>
Kitsap	<a href="#">Power Equipment Operators</a>	Concrete Pump: Truck Mount With Boom Attachment Up To 42m	\$73.00	<a href="#">15J</a>	<a href="#">11G</a>	<a href="#">8X</a>	<a href="#">View</a>
Kitsap	<a href="#">Power Equipment Operators</a>	Conveyors	\$72.44	<a href="#">15J</a>	<a href="#">11G</a>	<a href="#">8X</a>	<a href="#">View</a>
Kitsap	<a href="#">Power Equipment Operators</a>	Cranes Friction: 200 tons and over	\$75.90	<a href="#">7A</a>	<a href="#">11H</a>	<a href="#">8X</a>	<a href="#">View</a>
Kitsap	<a href="#">Power Equipment Operators</a>	Cranes, A-frame: 10 tons and under	\$69.28	<a href="#">7A</a>	<a href="#">11H</a>	<a href="#">8X</a>	<a href="#">View</a>
Kitsap	<a href="#">Power Equipment Operators</a>	Cranes: 100 tons through 199 tons, or 150' of boom (including jib with attachments)	\$74.40	<a href="#">7A</a>	<a href="#">11H</a>	<a href="#">8X</a>	<a href="#">View</a>
Kitsap	<a href="#">Power Equipment Operators</a>	Cranes: 20 tons through 44 tons with attachments	\$73.01	<a href="#">7A</a>	<a href="#">11H</a>	<a href="#">8X</a>	<a href="#">View</a>
Kitsap	<a href="#">Power Equipment Operators</a>	Cranes: 200 tons- 299 tons, or 250' of boom including jib with attachments	\$75.17	<a href="#">7A</a>	<a href="#">11H</a>	<a href="#">8X</a>	<a href="#">View</a>
Kitsap	<a href="#">Power Equipment Operators</a>	Cranes: 300 tons and over or 300' of boom including jib with	\$75.90	<a href="#">7A</a>	<a href="#">11H</a>	<a href="#">8X</a>	<a href="#">View</a>

		attachments					
Kitsap	<a href="#">Power Equipment Operators</a>	Cranes: 45 tons through 99 tons, under 150' of boom(including jib with attachments)	\$73.66	<a href="#">7A</a>	<a href="#">11H</a>	<a href="#">8X</a>	<a href="#">View</a>
Kitsap	<a href="#">Power Equipment Operators</a>	Cranes: Friction cranes through 199 tons	\$75.17	<a href="#">7A</a>	<a href="#">11H</a>	<a href="#">8X</a>	<a href="#">View</a>
Kitsap	<a href="#">Power Equipment Operators</a>	Cranes: through 19 tons with attachments, a-frame over 10 tons	\$72.45	<a href="#">7A</a>	<a href="#">11H</a>	<a href="#">8X</a>	<a href="#">View</a>
Kitsap	<a href="#">Power Equipment Operators</a>	Crusher	\$73.00	<a href="#">15J</a>	<a href="#">11G</a>	<a href="#">8X</a>	<a href="#">View</a>
Kitsap	<a href="#">Power Equipment Operators</a>	Deck Engineer/Deck Winches (power)	\$73.00	<a href="#">15J</a>	<a href="#">11G</a>	<a href="#">8X</a>	<a href="#">View</a>
Kitsap	<a href="#">Power Equipment Operators</a>	Derricks, On Building Work	\$73.65	<a href="#">15J</a>	<a href="#">11G</a>	<a href="#">8X</a>	<a href="#">View</a>
Kitsap	<a href="#">Power Equipment Operators</a>	Dozers D-9 & Under	\$72.44	<a href="#">15J</a>	<a href="#">11G</a>	<a href="#">8X</a>	<a href="#">View</a>
Kitsap	<a href="#">Power Equipment Operators</a>	Drill Oilers: Auger Type, Truck Or Crane Mount	\$72.44	<a href="#">15J</a>	<a href="#">11G</a>	<a href="#">8X</a>	<a href="#">View</a>
Kitsap	<a href="#">Power Equipment Operators</a>	Drilling Machine	\$74.39	<a href="#">15J</a>	<a href="#">11G</a>	<a href="#">8X</a>	<a href="#">View</a>
Kitsap	<a href="#">Power Equipment Operators</a>	Elevator and man-lift: permanent and shaft type	\$69.28	<a href="#">7A</a>	<a href="#">11H</a>	<a href="#">8X</a>	<a href="#">View</a>
Kitsap	<a href="#">Power Equipment Operators</a>	Finishing Machine, Bidwell And Gamaco & Similar Equipment	\$73.00	<a href="#">15J</a>	<a href="#">11G</a>	<a href="#">8X</a>	<a href="#">View</a>
Kitsap	<a href="#">Power Equipment Operators</a>	Forklift: 3000 lbs and over with attachments	\$72.45	<a href="#">7A</a>	<a href="#">11H</a>	<a href="#">8X</a>	<a href="#">View</a>
Kitsap	<a href="#">Power Equipment Operators</a>	Forklifts: under 3000 lbs. with attachments	\$69.28	<a href="#">7A</a>	<a href="#">11H</a>	<a href="#">8X</a>	<a href="#">View</a>
Kitsap	<a href="#">Power Equipment Operators</a>	Grade Engineer: Using Blue Prints, Cut Sheets, Etc	\$73.00	<a href="#">15J</a>	<a href="#">11G</a>	<a href="#">8X</a>	<a href="#">View</a>
Kitsap	<a href="#">Power Equipment Operators</a>	Gradechecker/Stakeman	\$69.27	<a href="#">15J</a>	<a href="#">11G</a>	<a href="#">8X</a>	<a href="#">View</a>
Kitsap	<a href="#">Power Equipment Operators</a>	Guardrail Punch	\$73.00	<a href="#">15J</a>	<a href="#">11G</a>	<a href="#">8X</a>	<a href="#">View</a>
Kitsap	<a href="#">Power Equipment Operators</a>	Hard Tail End Dump Articulating Off- Road Equipment 45 Yards. & Over	\$73.65	<a href="#">15J</a>	<a href="#">11G</a>	<a href="#">8X</a>	<a href="#">View</a>
Kitsap	<a href="#">Power Equipment Operators</a>	Hard Tail End Dump Articulating Off-road Equipment Under 45 Yards	\$73.00	<a href="#">15J</a>	<a href="#">11G</a>	<a href="#">8X</a>	<a href="#">View</a>
Kitsap	<a href="#">Power Equipment Operators</a>	Horizontal/Directional Drill Locator	\$72.44	<a href="#">15J</a>	<a href="#">11G</a>	<a href="#">8X</a>	<a href="#">View</a>
Kitsap	<a href="#">Power Equipment Operators</a>	Horizontal/Directional Drill Operator	\$73.00	<a href="#">15J</a>	<a href="#">11G</a>	<a href="#">8X</a>	<a href="#">View</a>
Kitsap	<a href="#">Power Equipment Operators</a>	Hydralifts/Boom Trucks Over 10 Tons	\$72.45	<a href="#">7A</a>	<a href="#">11H</a>	<a href="#">8X</a>	<a href="#">View</a>
Kitsap	<a href="#">Power Equipment Operators</a>	Hydralifts/boom trucks: 10 tons and under	\$69.28	<a href="#">7A</a>	<a href="#">11H</a>	<a href="#">8X</a>	<a href="#">View</a>
Kitsap	<a href="#">Power Equipment Operators</a>	Leverman	\$75.17	<a href="#">7A</a>	<a href="#">11H</a>	<a href="#">8X</a>	<a href="#">View</a>
Kitsap	<a href="#">Power Equipment Operators</a>	Loader, Overhead, 6 Yards. But Not Including 8 Yards	\$73.65	<a href="#">15J</a>	<a href="#">11G</a>	<a href="#">8X</a>	<a href="#">View</a>
Kitsap	<a href="#">Power Equipment Operators</a>	Loaders, Overhead Under 6 Yards	\$73.00	<a href="#">15J</a>	<a href="#">11G</a>	<a href="#">8X</a>	<a href="#">View</a>
Kitsap	<a href="#">Power Equipment Operators</a>	Loaders, Plant Feed	\$73.00	<a href="#">15J</a>	<a href="#">11G</a>	<a href="#">8X</a>	<a href="#">View</a>
Kitsap	<a href="#">Power Equipment Operators</a>	Loaders: Elevating Type Belt	\$72.44	<a href="#">15J</a>	<a href="#">11G</a>	<a href="#">8X</a>	<a href="#">View</a>
Kitsap	<a href="#">Power Equipment Operators</a>	Locomotives, All	\$73.00	<a href="#">15J</a>	<a href="#">11G</a>	<a href="#">8X</a>	<a href="#">View</a>

Kitsap	<a href="#">Power Equipment Operators</a>	Material Transfer Device	\$73.00	<a href="#">15J</a>	<a href="#">11G</a>	<a href="#">8X</a>	<a href="#">View</a>
Kitsap	<a href="#">Power Equipment Operators</a>	Mechanics: all (Leadmen - \$0.50 per hour over mechanic)	\$74.40	<a href="#">7A</a>	<a href="#">11H</a>	<a href="#">8X</a>	<a href="#">View</a>
Kitsap	<a href="#">Power Equipment Operators</a>	Motor Patrol Graders	\$73.65	<a href="#">15J</a>	<a href="#">11G</a>	<a href="#">8X</a>	<a href="#">View</a>
Kitsap	<a href="#">Power Equipment Operators</a>	Mucking Machine, Mole, Tunnel Drill, Boring, Road Header And/or Shield	\$73.65	<a href="#">15J</a>	<a href="#">11G</a>	<a href="#">8X</a>	<a href="#">View</a>
Kitsap	<a href="#">Power Equipment Operators</a>	Oil Distributors, Blower Distribution & Mulch Seeding Operator	\$69.27	<a href="#">15J</a>	<a href="#">11G</a>	<a href="#">8X</a>	<a href="#">View</a>
Kitsap	<a href="#">Power Equipment Operators</a>	Outside Hoists (elevators and manlifts), Air Tuggers, Strato	\$72.45	<a href="#">7A</a>	<a href="#">11H</a>	<a href="#">8X</a>	<a href="#">View</a>
Kitsap	<a href="#">Power Equipment Operators</a>	Overhead, bridge type: 100 tons and over	\$74.40	<a href="#">7A</a>	<a href="#">11H</a>	<a href="#">8X</a>	<a href="#">View</a>
Kitsap	<a href="#">Power Equipment Operators</a>	Overhead, bridge type: 45 tons through 99 tons	\$73.66	<a href="#">7A</a>	<a href="#">11H</a>	<a href="#">8X</a>	<a href="#">View</a>
Kitsap	<a href="#">Power Equipment Operators</a>	Pavement Breaker	\$69.27	<a href="#">15J</a>	<a href="#">11G</a>	<a href="#">8X</a>	<a href="#">View</a>
Kitsap	<a href="#">Power Equipment Operators</a>	Pile Driver (other Than Crane Mount)	\$73.00	<a href="#">15J</a>	<a href="#">11G</a>	<a href="#">8X</a>	<a href="#">View</a>
Kitsap	<a href="#">Power Equipment Operators</a>	Plant Oiler - Asphalt, Crusher	\$72.44	<a href="#">15J</a>	<a href="#">11G</a>	<a href="#">8X</a>	<a href="#">View</a>
Kitsap	<a href="#">Power Equipment Operators</a>	Posthole Digger, Mechanical	\$69.27	<a href="#">15J</a>	<a href="#">11G</a>	<a href="#">8X</a>	<a href="#">View</a>
Kitsap	<a href="#">Power Equipment Operators</a>	Power Plant	\$69.27	<a href="#">15J</a>	<a href="#">11G</a>	<a href="#">8X</a>	<a href="#">View</a>
Kitsap	<a href="#">Power Equipment Operators</a>	Pumps - Water	\$69.27	<a href="#">15J</a>	<a href="#">11G</a>	<a href="#">8X</a>	<a href="#">View</a>
Kitsap	<a href="#">Power Equipment Operators</a>	Quad 9, Hd 41, D10 And Over	\$73.65	<a href="#">15J</a>	<a href="#">11G</a>	<a href="#">8X</a>	<a href="#">View</a>
Kitsap	<a href="#">Power Equipment Operators</a>	Remote Control Operator On Rubber Tired Earth Moving Equipment	\$73.65	<a href="#">15J</a>	<a href="#">11G</a>	<a href="#">8X</a>	<a href="#">View</a>
Kitsap	<a href="#">Power Equipment Operators</a>	Rigger and Bellman	\$69.28	<a href="#">7A</a>	<a href="#">11H</a>	<a href="#">8X</a>	<a href="#">View</a>
Kitsap	<a href="#">Power Equipment Operators</a>	Rigger/Signal Person, Bellman(Certified)	\$72.45	<a href="#">7A</a>	<a href="#">11H</a>	<a href="#">8X</a>	<a href="#">View</a>
Kitsap	<a href="#">Power Equipment Operators</a>	Rollagon	\$73.65	<a href="#">15J</a>	<a href="#">11G</a>	<a href="#">8X</a>	<a href="#">View</a>
Kitsap	<a href="#">Power Equipment Operators</a>	Roller, Other Than Plant Mix	\$69.27	<a href="#">15J</a>	<a href="#">11G</a>	<a href="#">8X</a>	<a href="#">View</a>
Kitsap	<a href="#">Power Equipment Operators</a>	Roller, Plant Mix Or Multi-lift Materials	\$72.44	<a href="#">15J</a>	<a href="#">11G</a>	<a href="#">8X</a>	<a href="#">View</a>
Kitsap	<a href="#">Power Equipment Operators</a>	Roto-mill, Roto-grinder	\$73.00	<a href="#">15J</a>	<a href="#">11G</a>	<a href="#">8X</a>	<a href="#">View</a>
Kitsap	<a href="#">Power Equipment Operators</a>	Saws - Concrete	\$72.44	<a href="#">15J</a>	<a href="#">11G</a>	<a href="#">8X</a>	<a href="#">View</a>
Kitsap	<a href="#">Power Equipment Operators</a>	Scraper, Self Propelled Under 45 Yards	\$73.00	<a href="#">15J</a>	<a href="#">11G</a>	<a href="#">8X</a>	<a href="#">View</a>
Kitsap	<a href="#">Power Equipment Operators</a>	Scrapers - Concrete & Carry All	\$72.44	<a href="#">15J</a>	<a href="#">11G</a>	<a href="#">8X</a>	<a href="#">View</a>
Kitsap	<a href="#">Power Equipment Operators</a>	Scrapers, Self-propelled: 45 Yards And Over	\$73.65	<a href="#">15J</a>	<a href="#">11G</a>	<a href="#">8X</a>	<a href="#">View</a>
Kitsap	<a href="#">Power Equipment Operators</a>	Service Engineers: equipment	\$72.45	<a href="#">7A</a>	<a href="#">11H</a>	<a href="#">8X</a>	<a href="#">View</a>
Kitsap	<a href="#">Power Equipment Operators</a>	Shotcrete/Gunite Equipment	\$69.27	<a href="#">15J</a>	<a href="#">11G</a>	<a href="#">8X</a>	<a href="#">View</a>
Kitsap	<a href="#">Power Equipment Operators</a>	Shovel, Excavator, Backhoe, Tractors Under 15 Metric Tons	\$72.44	<a href="#">15J</a>	<a href="#">11G</a>	<a href="#">8X</a>	<a href="#">View</a>
Kitsap	<a href="#">Power Equipment Operators</a>	Shovel, Excavator, Backhoe: Over 30 Metric Tons To 50 Metric Tons	\$73.65	<a href="#">15J</a>	<a href="#">11G</a>	<a href="#">8X</a>	<a href="#">View</a>
Kitsap	<a href="#">Power Equipment Operators</a>	Shovel, Excavator, Backhoes, Tractors: 15 To 30 Metric Tons	\$73.00	<a href="#">15J</a>	<a href="#">11G</a>	<a href="#">8X</a>	<a href="#">View</a>
Kitsap	<a href="#">Power Equipment Operators</a>	Shovel, Excavator, Backhoes:	\$74.39	<a href="#">15J</a>	<a href="#">11G</a>	<a href="#">8X</a>	<a href="#">View</a>



		Over 50 Metric Tons To 90 Metric Tons					
Kitsap	<a href="#">Power Equipment Operators</a>	Shovel, Excavator, Backhoes: Over 90 Metric Tons	\$75.15	<a href="#">15J</a>	<a href="#">11G</a>	<a href="#">8X</a>	<a href="#">View</a>
Kitsap	<a href="#">Power Equipment Operators</a>	Slipform Pavers	\$73.65	<a href="#">15J</a>	<a href="#">11G</a>	<a href="#">8X</a>	<a href="#">View</a>
Kitsap	<a href="#">Power Equipment Operators</a>	Spreader, Toppersider & Screedman	\$73.65	<a href="#">15J</a>	<a href="#">11G</a>	<a href="#">8X</a>	<a href="#">View</a>
Kitsap	<a href="#">Power Equipment Operators</a>	Subgrader Trimmer	\$73.00	<a href="#">15J</a>	<a href="#">11G</a>	<a href="#">8X</a>	<a href="#">View</a>
Kitsap	<a href="#">Power Equipment Operators</a>	Tower Bucket Elevators	\$72.44	<a href="#">15J</a>	<a href="#">11G</a>	<a href="#">8X</a>	<a href="#">View</a>
Kitsap	<a href="#">Power Equipment Operators</a>	Tower Crane: over 175' through 250' in height, base to boom	\$75.17	<a href="#">7A</a>	<a href="#">11H</a>	<a href="#">8X</a>	<a href="#">View</a>
Kitsap	<a href="#">Power Equipment Operators</a>	Tower crane: up to 175' in height base to boom	\$74.40	<a href="#">7A</a>	<a href="#">11H</a>	<a href="#">8X</a>	<a href="#">View</a>
Kitsap	<a href="#">Power Equipment Operators</a>	Tower Cranes: over 250' in height from base to boom	\$75.90	<a href="#">7A</a>	<a href="#">11H</a>	<a href="#">8X</a>	<a href="#">View</a>
Kitsap	<a href="#">Power Equipment Operators</a>	Transporters, All Track Or Truck Type	\$73.65	<a href="#">15J</a>	<a href="#">11G</a>	<a href="#">8X</a>	<a href="#">View</a>
Kitsap	<a href="#">Power Equipment Operators</a>	Trenching Machines	\$72.44	<a href="#">15J</a>	<a href="#">11G</a>	<a href="#">8X</a>	<a href="#">View</a>
Kitsap	<a href="#">Power Equipment Operators</a>	Truck crane oiler/driver: under 100 tons	\$72.45	<a href="#">7A</a>	<a href="#">11H</a>	<a href="#">8X</a>	<a href="#">View</a>
Kitsap	<a href="#">Power Equipment Operators</a>	Truck Mount Portable Conveyor	\$73.00	<a href="#">15J</a>	<a href="#">11G</a>	<a href="#">8X</a>	<a href="#">View</a>
Kitsap	<a href="#">Power Equipment Operators</a>	Welder	\$73.66	<a href="#">7A</a>	<a href="#">11H</a>	<a href="#">8X</a>	<a href="#">View</a>
Kitsap	<a href="#">Power Equipment Operators</a>	Wheel Tractors, Farmall Type	\$69.27	<a href="#">15J</a>	<a href="#">11G</a>	<a href="#">8X</a>	<a href="#">View</a>
Kitsap	<a href="#">Power Equipment Operators</a>	Yo Yo Pay Dozer	\$73.00	<a href="#">15J</a>	<a href="#">11G</a>	<a href="#">8X</a>	<a href="#">View</a>
Kitsap	<a href="#">Power Equipment Operators-Underground Sewer &amp; Water</a>	Asphalt Plant Operators	\$73.65	<a href="#">15J</a>	<a href="#">11G</a>	<a href="#">8X</a>	<a href="#">View</a>
Kitsap	<a href="#">Power Equipment Operators-Underground Sewer &amp; Water</a>	Assistant Engineer	\$69.28	<a href="#">7A</a>	<a href="#">11H</a>	<a href="#">8X</a>	<a href="#">View</a>
Kitsap	<a href="#">Power Equipment Operators-Underground Sewer &amp; Water</a>	Barrier Machine (zipper)	\$73.00	<a href="#">15J</a>	<a href="#">11G</a>	<a href="#">8X</a>	<a href="#">View</a>
Kitsap	<a href="#">Power Equipment Operators-Underground Sewer &amp; Water</a>	Batch Plant Operator, Concrete	\$73.00	<a href="#">15J</a>	<a href="#">11G</a>	<a href="#">8X</a>	<a href="#">View</a>
Kitsap	<a href="#">Power Equipment Operators-Underground Sewer &amp; Water</a>	Boat Operator	\$73.66	<a href="#">7A</a>	<a href="#">11H</a>	<a href="#">8X</a>	<a href="#">View</a>
Kitsap	<a href="#">Power Equipment Operators-Underground Sewer &amp; Water</a>	Bobcat	\$69.27	<a href="#">15J</a>	<a href="#">11G</a>	<a href="#">8X</a>	<a href="#">View</a>
Kitsap	<a href="#">Power Equipment Operators-Underground Sewer &amp; Water</a>	Brokk - Remote Demolition Equipment	\$69.27	<a href="#">15J</a>	<a href="#">11G</a>	<a href="#">8X</a>	<a href="#">View</a>
Kitsap	<a href="#">Power Equipment Operators-Underground Sewer &amp; Water</a>	Brooms	\$69.27	<a href="#">15J</a>	<a href="#">11G</a>	<a href="#">8X</a>	<a href="#">View</a>
Kitsap	<a href="#">Power Equipment Operators-Underground Sewer &amp; Water</a>	Bump Cutter	\$73.00	<a href="#">15J</a>	<a href="#">11G</a>	<a href="#">8X</a>	<a href="#">View</a>
Kitsap	<a href="#">Power Equipment Operators-Underground Sewer &amp; Water</a>	Cableways	\$73.65	<a href="#">15J</a>	<a href="#">11G</a>	<a href="#">8X</a>	<a href="#">View</a>
Kitsap	<a href="#">Power Equipment Operators-Underground Sewer &amp; Water</a>	Chipper	\$73.00	<a href="#">15J</a>	<a href="#">11G</a>	<a href="#">8X</a>	<a href="#">View</a>
Kitsap	<a href="#">Power Equipment Operators-Underground Sewer &amp; Water</a>	Compressor	\$69.27	<a href="#">15J</a>	<a href="#">11G</a>	<a href="#">8X</a>	<a href="#">View</a>
Kitsap	<a href="#">Power Equipment Operators-Underground Sewer &amp; Water</a>	Concrete Finish Machine - Laser Screed	\$69.27	<a href="#">15J</a>	<a href="#">11G</a>	<a href="#">8X</a>	<a href="#">View</a>
Kitsap	<a href="#">Power Equipment Operators-Underground Sewer &amp; Water</a>	Concrete Pump - Mounted Or Trailer High Pressure Line	\$72.44	<a href="#">15J</a>	<a href="#">11G</a>	<a href="#">8X</a>	<a href="#">View</a>

		Pump, Pump High Pressure					
Kitsap	<a href="#">Power Equipment Operators-Underground Sewer &amp; Water</a>	Concrete Pump: Truck Mount With Boom Attachment Over 42 M	\$73.65	<a href="#">15J</a>	<a href="#">11G</a>	<a href="#">8X</a>	<a href="#">View</a>
Kitsap	<a href="#">Power Equipment Operators-Underground Sewer &amp; Water</a>	Concrete Pump: Truck Mount With Boom Attachment Up To 42m	\$73.00	<a href="#">15J</a>	<a href="#">11G</a>	<a href="#">8X</a>	<a href="#">View</a>
Kitsap	<a href="#">Power Equipment Operators-Underground Sewer &amp; Water</a>	Conveyors	\$72.44	<a href="#">15J</a>	<a href="#">11G</a>	<a href="#">8X</a>	<a href="#">View</a>
Kitsap	<a href="#">Power Equipment Operators-Underground Sewer &amp; Water</a>	Cranes Friction: 200 tons and over	\$75.90	<a href="#">7A</a>	<a href="#">11H</a>	<a href="#">8X</a>	<a href="#">View</a>
Kitsap	<a href="#">Power Equipment Operators-Underground Sewer &amp; Water</a>	Cranes, A-frame: 10 tons and under	\$69.28	<a href="#">7A</a>	<a href="#">11H</a>	<a href="#">8X</a>	<a href="#">View</a>
Kitsap	<a href="#">Power Equipment Operators-Underground Sewer &amp; Water</a>	Cranes: 100 tons through 199 tons, or 150' of boom (including jib with attachments)	\$74.40	<a href="#">7A</a>	<a href="#">11H</a>	<a href="#">8X</a>	<a href="#">View</a>
Kitsap	<a href="#">Power Equipment Operators-Underground Sewer &amp; Water</a>	Cranes: 20 tons through 44 tons with attachments	\$73.01	<a href="#">7A</a>	<a href="#">11H</a>	<a href="#">8X</a>	<a href="#">View</a>
Kitsap	<a href="#">Power Equipment Operators-Underground Sewer &amp; Water</a>	Cranes: 20 tons through 44 tons with attachments	\$73.01	<a href="#">7A</a>	<a href="#">11H</a>	<a href="#">8X</a>	<a href="#">View</a>
Kitsap	<a href="#">Power Equipment Operators-Underground Sewer &amp; Water</a>	Cranes: 200 tons- 299 tons, or 250' of boom including jib with attachments	\$75.17	<a href="#">7A</a>	<a href="#">11H</a>	<a href="#">8X</a>	<a href="#">View</a>
Kitsap	<a href="#">Power Equipment Operators-Underground Sewer &amp; Water</a>	Cranes: 300 tons and over or 300' of boom including jib with attachments	\$75.90	<a href="#">7A</a>	<a href="#">11H</a>	<a href="#">8X</a>	<a href="#">View</a>
Kitsap	<a href="#">Power Equipment Operators-Underground Sewer &amp; Water</a>	Cranes: 45 tons through 99 tons, under 150' of boom(including jib with attachments)	\$73.66	<a href="#">7A</a>	<a href="#">11H</a>	<a href="#">8X</a>	<a href="#">View</a>
Kitsap	<a href="#">Power Equipment Operators-Underground Sewer &amp; Water</a>	Cranes: Friction cranes through 199 tons	\$75.17	<a href="#">7A</a>	<a href="#">11H</a>	<a href="#">8X</a>	<a href="#">View</a>
Kitsap	<a href="#">Power Equipment Operators-Underground Sewer &amp; Water</a>	Cranes: through 19 tons with attachments, a-frame over 10 tons	\$72.45	<a href="#">7A</a>	<a href="#">11H</a>	<a href="#">8X</a>	<a href="#">View</a>
Kitsap	<a href="#">Power Equipment Operators-Underground Sewer &amp; Water</a>	Crusher	\$73.00	<a href="#">15J</a>	<a href="#">11G</a>	<a href="#">8X</a>	<a href="#">View</a>
Kitsap	<a href="#">Power Equipment Operators-Underground Sewer &amp; Water</a>	Deck Engineer/Deck Winches (power)	\$73.00	<a href="#">15J</a>	<a href="#">11G</a>	<a href="#">8X</a>	<a href="#">View</a>
Kitsap	<a href="#">Power Equipment Operators-Underground Sewer &amp; Water</a>	Derricks, On Building Work	\$73.65	<a href="#">15J</a>	<a href="#">11G</a>	<a href="#">8X</a>	<a href="#">View</a>
Kitsap	<a href="#">Power Equipment Operators-Underground Sewer &amp; Water</a>	Dozers D-9 & Under	\$72.44	<a href="#">15J</a>	<a href="#">11G</a>	<a href="#">8X</a>	<a href="#">View</a>
Kitsap	<a href="#">Power Equipment Operators-Underground Sewer &amp; Water</a>	Drill Oilers: Auger Type, Truck Or Crane Mount	\$72.44	<a href="#">15J</a>	<a href="#">11G</a>	<a href="#">8X</a>	<a href="#">View</a>
Kitsap	<a href="#">Power Equipment Operators-Underground Sewer &amp; Water</a>	Drilling Machine	\$74.39	<a href="#">15J</a>	<a href="#">11G</a>	<a href="#">8X</a>	<a href="#">View</a>
Kitsap	<a href="#">Power Equipment Operators-Underground Sewer &amp; Water</a>	Elevator and man-lift: permanent and shaft type	\$69.28	<a href="#">7A</a>	<a href="#">11H</a>	<a href="#">8X</a>	<a href="#">View</a>
Kitsap	<a href="#">Power Equipment Operators-Underground Sewer &amp; Water</a>	Finishing Machine, Bidwell And Gamaco & Similar Equipment	\$73.00	<a href="#">15J</a>	<a href="#">11G</a>	<a href="#">8X</a>	<a href="#">View</a>
Kitsap	<a href="#">Power Equipment Operators-Underground Sewer &amp; Water</a>	Forklift: 3000 lbs and over with attachments	\$72.45	<a href="#">7A</a>	<a href="#">11H</a>	<a href="#">8X</a>	<a href="#">View</a>

Kitsap	<a href="#">Power Equipment Operators-Underground Sewer &amp; Water</a>	Forklifts: under 3000 lbs. with attachments	\$69.28	<a href="#">7A</a>	<a href="#">11H</a>	<a href="#">8X</a>	<a href="#">View</a>
Kitsap	<a href="#">Power Equipment Operators-Underground Sewer &amp; Water</a>	Grade Engineer: Using Blue Prints, Cut Sheets, Etc	\$73.00	<a href="#">15J</a>	<a href="#">11G</a>	<a href="#">8X</a>	<a href="#">View</a>
Kitsap	<a href="#">Power Equipment Operators-Underground Sewer &amp; Water</a>	Gradechecker/Stakeman	\$69.27	<a href="#">15J</a>	<a href="#">11G</a>	<a href="#">8X</a>	<a href="#">View</a>
Kitsap	<a href="#">Power Equipment Operators-Underground Sewer &amp; Water</a>	Guardrail Punch	\$73.00	<a href="#">15J</a>	<a href="#">11G</a>	<a href="#">8X</a>	<a href="#">View</a>
Kitsap	<a href="#">Power Equipment Operators-Underground Sewer &amp; Water</a>	Hard Tail End Dump Articulating Off- Road Equipment 45 Yards. & Over	\$73.65	<a href="#">15J</a>	<a href="#">11G</a>	<a href="#">8X</a>	<a href="#">View</a>
Kitsap	<a href="#">Power Equipment Operators-Underground Sewer &amp; Water</a>	Hard Tail End Dump Articulating Off-road Equipment Under 45 Yards	\$73.00	<a href="#">15J</a>	<a href="#">11G</a>	<a href="#">8X</a>	<a href="#">View</a>
Kitsap	<a href="#">Power Equipment Operators-Underground Sewer &amp; Water</a>	Horizontal/Directional Drill Locator	\$72.44	<a href="#">15J</a>	<a href="#">11G</a>	<a href="#">8X</a>	<a href="#">View</a>
Kitsap	<a href="#">Power Equipment Operators-Underground Sewer &amp; Water</a>	Horizontal/Directional Drill Operator	\$73.00	<a href="#">15J</a>	<a href="#">11G</a>	<a href="#">8X</a>	<a href="#">View</a>
Kitsap	<a href="#">Power Equipment Operators-Underground Sewer &amp; Water</a>	Hydralifts/boom trucks: 10 tons and under	\$69.28	<a href="#">7A</a>	<a href="#">11H</a>	<a href="#">8X</a>	<a href="#">View</a>
Kitsap	<a href="#">Power Equipment Operators-Underground Sewer &amp; Water</a>	Hydralifts/boom trucks: over 10 tons	\$72.45	<a href="#">7A</a>	<a href="#">11H</a>	<a href="#">8X</a>	<a href="#">View</a>
Kitsap	<a href="#">Power Equipment Operators-Underground Sewer &amp; Water</a>	Leverman	\$75.17	<a href="#">7A</a>	<a href="#">11H</a>	<a href="#">8X</a>	<a href="#">View</a>
Kitsap	<a href="#">Power Equipment Operators-Underground Sewer &amp; Water</a>	Loader, Overhead, 6 Yards. But Not Including 8 Yards	\$73.65	<a href="#">15J</a>	<a href="#">11G</a>	<a href="#">8X</a>	<a href="#">View</a>
Kitsap	<a href="#">Power Equipment Operators-Underground Sewer &amp; Water</a>	Loaders, Overhead Under 6 Yards	\$73.00	<a href="#">15J</a>	<a href="#">11G</a>	<a href="#">8X</a>	<a href="#">View</a>
Kitsap	<a href="#">Power Equipment Operators-Underground Sewer &amp; Water</a>	Loaders, Plant Feed	\$73.00	<a href="#">15J</a>	<a href="#">11G</a>	<a href="#">8X</a>	<a href="#">View</a>
Kitsap	<a href="#">Power Equipment Operators-Underground Sewer &amp; Water</a>	Loaders: Elevating Type Belt	\$72.44	<a href="#">15J</a>	<a href="#">11G</a>	<a href="#">8X</a>	<a href="#">View</a>
Kitsap	<a href="#">Power Equipment Operators-Underground Sewer &amp; Water</a>	Locomotives, All	\$73.00	<a href="#">15J</a>	<a href="#">11G</a>	<a href="#">8X</a>	<a href="#">View</a>
Kitsap	<a href="#">Power Equipment Operators-Underground Sewer &amp; Water</a>	Material Transfer Device	\$73.00	<a href="#">15J</a>	<a href="#">11G</a>	<a href="#">8X</a>	<a href="#">View</a>
Kitsap	<a href="#">Power Equipment Operators-Underground Sewer &amp; Water</a>	Mechanics: all (Leadmen - \$0.50 per hour over mechanic)	\$74.40	<a href="#">7A</a>	<a href="#">11H</a>	<a href="#">8X</a>	<a href="#">View</a>
Kitsap	<a href="#">Power Equipment Operators-Underground Sewer &amp; Water</a>	Motor Patrol Graders	\$73.65	<a href="#">15J</a>	<a href="#">11G</a>	<a href="#">8X</a>	<a href="#">View</a>
Kitsap	<a href="#">Power Equipment Operators-Underground Sewer &amp; Water</a>	Mucking Machine, Mole, Tunnel Drill, Boring, Road Header And/or Shield	\$73.65	<a href="#">15J</a>	<a href="#">11G</a>	<a href="#">8X</a>	<a href="#">View</a>
Kitsap	<a href="#">Power Equipment Operators-Underground Sewer &amp; Water</a>	Oil Distributors, Blower Distribution & Mulch Seeding Operator	\$69.27	<a href="#">15J</a>	<a href="#">11G</a>	<a href="#">8X</a>	<a href="#">View</a>
Kitsap	<a href="#">Power Equipment Operators-Underground Sewer &amp; Water</a>	Outside Hoists (elevators and manlifts), Air Tuggers, Strato	\$72.45	<a href="#">7A</a>	<a href="#">11H</a>	<a href="#">8X</a>	<a href="#">View</a>
Kitsap	<a href="#">Power Equipment Operators-Underground Sewer &amp; Water</a>	Overhead, bridge type: 100 tons and over	\$74.40	<a href="#">7A</a>	<a href="#">11H</a>	<a href="#">8X</a>	<a href="#">View</a>
Kitsap	<a href="#">Power Equipment Operators-Underground Sewer &amp; Water</a>	Overhead, bridge type: 45 tons through 99 tons	\$73.66	<a href="#">7A</a>	<a href="#">11H</a>	<a href="#">8X</a>	<a href="#">View</a>
Kitsap	<a href="#">Power Equipment Operators-</a>	Pavement Breaker	\$69.27	<a href="#">15J</a>	<a href="#">11G</a>	<a href="#">8X</a>	<a href="#">View</a>

	<a href="#">Underground Sewer &amp; Water</a>						
Kitsap	<a href="#">Power Equipment Operators-Underground Sewer &amp; Water</a>	Pile Driver (other Than Crane Mount)	\$73.00	<a href="#">15J</a>	<a href="#">11G</a>	<a href="#">8X</a>	<a href="#">View</a>
Kitsap	<a href="#">Power Equipment Operators-Underground Sewer &amp; Water</a>	Plant Oiler - Asphalt, Crusher	\$72.44	<a href="#">15J</a>	<a href="#">11G</a>	<a href="#">8X</a>	<a href="#">View</a>
Kitsap	<a href="#">Power Equipment Operators-Underground Sewer &amp; Water</a>	Posthole Digger, Mechanical	\$69.27	<a href="#">15J</a>	<a href="#">11G</a>	<a href="#">8X</a>	<a href="#">View</a>
Kitsap	<a href="#">Power Equipment Operators-Underground Sewer &amp; Water</a>	Power Plant	\$69.27	<a href="#">15J</a>	<a href="#">11G</a>	<a href="#">8X</a>	<a href="#">View</a>
Kitsap	<a href="#">Power Equipment Operators-Underground Sewer &amp; Water</a>	Pumps - Water	\$69.27	<a href="#">15J</a>	<a href="#">11G</a>	<a href="#">8X</a>	<a href="#">View</a>
Kitsap	<a href="#">Power Equipment Operators-Underground Sewer &amp; Water</a>	Quad 9, Hd 41, D10 And Over	\$73.65	<a href="#">15J</a>	<a href="#">11G</a>	<a href="#">8X</a>	<a href="#">View</a>
Kitsap	<a href="#">Power Equipment Operators-Underground Sewer &amp; Water</a>	Remote Control Operator On Rubber Tired Earth Moving Equipment	\$73.65	<a href="#">15J</a>	<a href="#">11G</a>	<a href="#">8X</a>	<a href="#">View</a>
Kitsap	<a href="#">Power Equipment Operators-Underground Sewer &amp; Water</a>	Rigger and Bellman	\$69.28	<a href="#">7A</a>	<a href="#">11H</a>	<a href="#">8X</a>	<a href="#">View</a>
Kitsap	<a href="#">Power Equipment Operators-Underground Sewer &amp; Water</a>	Rigger/Signal Person, Bellman(Certified)	\$72.45	<a href="#">7A</a>	<a href="#">11H</a>	<a href="#">8X</a>	<a href="#">View</a>
Kitsap	<a href="#">Power Equipment Operators-Underground Sewer &amp; Water</a>	Rollagon	\$73.65	<a href="#">15J</a>	<a href="#">11G</a>	<a href="#">8X</a>	<a href="#">View</a>
Kitsap	<a href="#">Power Equipment Operators-Underground Sewer &amp; Water</a>	Roller, Other Than Plant Mix	\$69.27	<a href="#">15J</a>	<a href="#">11G</a>	<a href="#">8X</a>	<a href="#">View</a>
Kitsap	<a href="#">Power Equipment Operators-Underground Sewer &amp; Water</a>	Roller, Plant Mix Or Multi-lift Materials	\$72.44	<a href="#">15J</a>	<a href="#">11G</a>	<a href="#">8X</a>	<a href="#">View</a>
Kitsap	<a href="#">Power Equipment Operators-Underground Sewer &amp; Water</a>	Roto-mill, Roto-grinder	\$73.00	<a href="#">15J</a>	<a href="#">11G</a>	<a href="#">8X</a>	<a href="#">View</a>
Kitsap	<a href="#">Power Equipment Operators-Underground Sewer &amp; Water</a>	Saws - Concrete	\$72.44	<a href="#">15J</a>	<a href="#">11G</a>	<a href="#">8X</a>	<a href="#">View</a>
Kitsap	<a href="#">Power Equipment Operators-Underground Sewer &amp; Water</a>	Scraper, Self Propelled Under 45 Yards	\$73.00	<a href="#">15J</a>	<a href="#">11G</a>	<a href="#">8X</a>	<a href="#">View</a>
Kitsap	<a href="#">Power Equipment Operators-Underground Sewer &amp; Water</a>	Scrapers - Concrete & Carry All	\$72.44	<a href="#">15J</a>	<a href="#">11G</a>	<a href="#">8X</a>	<a href="#">View</a>
Kitsap	<a href="#">Power Equipment Operators-Underground Sewer &amp; Water</a>	Scrapers, Self-propelled: 45 Yards And Over	\$73.65	<a href="#">15J</a>	<a href="#">11G</a>	<a href="#">8X</a>	<a href="#">View</a>
Kitsap	<a href="#">Power Equipment Operators-Underground Sewer &amp; Water</a>	Service Engineers: equipment	\$72.45	<a href="#">7A</a>	<a href="#">11H</a>	<a href="#">8X</a>	<a href="#">View</a>
Kitsap	<a href="#">Power Equipment Operators-Underground Sewer &amp; Water</a>	Shotcrete/Gunite Equipment	\$69.27	<a href="#">15J</a>	<a href="#">11G</a>	<a href="#">8X</a>	<a href="#">View</a>
Kitsap	<a href="#">Power Equipment Operators-Underground Sewer &amp; Water</a>	Shovel, Excavator, Backhoe, Tractors Under 15 Metric Tons	\$72.44	<a href="#">15J</a>	<a href="#">11G</a>	<a href="#">8X</a>	<a href="#">View</a>
Kitsap	<a href="#">Power Equipment Operators-Underground Sewer &amp; Water</a>	Shovel, Excavator, Backhoe: Over 30 Metric Tons To 50 Metric Tons	\$73.65	<a href="#">15J</a>	<a href="#">11G</a>	<a href="#">8X</a>	<a href="#">View</a>
Kitsap	<a href="#">Power Equipment Operators-Underground Sewer &amp; Water</a>	Shovel, Excavator, Backhoes, Tractors: 15 To 30 Metric Tons	\$73.00	<a href="#">15J</a>	<a href="#">11G</a>	<a href="#">8X</a>	<a href="#">View</a>
Kitsap	<a href="#">Power Equipment Operators-Underground Sewer &amp; Water</a>	Shovel, Excavator, Backhoes: Over 50 Metric Tons To 90 Metric Tons	\$74.39	<a href="#">15J</a>	<a href="#">11G</a>	<a href="#">8X</a>	<a href="#">View</a>
Kitsap	<a href="#">Power Equipment Operators-Underground Sewer &amp; Water</a>	Shovel, Excavator, Backhoes: Over 90 Metric Tons	\$75.15	<a href="#">15J</a>	<a href="#">11G</a>	<a href="#">8X</a>	<a href="#">View</a>
Kitsap	<a href="#">Power Equipment Operators-</a>	Slipform Pavers	\$73.65	<a href="#">15J</a>	<a href="#">11G</a>	<a href="#">8X</a>	<a href="#">View</a>

	<a href="#">Underground Sewer &amp; Water</a>						
Kitsap	<a href="#">Power Equipment Operators-Underground Sewer &amp; Water</a>	Spreader, Topsider & Screedman	\$73.65	<a href="#">15J</a>	<a href="#">11G</a>	<a href="#">8X</a>	<a href="#">View</a>
Kitsap	<a href="#">Power Equipment Operators-Underground Sewer &amp; Water</a>	Subgrader Trimmer	\$73.00	<a href="#">15J</a>	<a href="#">11G</a>	<a href="#">8X</a>	<a href="#">View</a>
Kitsap	<a href="#">Power Equipment Operators-Underground Sewer &amp; Water</a>	Tower Bucket Elevators	\$72.44	<a href="#">15J</a>	<a href="#">11G</a>	<a href="#">8X</a>	<a href="#">View</a>
Kitsap	<a href="#">Power Equipment Operators-Underground Sewer &amp; Water</a>	Tower Crane: over 175' through 250' in height, base to boom	\$75.17	<a href="#">7A</a>	<a href="#">11H</a>	<a href="#">8X</a>	<a href="#">View</a>
Kitsap	<a href="#">Power Equipment Operators-Underground Sewer &amp; Water</a>	Tower crane: up to 175' in height base to boom	\$74.40	<a href="#">7A</a>	<a href="#">11H</a>	<a href="#">8X</a>	<a href="#">View</a>
Kitsap	<a href="#">Power Equipment Operators-Underground Sewer &amp; Water</a>	Tower Cranes: over 250' in height from base to boom	\$75.90	<a href="#">7A</a>	<a href="#">11H</a>	<a href="#">8X</a>	<a href="#">View</a>
Kitsap	<a href="#">Power Equipment Operators-Underground Sewer &amp; Water</a>	Transporters, All Track Or Truck Type	\$73.65	<a href="#">15J</a>	<a href="#">11G</a>	<a href="#">8X</a>	<a href="#">View</a>
Kitsap	<a href="#">Power Equipment Operators-Underground Sewer &amp; Water</a>	Trenching Machines	\$72.44	<a href="#">15J</a>	<a href="#">11G</a>	<a href="#">8X</a>	<a href="#">View</a>
Kitsap	<a href="#">Power Equipment Operators-Underground Sewer &amp; Water</a>	Truck Crane Oiler/Driver: 100 tons and over	\$73.01	<a href="#">7A</a>	<a href="#">11H</a>	<a href="#">8X</a>	<a href="#">View</a>
Kitsap	<a href="#">Power Equipment Operators-Underground Sewer &amp; Water</a>	Truck crane oiler/driver: under 100 tons	\$72.45	<a href="#">7A</a>	<a href="#">11H</a>	<a href="#">8X</a>	<a href="#">View</a>
Kitsap	<a href="#">Power Equipment Operators-Underground Sewer &amp; Water</a>	Truck Mount Portable Conveyor	\$73.00	<a href="#">15J</a>	<a href="#">11G</a>	<a href="#">8X</a>	<a href="#">View</a>
Kitsap	<a href="#">Power Equipment Operators-Underground Sewer &amp; Water</a>	Welder	\$73.66	<a href="#">7A</a>	<a href="#">11H</a>	<a href="#">8X</a>	<a href="#">View</a>
Kitsap	<a href="#">Power Equipment Operators-Underground Sewer &amp; Water</a>	Wheel Tractors, Farmall Type	\$69.27	<a href="#">15J</a>	<a href="#">11G</a>	<a href="#">8X</a>	<a href="#">View</a>
Kitsap	<a href="#">Power Equipment Operators-Underground Sewer &amp; Water</a>	Yo Yo Pay Dozer	\$73.00	<a href="#">15J</a>	<a href="#">11G</a>	<a href="#">8X</a>	<a href="#">View</a>
Kitsap	<a href="#">Power Line Clearance Tree Trimmers</a>	Journey Level In Charge	\$55.03	<a href="#">5A</a>	<a href="#">4A</a>		<a href="#">View</a>
Kitsap	<a href="#">Power Line Clearance Tree Trimmers</a>	Spray Person	\$52.24	<a href="#">5A</a>	<a href="#">4A</a>		<a href="#">View</a>
Kitsap	<a href="#">Power Line Clearance Tree Trimmers</a>	Tree Equipment Operator	\$55.03	<a href="#">5A</a>	<a href="#">4A</a>		<a href="#">View</a>
Kitsap	<a href="#">Power Line Clearance Tree Trimmers</a>	Tree Trimmer	\$49.21	<a href="#">5A</a>	<a href="#">4A</a>		<a href="#">View</a>
Kitsap	<a href="#">Power Line Clearance Tree Trimmers</a>	Tree Trimmer Groundperson	\$37.47	<a href="#">5A</a>	<a href="#">4A</a>		<a href="#">View</a>
Kitsap	<a href="#">Refrigeration &amp; Air Conditioning Mechanics</a>	Journey Level	\$80.96	<a href="#">5A</a>	<a href="#">1G</a>		<a href="#">View</a>
Kitsap	<a href="#">Residential Brick Mason</a>	Journey Level	\$22.01		<a href="#">1</a>		<a href="#">View</a>
Kitsap	<a href="#">Residential Carpenters</a>	Journey Level	\$26.25		<a href="#">1</a>		<a href="#">View</a>
Kitsap	<a href="#">Residential Cement Masons</a>	Journey Level	\$39.88		<a href="#">1</a>		<a href="#">View</a>
Kitsap	<a href="#">Residential Drywall Applicators</a>	Journey Level	\$48.17	<a href="#">7A</a>	<a href="#">4C</a>		<a href="#">View</a>
Kitsap	<a href="#">Residential Drywall Tapers</a>	Journey Level	\$25.84		<a href="#">1</a>		<a href="#">View</a>
Kitsap	<a href="#">Residential Electricians</a>	Journey Level	\$44.11		<a href="#">1</a>		<a href="#">View</a>
Kitsap	<a href="#">Residential Glaziers</a>	Journey Level	\$47.80	<a href="#">7L</a>	<a href="#">1H</a>		<a href="#">View</a>
Kitsap	<a href="#">Residential Insulation Applicators</a>	Journey Level	\$18.03		<a href="#">1</a>		<a href="#">View</a>
Kitsap	<a href="#">Residential Laborers</a>	Journey Level	\$14.71		<a href="#">1</a>		<a href="#">View</a>

Kitsap	<a href="#">Residential Marble Setters</a>	Journey Level	\$22.01		<u>1</u>		<a href="#">View</a>
Kitsap	<a href="#">Residential Painters</a>	Journey Level	\$20.85		<u>1</u>		<a href="#">View</a>
Kitsap	<a href="#">Residential Plumbers &amp; Pipefitters</a>	Journey Level	\$35.92		<u>1</u>		<a href="#">View</a>
Kitsap	<a href="#">Residential Refrigeration &amp; Air Conditioning Mechanics</a>	Journey Level	\$40.21		<u>1</u>		<a href="#">View</a>
Kitsap	<a href="#">Residential Sheet Metal Workers</a>	Journey Level	\$32.91		<u>1</u>		<a href="#">View</a>
Kitsap	<a href="#">Residential Soft Floor Layers</a>	Journey Level	\$22.03		<u>1</u>		<a href="#">View</a>
Kitsap	<a href="#">Residential Sprinkler Fitters (Fire Protection)</a>	Journey Level	\$31.53		<u>1</u>		<a href="#">View</a>
Kitsap	<a href="#">Residential Stone Masons</a>	Journey Level	\$63.32	<u>7E</u>	<u>1N</u>		<a href="#">View</a>
Kitsap	<a href="#">Residential Terrazzo Workers</a>	Journey Level	\$14.86		<u>1</u>		<a href="#">View</a>
Kitsap	<a href="#">Residential Terrazzo/Tile Finishers</a>	Journey Level	\$39.09		<u>1</u>		<a href="#">View</a>
Kitsap	<a href="#">Residential Tile Setters</a>	Journey Level	\$35.40		<u>1</u>		<a href="#">View</a>
Kitsap	<a href="#">Roofers</a>	Journey Level	\$57.30	<u>5A</u>	<u>3H</u>		<a href="#">View</a>
Kitsap	<a href="#">Roofers</a>	Using Irritable Bituminous Materials	\$60.30	<u>5A</u>	<u>3H</u>		<a href="#">View</a>
Kitsap	<a href="#">Sheet Metal Workers</a>	Journey Level (Field or Shop)	\$91.83	<u>7F</u>	<u>1E</u>		<a href="#">View</a>
Kitsap	<a href="#">Shipbuilding &amp; Ship Repair</a>	New Construction Boilermaker	\$39.58	<u>7V</u>	<u>1</u>		<a href="#">View</a>
Kitsap	<a href="#">Shipbuilding &amp; Ship Repair</a>	New Construction Carpenter	\$39.58	<u>7V</u>	<u>1</u>		<a href="#">View</a>
Kitsap	<a href="#">Shipbuilding &amp; Ship Repair</a>	New Construction Crane Operator	\$39.58	<u>7V</u>	<u>1</u>		<a href="#">View</a>
Kitsap	<a href="#">Shipbuilding &amp; Ship Repair</a>	New Construction Electrician	\$39.58	<u>7V</u>	<u>1</u>		<a href="#">View</a>
Kitsap	<a href="#">Shipbuilding &amp; Ship Repair</a>	New Construction Heat & Frost Insulator	\$82.02	<u>15H</u>	<u>11C</u>		<a href="#">View</a>
Kitsap	<a href="#">Shipbuilding &amp; Ship Repair</a>	New Construction Laborer	\$39.58	<u>7V</u>	<u>1</u>		<a href="#">View</a>
Kitsap	<a href="#">Shipbuilding &amp; Ship Repair</a>	New Construction Machinist	\$39.58	<u>7V</u>	<u>1</u>		<a href="#">View</a>
Kitsap	<a href="#">Shipbuilding &amp; Ship Repair</a>	New Construction Operating Engineer	\$39.58	<u>7V</u>	<u>1</u>		<a href="#">View</a>
Kitsap	<a href="#">Shipbuilding &amp; Ship Repair</a>	New Construction Painter	\$39.58	<u>7V</u>	<u>1</u>		<a href="#">View</a>
Kitsap	<a href="#">Shipbuilding &amp; Ship Repair</a>	New Construction Pipefitter	\$39.58	<u>7V</u>	<u>1</u>		<a href="#">View</a>
Kitsap	<a href="#">Shipbuilding &amp; Ship Repair</a>	New Construction Rigger	\$39.58	<u>7V</u>	<u>1</u>		<a href="#">View</a>
Kitsap	<a href="#">Shipbuilding &amp; Ship Repair</a>	New Construction Sheet Metal	\$39.58	<u>7V</u>	<u>1</u>		<a href="#">View</a>
Kitsap	<a href="#">Shipbuilding &amp; Ship Repair</a>	New Construction Shipfitter	\$39.58	<u>7V</u>	<u>1</u>		<a href="#">View</a>
Kitsap	<a href="#">Shipbuilding &amp; Ship Repair</a>	New Construction Warehouse/Teamster	\$39.58	<u>7V</u>	<u>1</u>		<a href="#">View</a>
Kitsap	<a href="#">Shipbuilding &amp; Ship Repair</a>	New Construction Welder / Burner	\$39.58	<u>7V</u>	<u>1</u>		<a href="#">View</a>
Kitsap	<a href="#">Shipbuilding &amp; Ship Repair</a>	Ship Repair Boilermaker	\$47.45	<u>7X</u>	<u>4J</u>		<a href="#">View</a>
Kitsap	<a href="#">Shipbuilding &amp; Ship Repair</a>	Ship Repair Carpenter	\$47.35	<u>7X</u>	<u>4J</u>		<a href="#">View</a>
Kitsap	<a href="#">Shipbuilding &amp; Ship Repair</a>	Ship Repair Crane Operator	\$45.06	<u>7Y</u>	<u>4K</u>		<a href="#">View</a>
Kitsap	<a href="#">Shipbuilding &amp; Ship Repair</a>	Ship Repair Electrician	\$47.42	<u>7X</u>	<u>4J</u>		<a href="#">View</a>
Kitsap	<a href="#">Shipbuilding &amp; Ship Repair</a>	Ship Repair Heat & Frost Insulator	\$82.02	<u>15H</u>	<u>11C</u>		<a href="#">View</a>
Kitsap	<a href="#">Shipbuilding &amp; Ship Repair</a>	Ship Repair Laborer	\$47.35	<u>7X</u>	<u>4J</u>		<a href="#">View</a>
Kitsap	<a href="#">Shipbuilding &amp; Ship Repair</a>	Ship Repair Machinist	\$47.35	<u>7X</u>	<u>4J</u>		<a href="#">View</a>
Kitsap	<a href="#">Shipbuilding &amp; Ship Repair</a>	Ship Repair Operating Engineer	\$45.06	<u>7Y</u>	<u>4K</u>		<a href="#">View</a>

Kitsap	<a href="#">Shipbuilding &amp; Ship Repair</a>	Ship Repair Painter	\$47.35	<u>7X</u>	<u>4J</u>		<a href="#">View</a>
Kitsap	<a href="#">Shipbuilding &amp; Ship Repair</a>	Ship Repair Pipefitter	\$47.35	<u>7X</u>	<u>4J</u>		<a href="#">View</a>
Kitsap	<a href="#">Shipbuilding &amp; Ship Repair</a>	Ship Repair Rigger	\$47.45	<u>7X</u>	<u>4J</u>		<a href="#">View</a>
Kitsap	<a href="#">Shipbuilding &amp; Ship Repair</a>	Ship Repair Sheet Metal	\$47.35	<u>7X</u>	<u>4J</u>		<a href="#">View</a>
Kitsap	<a href="#">Shipbuilding &amp; Ship Repair</a>	Ship Repair Shipwright	\$47.35	<u>7X</u>	<u>4J</u>		<a href="#">View</a>
Kitsap	<a href="#">Shipbuilding &amp; Ship Repair</a>	Ship Repair Warehouse / Teamster	\$45.06	<u>7Y</u>	<u>4K</u>		<a href="#">View</a>
Kitsap	<a href="#">Sign Makers &amp; Installers (Electrical)</a>	Journey Level	\$53.62	<u>0</u>	<u>1</u>		<a href="#">View</a>
Kitsap	<a href="#">Sign Makers &amp; Installers (Non-Electrical)</a>	Journey Level	\$34.43	<u>0</u>	<u>1</u>		<a href="#">View</a>
Kitsap	<a href="#">Soft Floor Layers</a>	Journey Level	\$51.91	<u>5A</u>	<u>3J</u>		<a href="#">View</a>
Kitsap	<a href="#">Solar Controls For Windows</a>	Journey Level	\$14.49		<u>1</u>		<a href="#">View</a>
Kitsap	<a href="#">Sprinkler Fitters (Fire Protection)</a>	Journey Level	\$87.99	<u>5C</u>	<u>1X</u>		<a href="#">View</a>
Kitsap	<a href="#">Stage Rigging Mechanics (Non Structural)</a>	Journey Level	\$14.49		<u>1</u>		<a href="#">View</a>
Kitsap	<a href="#">Stone Masons</a>	Journey Level	\$63.32	<u>7E</u>	<u>1N</u>		<a href="#">View</a>
Kitsap	<a href="#">Street And Parking Lot Sweeper Workers</a>	Journey Level	\$16.00		<u>1</u>		<a href="#">View</a>
Kitsap	<a href="#">Surveyors</a>	Assistant Construction Site Surveyor	\$72.45	<u>7A</u>	<u>11H</u>	<u>8X</u>	<a href="#">View</a>
Kitsap	<a href="#">Surveyors</a>	Chainman	\$69.28	<u>7A</u>	<u>11H</u>	<u>8X</u>	<a href="#">View</a>
Kitsap	<a href="#">Surveyors</a>	Construction Site Surveyor	\$73.66	<u>7A</u>	<u>11H</u>	<u>8X</u>	<a href="#">View</a>
Kitsap	<a href="#">Surveyors</a>	Drone Operator (when used in conjunction with survey work only)	\$69.28	<u>7A</u>	<u>11H</u>	<u>8X</u>	<a href="#">View</a>
Kitsap	<a href="#">Telecommunication Technicians</a>	Journey Level	\$57.07	<u>7E</u>	<u>1E</u>		<a href="#">View</a>
Kitsap	<a href="#">Telephone Line Construction - Outside</a>	Cable Splicer	\$38.27	<u>5A</u>	<u>2B</u>		<a href="#">View</a>
Kitsap	<a href="#">Telephone Line Construction - Outside</a>	Hole Digger/Ground Person	\$25.66	<u>5A</u>	<u>2B</u>		<a href="#">View</a>
Kitsap	<a href="#">Telephone Line Construction - Outside</a>	Telephone Equipment Operator (Light)	\$31.96	<u>5A</u>	<u>2B</u>		<a href="#">View</a>
Kitsap	<a href="#">Telephone Line Construction - Outside</a>	Telephone Lineperson	\$36.17	<u>5A</u>	<u>2B</u>		<a href="#">View</a>
Kitsap	<a href="#">Terrazzo Workers</a>	Journey Level	\$57.71	<u>7E</u>	<u>1N</u>		<a href="#">View</a>
Kitsap	<a href="#">Tile Setters</a>	Journey Level	\$57.71	<u>7E</u>	<u>1N</u>		<a href="#">View</a>
Kitsap	<a href="#">Tile, Marble &amp; Terrazzo Finishers</a>	Finisher	\$48.54	<u>7E</u>	<u>1N</u>		<a href="#">View</a>
Kitsap	<a href="#">Traffic Control Stripers</a>	Journey Level	\$50.51	<u>7A</u>	<u>1K</u>		<a href="#">View</a>
Kitsap	<a href="#">Truck Drivers</a>	Asphalt Mix Over 16 Yards	\$69.20	<u>15J</u>	<u>11I</u>	<u>8L</u>	<a href="#">View</a>
Kitsap	<a href="#">Truck Drivers</a>	Asphalt Mix To 16 Yards	\$68.36	<u>15J</u>	<u>11I</u>	<u>8L</u>	<a href="#">View</a>
Kitsap	<a href="#">Truck Drivers</a>	Dump Truck	\$68.36	<u>15J</u>	<u>11I</u>	<u>8L</u>	<a href="#">View</a>
Kitsap	<a href="#">Truck Drivers</a>	Dump Truck & Trailer	\$69.20	<u>15J</u>	<u>11I</u>	<u>8L</u>	<a href="#">View</a>
Kitsap	<a href="#">Truck Drivers</a>	Other Trucks	\$69.20	<u>15J</u>	<u>11I</u>	<u>8L</u>	<a href="#">View</a>
Kitsap	<a href="#">Truck Drivers - Ready Mix</a>	Transit Mix	\$69.20	<u>15J</u>	<u>11I</u>	<u>8L</u>	<a href="#">View</a>
Kitsap	<a href="#">Well Drillers &amp; Irrigation Pump Installers</a>	Irrigation Pump Installer	\$14.49		<u>1</u>		<a href="#">View</a>
Kitsap	<a href="#">Well Drillers &amp; Irrigation Pump</a>	Oiler	\$14.49		<u>1</u>		<a href="#">View</a>

	<a href="#">Installers</a>					
Kitsap	<a href="#">Well Drillers &amp; Irrigation Pump Installers</a>	Well Driller	\$14.49		1	<a href="#">View</a>





BACK OF COVER  
THIS PAGE INTENTIONALLY LEFT BLANK



## KITSAP COUNTY DEPARTMENT OF COMMUNITY DEVELOPMENT

*To enable the development of quality, affordable, structurally safe and environmentally sound communities.*

**JEFF RIMACK**  
DIRECTOR

January 4, 2022

APPLICANT REPRESENTATIVE: BARBARA ZAROFF  
KITSAP COUNTY PUBLIC WORKS, SEWE UTILITY DIVISION  
917 DIVISION STREET M/S 26  
PORT ORCHARD, WA 98366

RE: Shoreline Permit and SEPA Exemption – Normal Maintenance and Repair  
PROJECT: Bangor-Keyport Force Main Replacement Project  
PROJECT LOCATION: The Project will replace approximately 5 miles of sewer force main beginning at Pump Station 17 near Bangor Naval Base on Clear Creek Road NW and ending on Brownsville Highway north of NE Ohara Hills Drive, Poulsbo, WA.

PERMITS: Shoreline Exemption

### PROJECT DESCRIPTION:

The proposed project design includes the replacement of approximately 5 miles of sewer force main and appurtenances. Work is confined to WSDOT and County right-of-way and an easement with BPA and private property owners. This design includes the replacement of up to 5 miles of 24-inch to 30-inch diameter HDPE DR 11 sewer force main to match existing inside diameter of 18-inch to 24-inch diameter ductile iron sewer force main (UV Cured in Place Pipe trenchless rehabilitation methods will be used for the sewer force main crossing under State Route 3).

The project will provide a permanent trench patch for sewer force main replacement within paved right-of-way, general restoration for sewer force main replacement in vegetated areas and installation of approximately 12 air vacuum valve assemblies and 7 blow off assemblies. Also included are improvements at Pump Station 17 including flow meter vault installation and temporary bypass pumping, improvements at Pump Station 24 including wet well coating and installation of underground structures for temporary bypass pumping. This also includes connections to seven existing Individual Pump Stations (IPS) and connections to existing Pump Station 67 18-inch ductile iron sewer force main.

2011 Governor's  
Smart Communities  
Award Kitsap  
County  
'Year of the Rural'



We have reviewed the request for exemption from shoreline substantial development for the above referenced project. The proposal to repair and replace the existing sewer main, lift station elements and associated sewer connections within the sewage main easement areas and within existing Rights of Way area has been determined to be exempt from a Shoreline Substantial Development Permit pursuant to KCC 22.500.100 (C) (3) b.

Approval of your exemption is subject to the following conditions:

1. A Hydraulic Project Approval Permit through the Washington State Department of Fish and Wildlife may be required prior to construction.

In accordance with Kitsap County Code Section 22.500 (C) (3) (b), an exemption from the substantial development permit process is not an exemption from compliance with the Kitsap

County Shoreline Management Master Program or from any other regulatory requirements. The shoreline program requires that you post a notice of exemption.

This project has been determined to be exempt under SEPA, pursuant to WAC 197-11-800 (3), (Repair, Remodeling and Maintenance Activities).

Should you have any questions, please do not hesitate to contact Steve Heacock, Senior Environmental Planner, at (360) 337-5777.

Sincerely,

A handwritten signature in cursive script, appearing to read "Steve Heacock", enclosed within a thin black rectangular border.

Steve Heacock  
Development Services and Engineering Division

cc:

Alison O'Sullivan, Suquamish Tribe  
Kathlene Barnhart, Suquamish Tribe  
Roma Call, Port Gamble S'Klallam Tribe  
Sam Phillips, Port Gamble S'Klallam Tribe  
Point No Point Treaty Council: Cynthia Rossi  
WDFW, Nam Sui  
DOE Shoreline, Maria Sandercock



## KITSAP COUNTY DEPARTMENT OF COMMUNITY DEVELOPMENT

619 DIVISION STREET MS-36, PORT ORCHARD WASHINGTON 98366-4682  
(360) 337-5777 HOME PAGE - [www.kitsapgov.com/dcd/](http://www.kitsapgov.com/dcd/)

JEFF RIMACK, Director

### DETERMINATION OF SEPA EXEMPTION

**Kitsap County Public Works Sewer Utility Division, Bangor-Keyport Force Main Replacement Project.** The proposed project design includes the replacement of approximately 5 miles of sewer force main and appurtenances. Work is confined to WSDOT and County right-of-way and an easement with BPA and private property owners. This design includes the replacement of up to 5 miles of 24-inch to 30-inch diameter HDPE DR 11 sewer force main to match existing inside diameter of 18-inch to 24-inch diameter ductile iron sewer force main (UV Cured in Place Pipe trenchless rehabilitation methods will be used for the sewer force main crossing under State Route 3).

The project will provide a permanent trench patch for sewer force main replacement within paved right-of-way, general restoration for sewer force main replacement in vegetated areas and installation of approximately 12 air vacuum valve assemblies and 7 blow off assemblies.

Also included are improvements at Pump Station 17 including flow meter vault installation and temporary bypass pumping, improvements at Pump Station 24 including wet well coating and installation of underground structures for temporary bypass pumping. This also includes connections to seven existing Individual Pump Stations (IPS) and connections to existing Pump Station 67 18-inch ductile iron sewer force main.

Proponent: Kitsap County Public Works, Sewer Utility Division

Lead Agency: Kitsap County

Location of proposal: The Project will replace approximately 5 miles of sewer force main beginning at Pump Station 17 near Bangor Naval Base on Clear Creek Road NW and ending on Brownsville Highway north of NE Ohara Hills Drive, Poulsbo, WA.

We have reviewed the plans for the proposed project for SEPA requirements, as referenced above. The proposal to repair and replace the existing force main lines, connections, associated pump stations, repair and replace infrastructure, pumps and paved surfaces has been determined to be exempt from SEPA in accordance with *WAC 197-11-800(3) Repair, Remodeling and Maintenance Activities*. Work is proposed to commence in the summer of 2022.

Should you have any questions regarding this project, please contact Steve Heacock, SEPA Coordinator, via e-mail at [sheacock@co.kitsap.wa.us](mailto:sheacock@co.kitsap.wa.us)

Responsible Official: Scott Diener Contact: Steve Heacock  
Position/Title: SEPA Coordinator, Dept. of Community Development Phone: (360)337-5777  
Address: 614 Division Street, Port Orchard, WA 98366

DATE: December 17, 2021

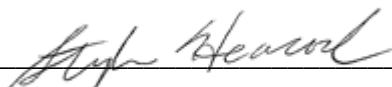
Signature: 



BACK OF COVER  
THIS PAGE INTENTIONALLY LEFT BLANK

\\ad.msa-ep.com\Everett\evt\_projects\20\2815 - Kitsap County Bangor\_fm Replacement\CAD\Sheets\20-2815-WA-SEQ.dwg 1 of 4 1/7/2022 5:34 PM NICK.MCFADDIN 23.05 (LMS Tech)

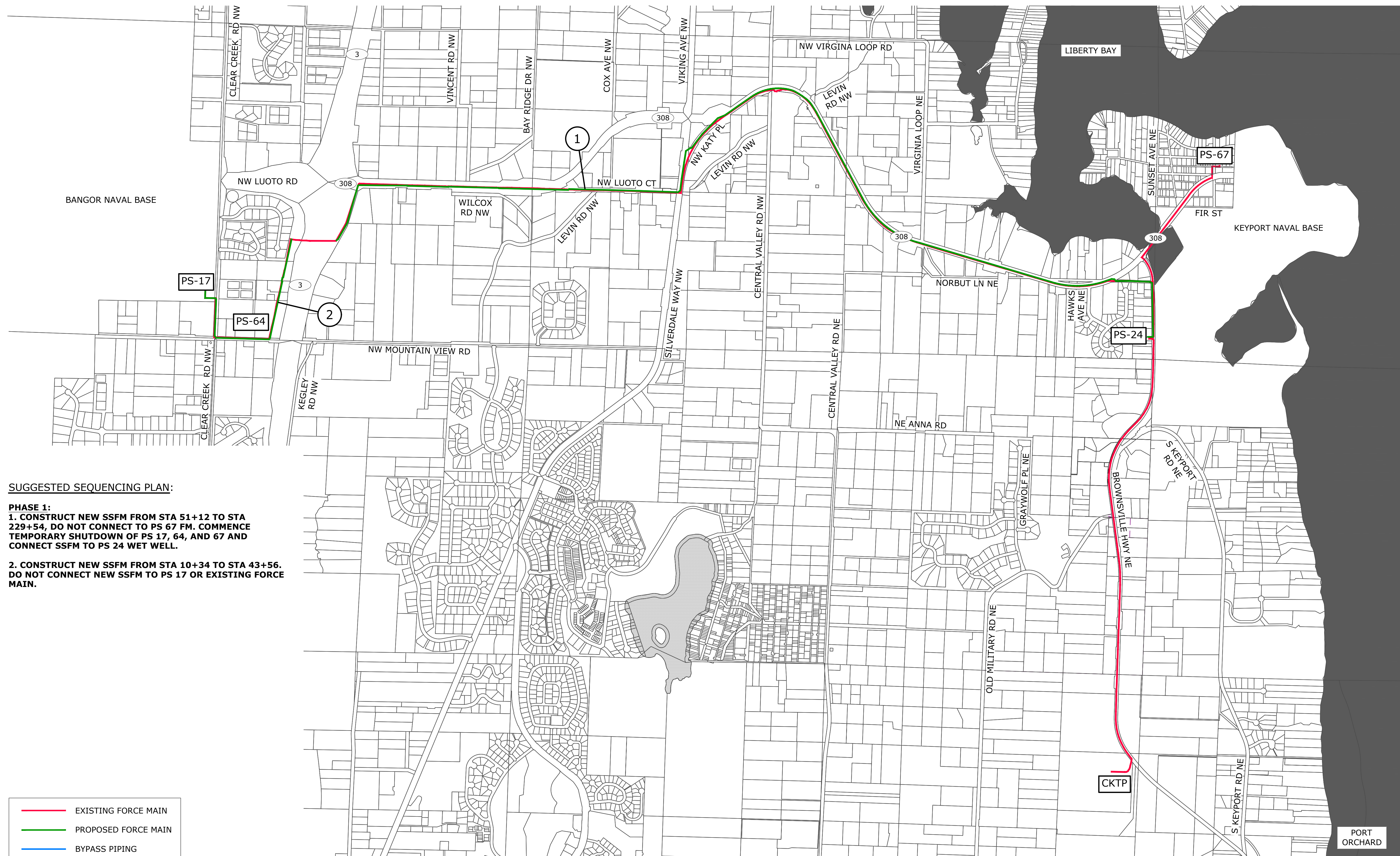

**SUGGESTED SEQUENCING PLAN:**

- PHASE 1:**
1. CONSTRUCT NEW SSFM FROM STA 51+12 TO STA 229+54, DO NOT CONNECT TO PS 67 FM. COMMENCE TEMPORARY SHUTDOWN OF PS 17, 64, AND 67 AND CONNECT SSFM TO PS 24 WET WELL.
  2. CONSTRUCT NEW SSFM FROM STA 10+34 TO STA 43+56. DO NOT CONNECT NEW SSFM TO PS 17 OR EXISTING FORCE MAIN.

	EXISTING FORCE MAIN
	PROPOSED FORCE MAIN
	BYPASS PIPING

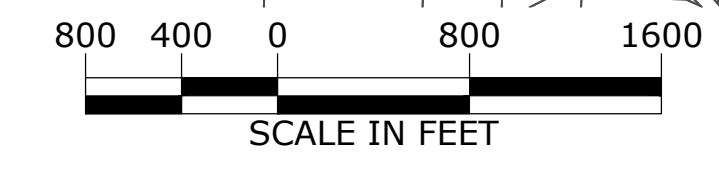

**100% SUBMITTAL**

NO.	DATE	BY	REVISION

NOTICE  
  
 IF THIS BAR DOES NOT MEASURE 1" THEN DRAWING IS NOT TO SCALE

TMH DESIGNED  
 MNF DRAWN  
 EKS CHECKED

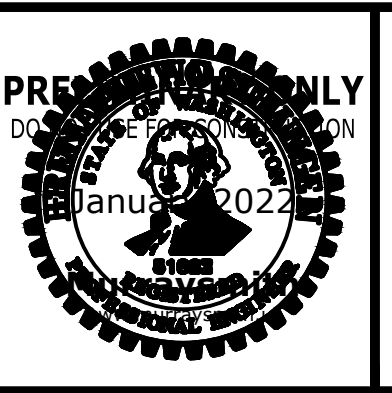

**BANGOR-KEYPORT  
 FORCE MAIN  
 REPLACEMENT**

**APPENDIX E  
 SUGGESTED SEQUENCING  
 PLAN - PHASE 1 -  
 REFERENCE ONLY**

PROJECT NO.: 20-2815 SCALE: AS SHOWN DATE: DECEMBER 2021

SHEET  
**1 OF 4**



\\ad.msa-ep.com\everett\vt\_projects\20\2815 - Kitsap County Bangor\_keyport\_fm Replacement\CAD\Sheets\20-2815-WA-SEQ.dwg 2 of 4 1/7/2022 5:34 PM NICK.MCFADDIN 23.05 (LMS Tech)

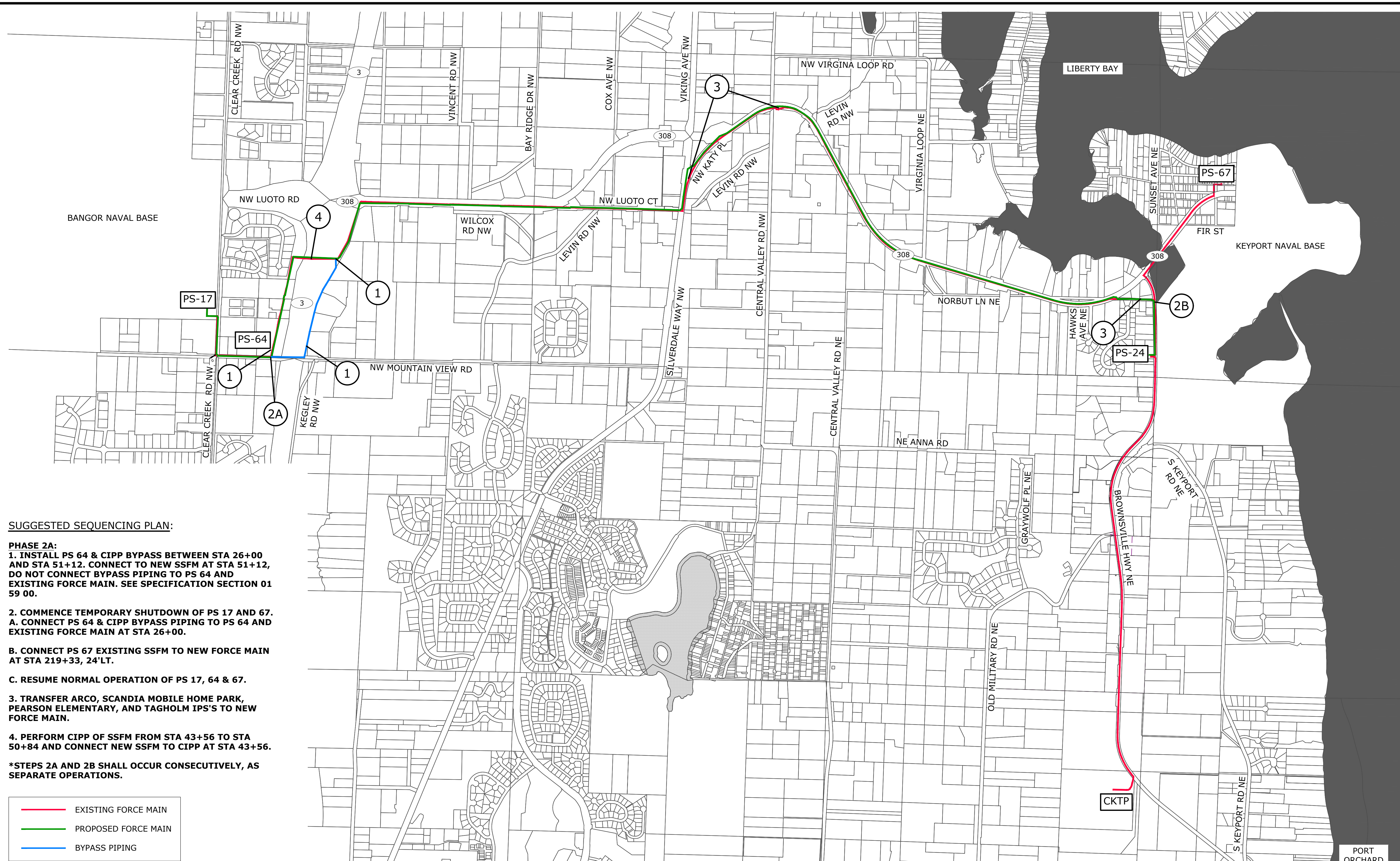

**SUGGESTED SEQUENCING PLAN:**

- PHASE 2A:**
- 1. INSTALL PS 64 & CIPP BYPASS BETWEEN STA 26+00 AND STA 51+12. CONNECT TO NEW SSFM AT STA 51+12, DO NOT CONNECT BYPASS PIPING TO PS 64 AND EXISTING FORCE MAIN. SEE SPECIFICATION SECTION 01 59 00.**
  - 2. COMMENCE TEMPORARY SHUTDOWN OF PS 17 AND 67.**
    - A. CONNECT PS 64 & CIPP BYPASS PIPING TO PS 64 AND EXISTING FORCE MAIN AT STA 26+00.**
    - B. CONNECT PS 67 EXISTING SSFM TO NEW FORCE MAIN AT STA 219+33, 24'LT.**
    - C. RESUME NORMAL OPERATION OF PS 17, 64 & 67.**
  - 3. TRANSFER ARCO, SCANDIA MOBILE HOME PARK, PEARSON ELEMENTARY, AND TAGHOLM IPS'S TO NEW FORCE MAIN.**
  - 4. PERFORM CIPP OF SSFM FROM STA 43+56 TO STA 50+84 AND CONNECT NEW SSFM TO CIPP AT STA 43+56.**
- \*STEPS 2A AND 2B SHALL OCCUR CONSECUTIVELY, AS SEPARATE OPERATIONS.**

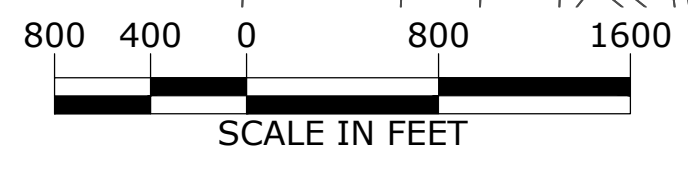
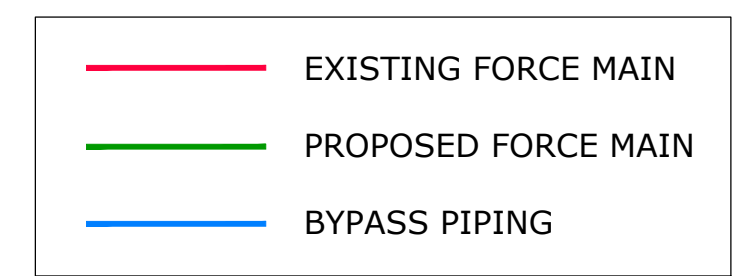

**100% SUBMITTAL**

NO.	DATE	BY	REVISION

NOTICE  
0 1/2 1  
IF THIS BAR DOES NOT MEASURE 1" THEN DRAWING IS NOT TO SCALE

TMH DESIGNED  
MNF DRAWN  
EKS CHECKED

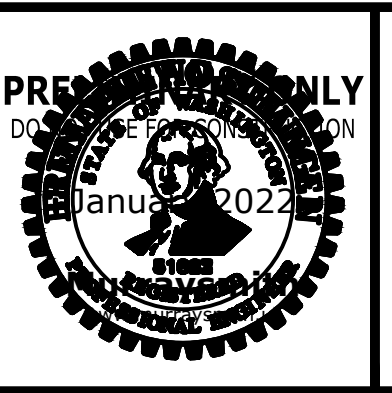

**BANGOR-KEYPORT FORCE MAIN REPLACEMENT**

**APPENDIX E  
SUGGESTED SEQUENCING PLAN - PHASE 2A - REFERENCE ONLY**

PROJECT NO.: 20-2815 SCALE: AS SHOWN DATE: DECEMBER 2021

SHEET  
**2 OF 4**

\\ad.msa-ep.com\everett\vt\_projects\20\2815 - Kitsap County Bangor\_keyport\_fm Replacement\CAD\Sheets\20-2815-WA-SEQ.dwg 3 of 4 1/7/2022 5:34 PM NICK.MCFADDIN 23.05 (LMS Tech)

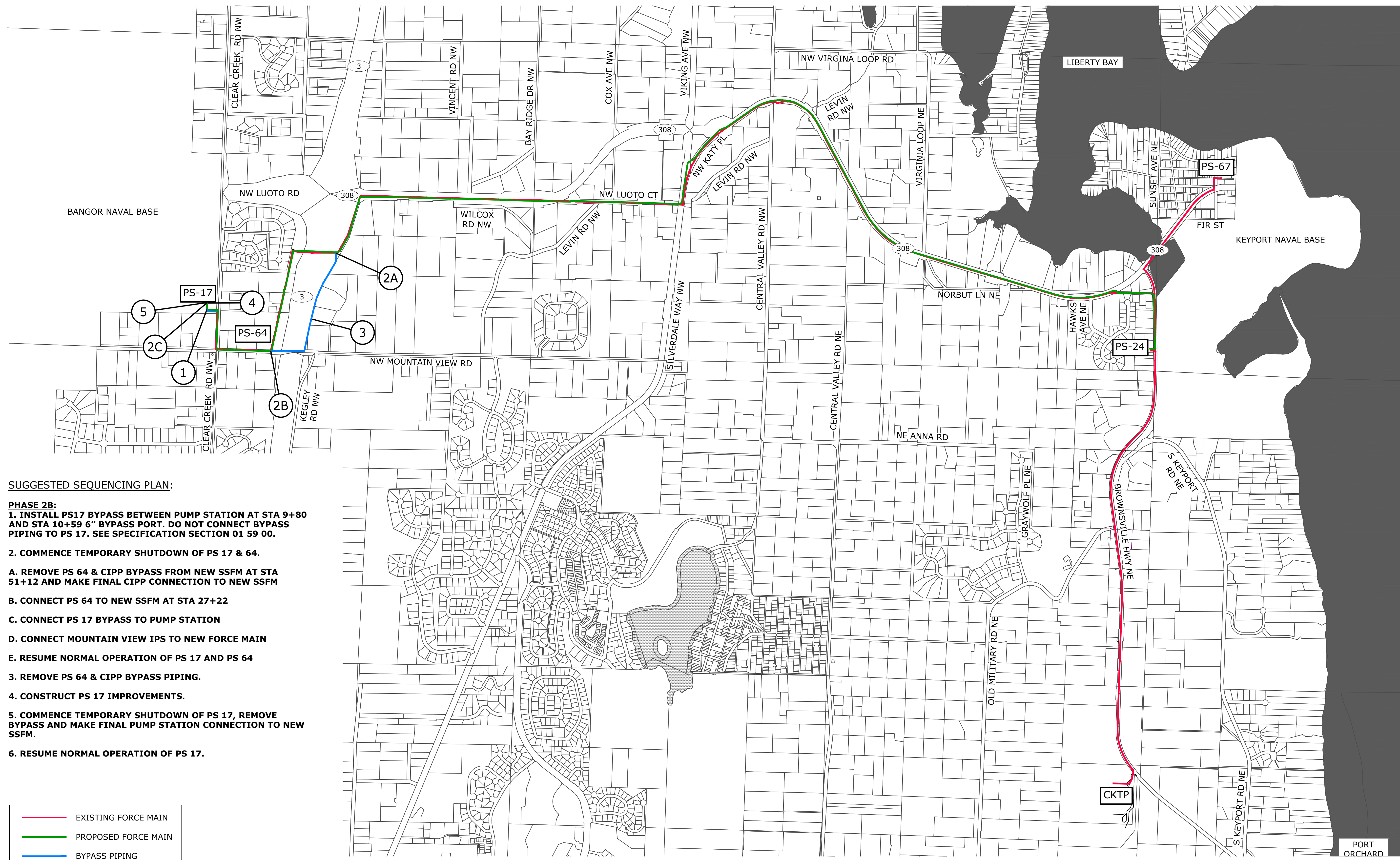

**SUGGESTED SEQUENCING PLAN:**

**PHASE 2B:**

1. INSTALL PS17 BYPASS BETWEEN PUMP STATION AT STA 9+80 AND STA 10+59 6" BYPASS PORT. DO NOT CONNECT BYPASS PIPING TO PS 17. SEE SPECIFICATION SECTION 01 59 00.
2. COMMENCE TEMPORARY SHUTDOWN OF PS 17 & 64.
  - A. REMOVE PS 64 & CIPP BYPASS FROM NEW SSFM AT STA 51+12 AND MAKE FINAL CIPP CONNECTION TO NEW SSFM
  - B. CONNECT PS 64 TO NEW SSFM AT STA 27+22
  - C. CONNECT PS 17 BYPASS TO PUMP STATION
  - D. CONNECT MOUNTAIN VIEW IPS TO NEW FORCE MAIN
  - E. RESUME NORMAL OPERATION OF PS 17 AND PS 64
3. REMOVE PS 64 & CIPP BYPASS PIPING.
4. CONSTRUCT PS 17 IMPROVEMENTS.
5. COMMENCE TEMPORARY SHUTDOWN OF PS 17, REMOVE BYPASS AND MAKE FINAL PUMP STATION CONNECTION TO NEW SSFM.
6. RESUME NORMAL OPERATION OF PS 17.

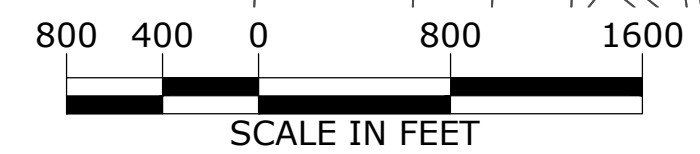
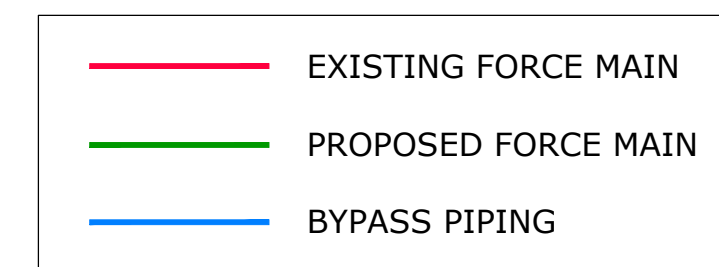

**100% SUBMITTAL**

NO.	DATE	BY	REVISION

NOTICE  
0 1/2 1  
IF THIS BAR DOES NOT MEASURE 1" THEN DRAWING IS NOT TO SCALE

TMH DESIGNED  
MNF DRAWN  
EKS CHECKED



**murraysmith**

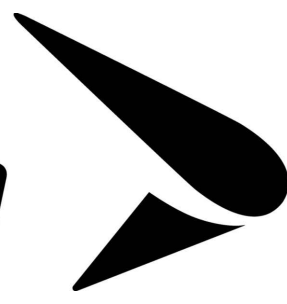

**BANGOR-KEYPORT FORCE MAIN REPLACEMENT**

**APPENDIX E  
SUGGESTED SEQUENCING PLAN - PHASE 2B -  
REFERENCE ONLY**

PROJECT NO.: 20-2815 SCALE: AS SHOWN DATE: DECEMBER 2021

SHEET  
**3 OF 4**

\\ad.msa-ep.com\everett\evt\_projects\20\2815 - Kitsap County Bangor\_keyport\_fm Replacement\CAD\Sheets\20-2815-WA-SEQ.dwg 4 of 4 1/7/2022 5:34 PM NICK.MCFADDIN 23.05 (LMS Tech)

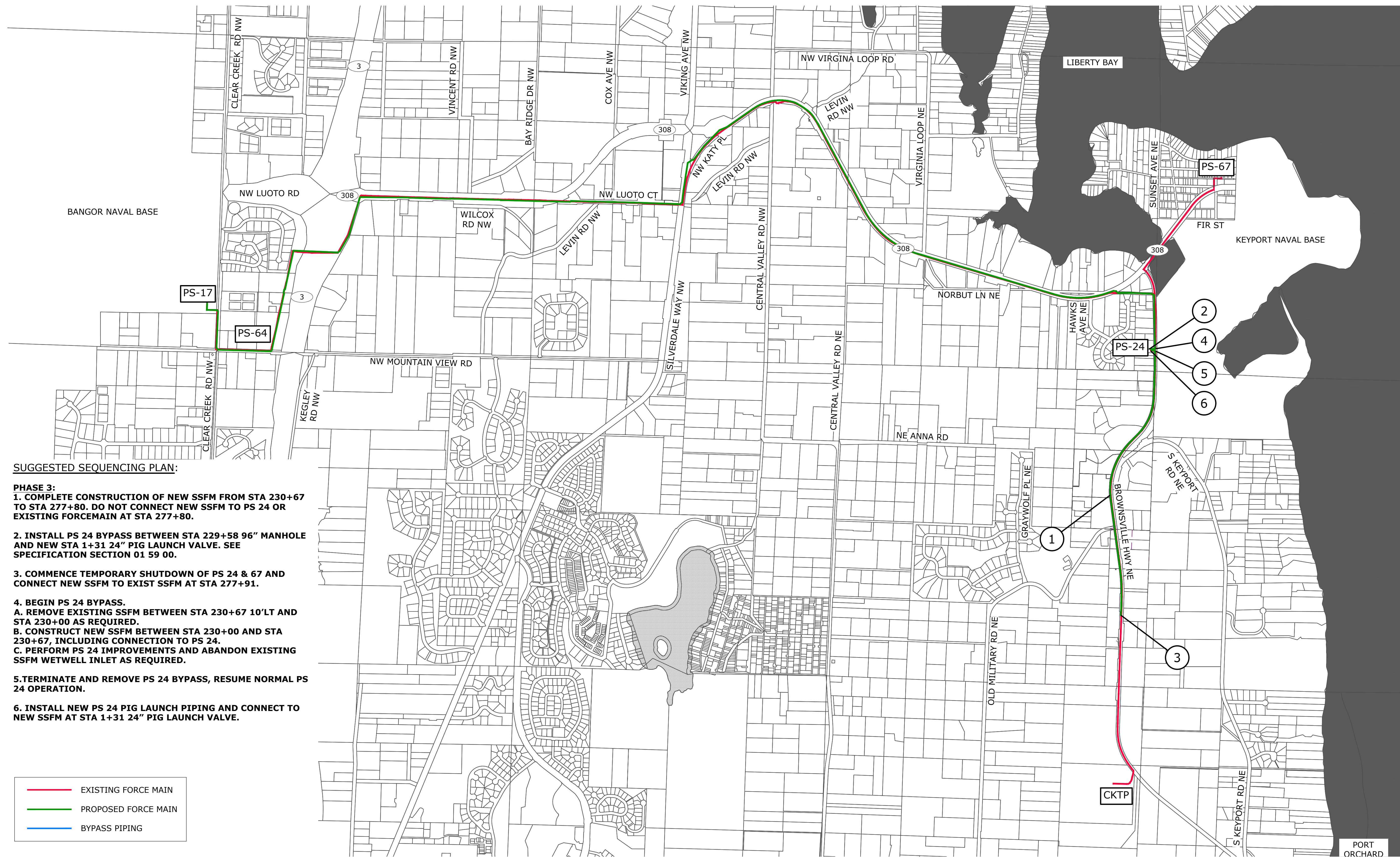

**SUGGESTED SEQUENCING PLAN:**

- PHASE 3:**
1. COMPLETE CONSTRUCTION OF NEW SSFM FROM STA 230+67 TO STA 277+80. DO NOT CONNECT NEW SSFM TO PS 24 OR EXISTING FORCEMAIN AT STA 277+80.
  2. INSTALL PS 24 BYPASS BETWEEN STA 229+58 96" MANHOLE AND NEW STA 1+31 24" PIG LAUNCH VALVE. SEE SPECIFICATION SECTION 01 59 00.
  3. COMMENCE TEMPORARY SHUTDOWN OF PS 24 & 67 AND CONNECT NEW SSFM TO EXIST SSFM AT STA 277+91.
  4. BEGIN PS 24 BYPASS.
    - A. REMOVE EXISTING SSFM BETWEEN STA 230+67 10'LT AND STA 230+00 AS REQUIRED.
    - B. CONSTRUCT NEW SSFM BETWEEN STA 230+00 AND STA 230+67, INCLUDING CONNECTION TO PS 24.
    - C. PERFORM PS 24 IMPROVEMENTS AND ABANDON EXISTING SSFM WETWELL INLET AS REQUIRED.
  5. TERMINATE AND REMOVE PS 24 BYPASS, RESUME NORMAL PS 24 OPERATION.
  6. INSTALL NEW PS 24 PIG LAUNCH PIPING AND CONNECT TO NEW SSFM AT STA 1+31 24" PIG LAUNCH VALVE.

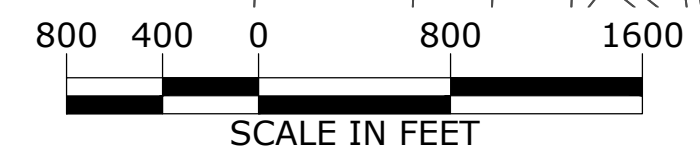
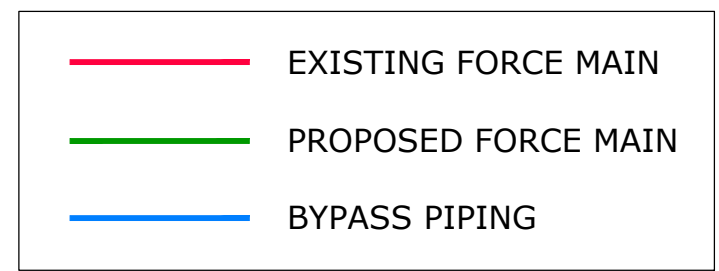

**100% SUBMITTAL**

NO.	DATE	BY	REVISION

NOTICE  
 0 1/2 1  
 IF THIS BAR DOES NOT MEASURE 1" THEN DRAWING IS NOT TO SCALE

TMH DESIGNED  
 MNF DRAWN  
 EKS CHECKED

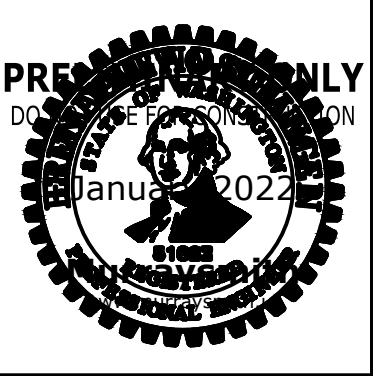

**BANGOR-KEYPORT FORCE MAIN REPLACEMENT**

**APPENDIX E  
 SUGGESTED SEQUENCING PLAN - PHASE 3 - REFERENCE ONLY**

PROJECT NO.: 20-2815 SCALE: AS SHOWN DATE: DECEMBER 2021

SHEET  
**4 OF 4**



BACK OF COVER  
THIS PAGE INTENTIONALLY LEFT BLANK

\\ad.msa-ep.com\everett\evt\_projects\20\2815 - Kitsap County Bangor\_keyport\_fm\_replacement\CAD\Sheets\20-2815-WA-APPDX B-2.dwg 1 of 3 1/7/2022 5:03 PM NICK.MCFADDIN 23.0s (LWS Tech)

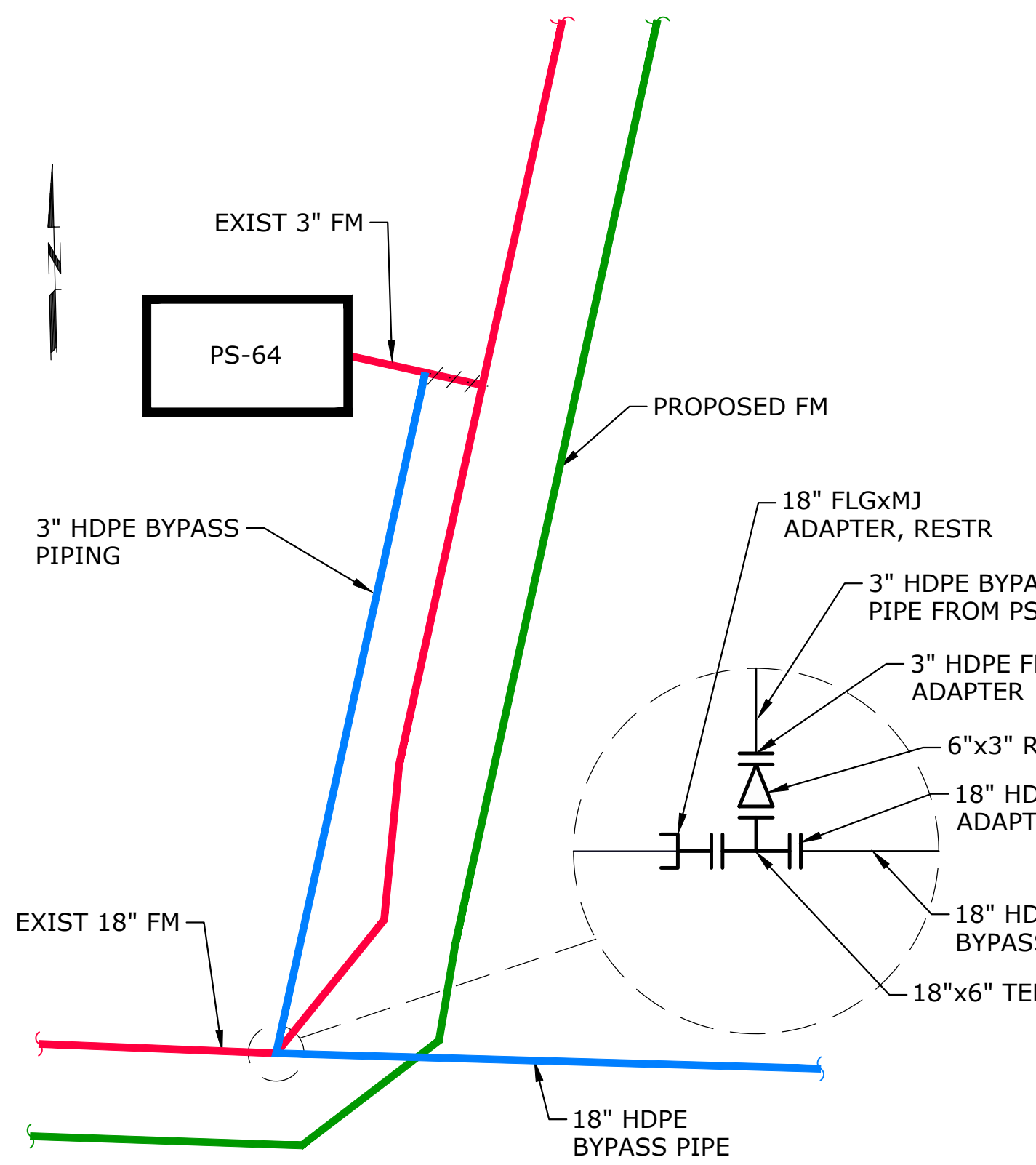

**PS 64 TEMP BYPASS CONNECTION**

SCALE: NTS

1

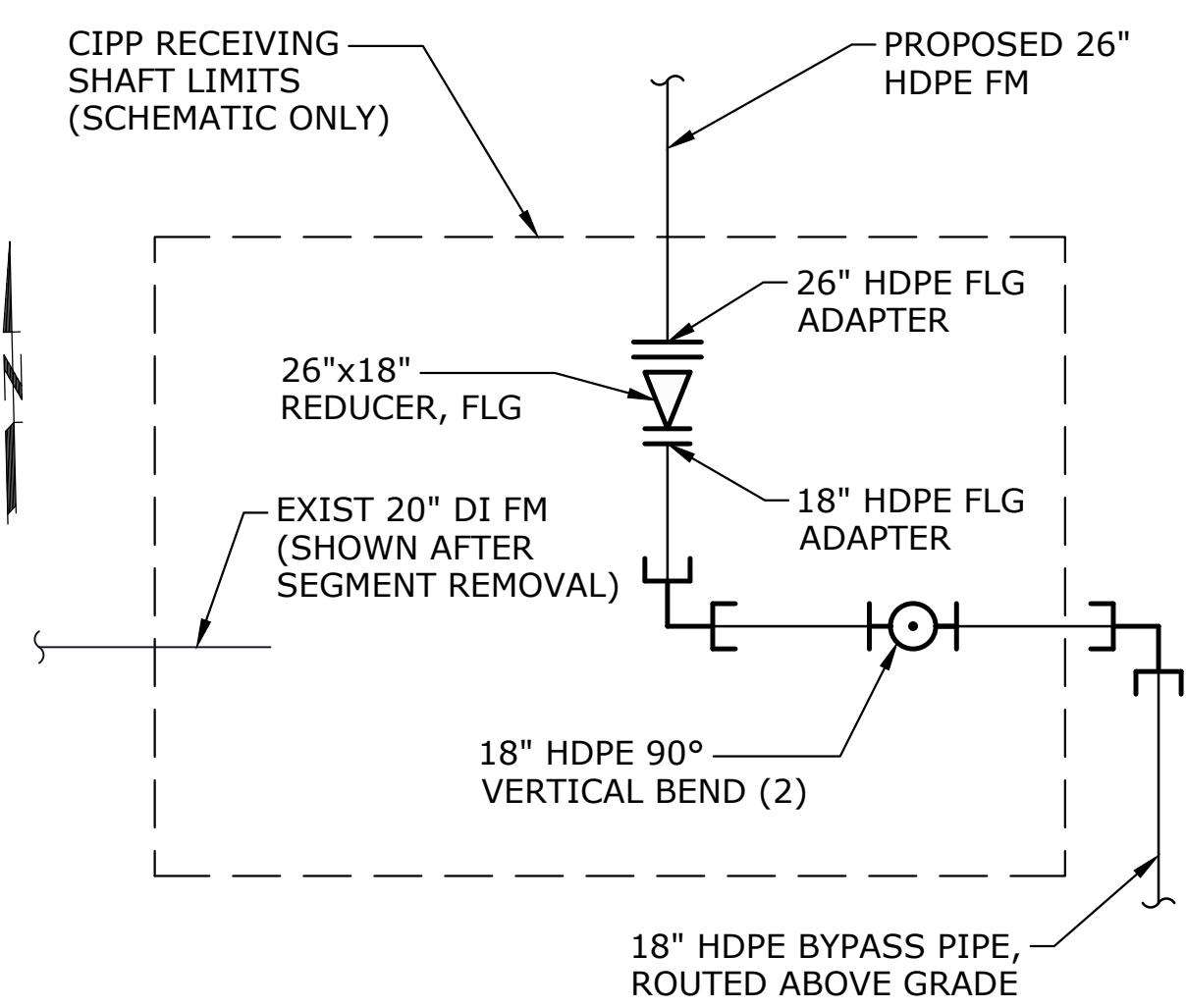

**CIPP RECEIVING SHAFT TEMP BYPASS CONNECTION**

SCALE: NTS

2

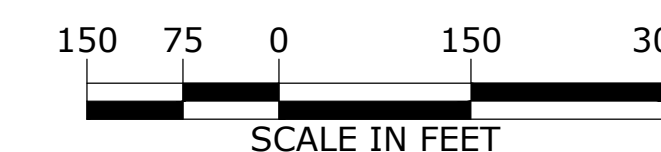
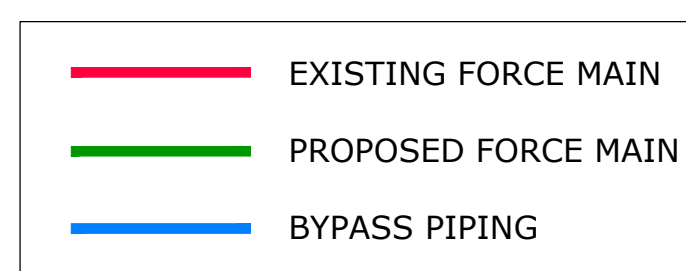
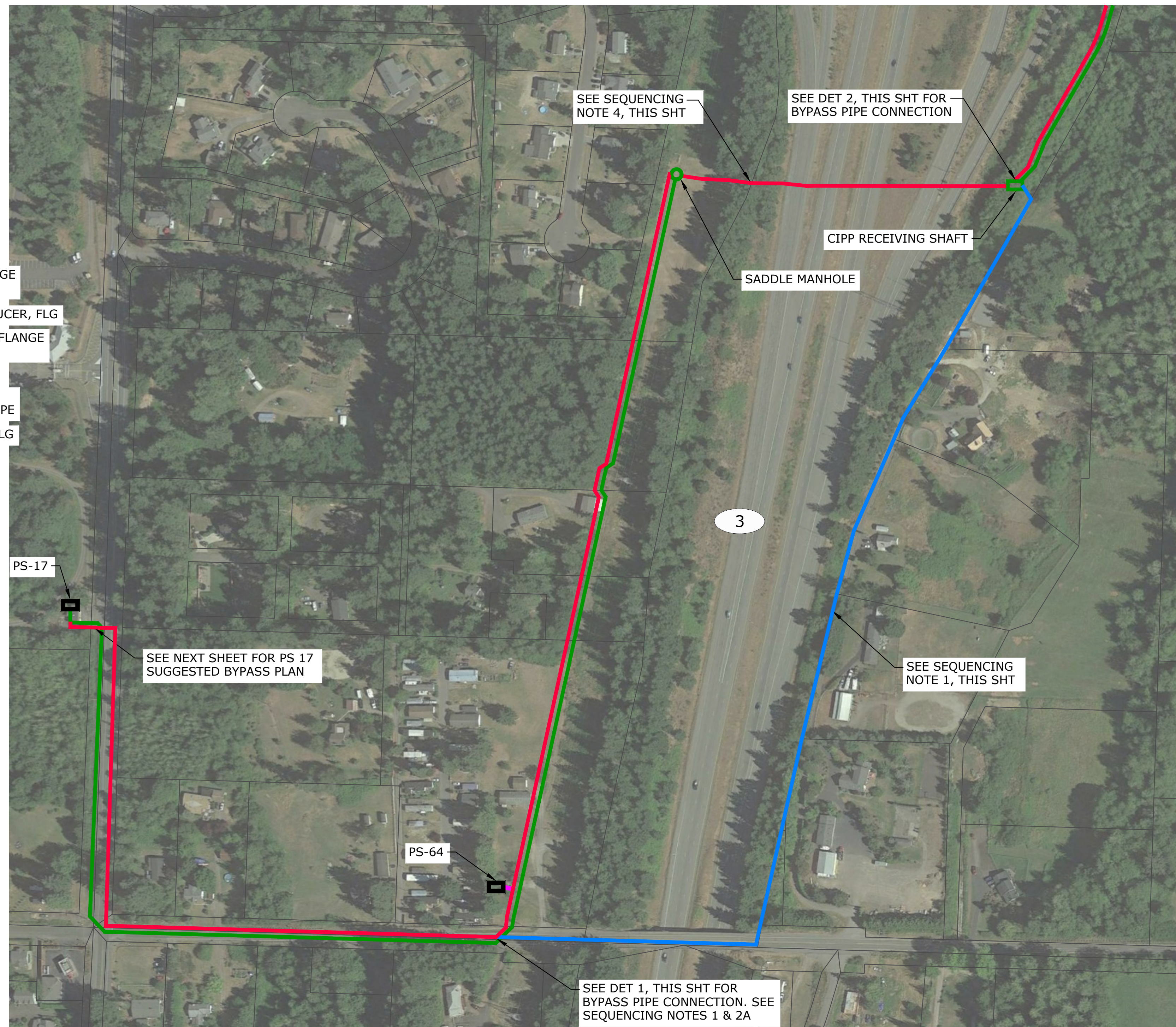

**SUGGESTED SEQUENCING (SEE APPENDIX A FOR FULL PROJECT CONSTRUCTION SEQUENCE):**

**PHASE 2A:**

1. INSTALL PS 64 & CIPP BYPASS BETWEEN STA 26+00 AND STA 51+12. CONNECT TO NEW SSFM AT STA 51+12, DO NOT CONNECT BYPASS PIPING TO PS 64 AND EXISTING FORCE MAIN. SEE SPECIFICATION SECTION 01 59 00.

2. COMMENCE TEMPORARY SHUTDOWN OF PS 17 AND 67.  
A. CONNECT PS 64 & CIPP BYPASS PIPING TO PS 64 AND EXISTING FORCE MAIN AT STA 26+00.

B. CONNECT PS 67 EXISTING SSFM TO NEW FORCE MAIN AT STA 219+33, 24'LT.

C. RESUME NORMAL OPERATION OF PS 17, 64 & 67.

3. TRANSFER ARCO, SCANDIA MOBILE HOME PARK, PEARSON ELEMENTARY, AND TAGHOLM IPS'S TO NEW FORCE MAIN.

4. PERFORM CIPP OF SSFM FROM STA 43+56 TO STA 50+84 AND CONNECT NEW SSFM TO CIPP AT STA 43+56.

\*STEPS 2A AND 2B SHALL OCCUR CONSECUTIVELY, AS SEPARATE OPERATIONS.

**GENERAL NOTES:**

1. SUGGESTED BYPASS TO UTILIZE EXIST PS 17 & 64 PUMPS TO CONVEY FLOWS DURING BYPASS.

2. TEMPORARY SHUT DOWNS OF PS 17 AND PS 64 ARE REQUIRED FOR DRAINAGE OF EXIST FORCE MAIN AND CONNECTIONS TO TEMPORARY BYPASS PIPING AND PROPOSED FORCE MAIN; TEMPORARY SHUT DOWNS SHALL BE PERFORMED DURING LOW FLOW PERIODS AND UTILIZE TANKER TRUCKS TO TRANSPORT FLOWS.

**100% SUBMITTAL**

NO.	DATE	BY	REVISION

NOTICE

0 1/2 1

IF THIS BAR DOES NOT MEASURE 1" THEN DRAWING IS NOT TO SCALE

TMH  
DESIGNED  
MNF  
DRAWN  
EKS  
CHECKED



**murraysmith**



**BANGOR-KEYPORT  
FORCE MAIN  
REPLACEMENT**

**APPENDIX F  
CIPP SUGGESTED BYPASS PLAN  
- REFERENCE ONLY**

PROJECT NO.: 20-2815 SCALE: AS SHOWN DATE: DECEMBER 2021

SHEET  
**1 OF 3**

\\ad.msa-ep.com\everett\evt\_projects\20\2815 - Kitsap County Bangor\_keyport Fm Replacement\CAD\Sheets\20-2815-WA-APPDX B-1.dwg 2 of 3 1/7/2022 5:31 PM NICK.MCFADDIN 23.0s (LMS Tech)

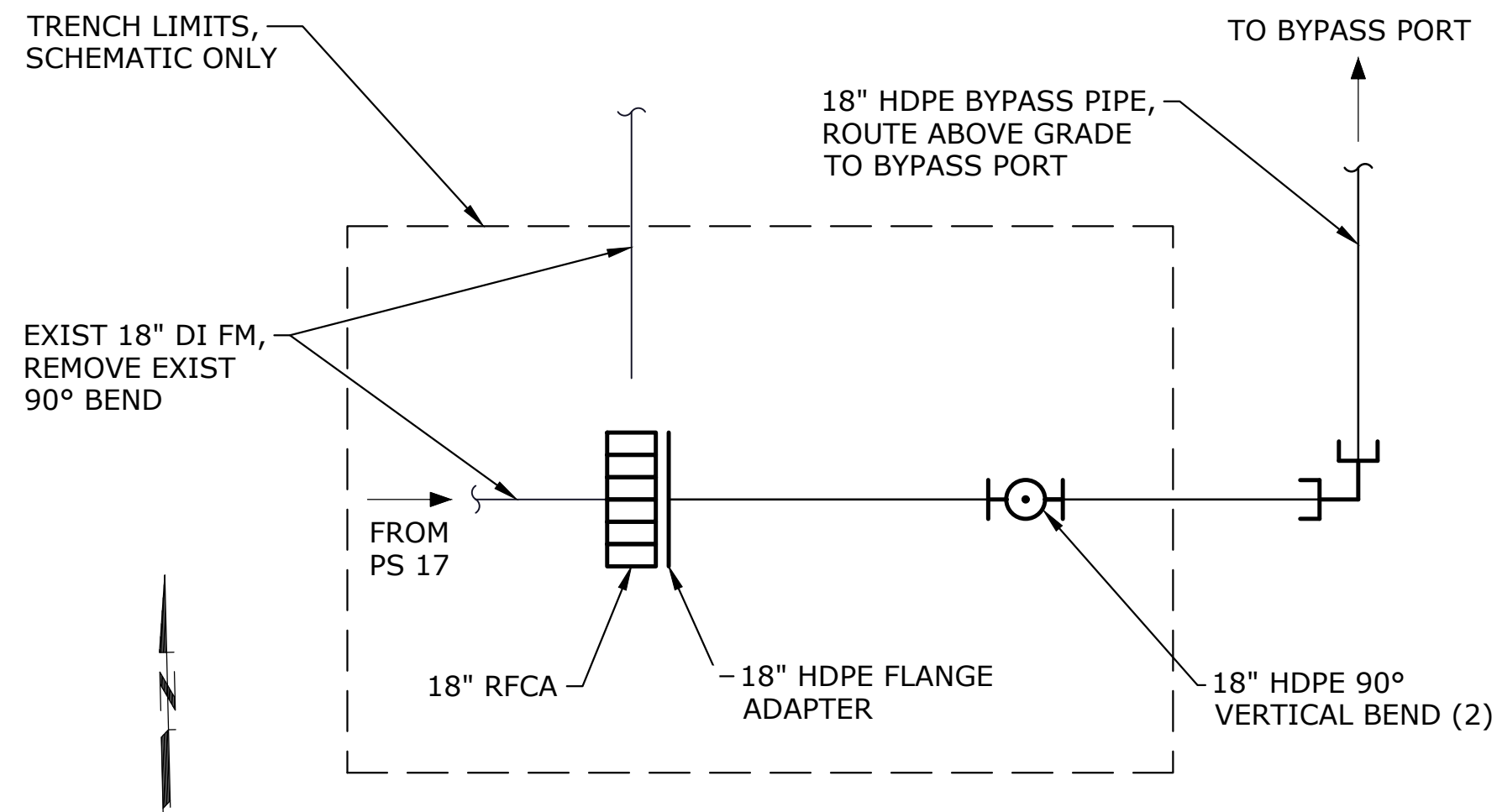

**EXIST FM BYPASS CONNECTION**

SCALE: NTS

1

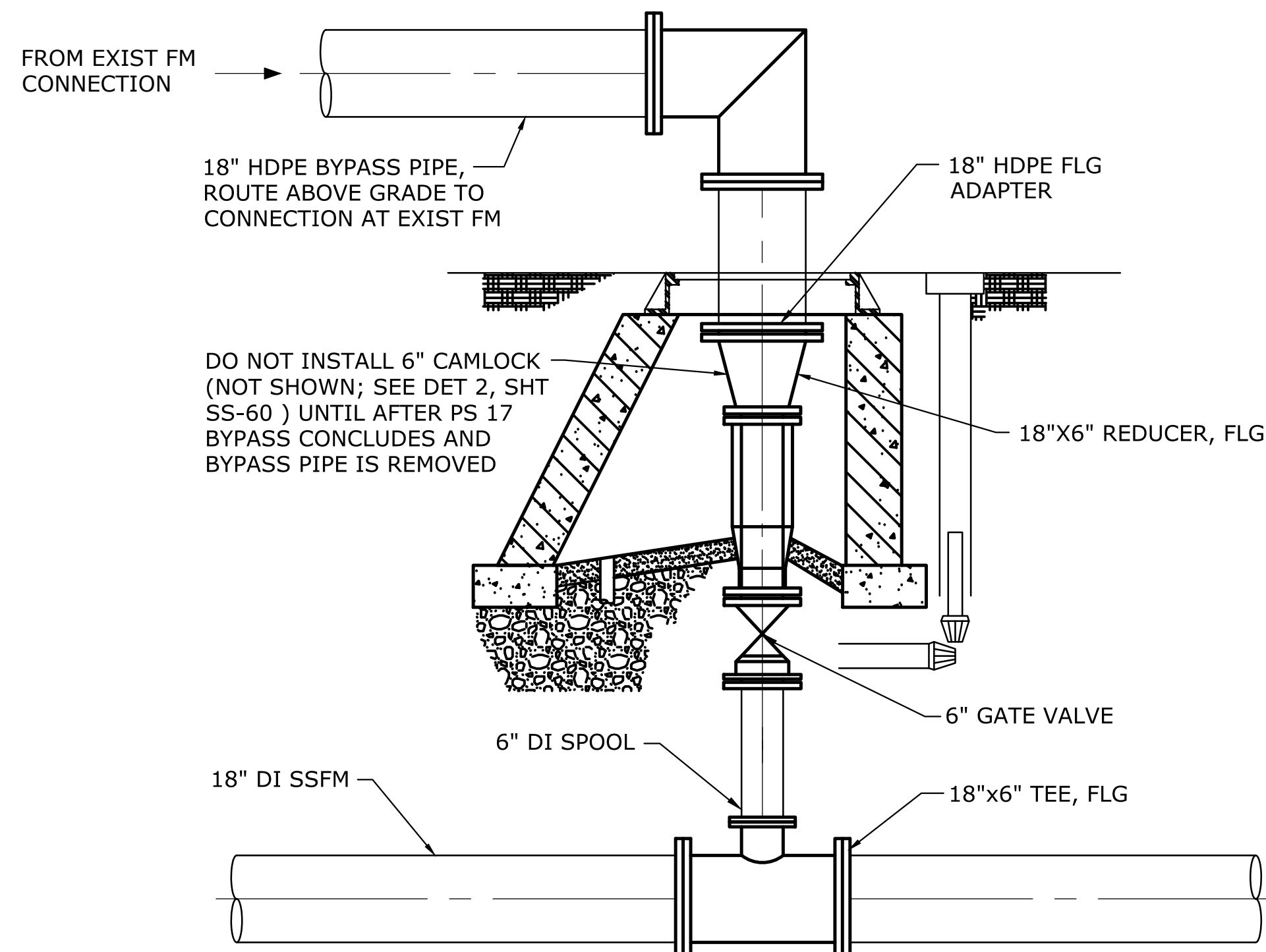

**BYPASS PORT CONNECTION**

SCALE: NTS

2

SUGGESTED SEQUENCING (SEE APPENDIX A FOR FULL PROJECT CONSTRUCTION SEQUENCE):

- PHASE 2B:**
1. INSTALL PS17 BYPASS BETWEEN PUMP STATION AT STA 9+80 AND STA 10+59 6" BYPASS PORT. DO NOT CONNECT BYPASS PIPING TO PS 17. SEE SPECIFICATION SECTION 01 59 00.
  2. COMMENCE TEMPORARY SHUTDOWN OF PS 17 & 64.
    - A. REMOVE PS 64 & CIPP BYPASS FROM NEW SSFM AT STA 51+12 AND MAKE FINAL CIPP CONNECTION TO NEW SSFM
    - B. CONNECT PS 64 TO NEW SSFM AT STA 27+22
    - C. CONNECT PS 17 BYPASS TO PUMP STATION
    - D. CONNECT MOUNTAIN VIEW IPS TO NEW FORCE MAIN
    - E. RESUME NORMAL OPERATION OF PS 17 AND PS 64
  3. REMOVE PS 64 & CIPP BYPASS PIPING.
  4. CONSTRUCT PS 17 IMPROVEMENTS.
  5. COMMENCE TEMPORARY SHUTDOWN OF PS 17, REMOVE BYPASS AND MAKE FINAL PUMP STATION CONNECTION TO NEW SSFM.
  6. RESUME NORMAL OPERATION OF PS 17.

**GENERAL NOTES:**

1. SUGGESTED BYPASS TO UTILIZE EXIST PS 17 PUMPS TO CONVEY FLOWS DURING BYPASS
2. TEMPORARY SHUT DOWN OF PS 17 IS REQUIRED FOR DRAINAGE OF EXIST FORCE MAIN AND CONNECTIONS TO TEMPORARY BYPASS PIPING AND PROPOSED FORCE MAIN; TEMPORARY SHUT DOWNS SHALL BE PERFORMED DURING LOW FLOW PERIODS AND UTILIZE TANKER TRUCKS TO TRANSPORT FLOWS.

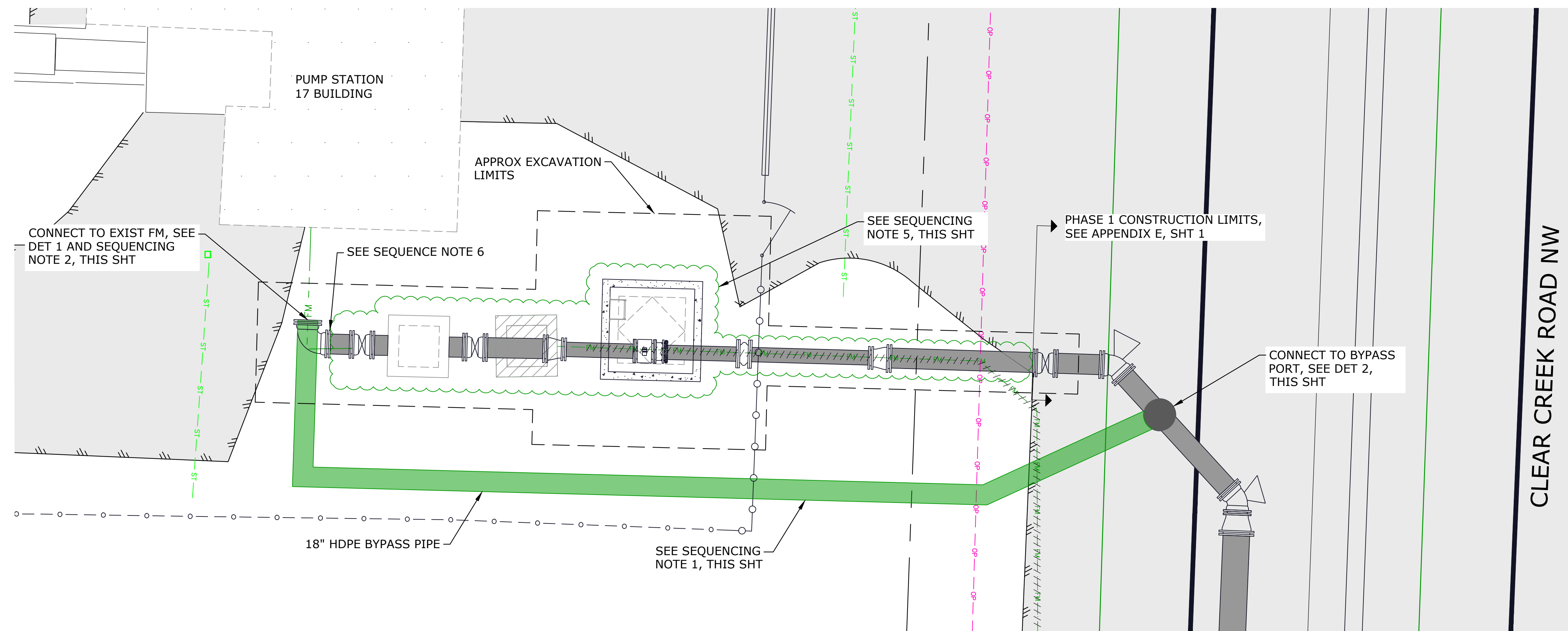

**PLAN**

SCALE: 1"=5'

**100% SUBMITTAL**

NO.	DATE	BY	REVISION

NOTICE  
 0 1/2 1  
 IF THIS BAR DOES NOT MEASURE 1" THEN DRAWING IS NOT TO SCALE

TMH  
 DESIGNED  
 MNF  
 DRAWN  
 EKS  
 CHECKED

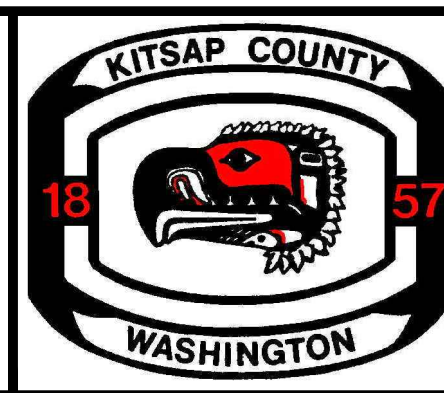
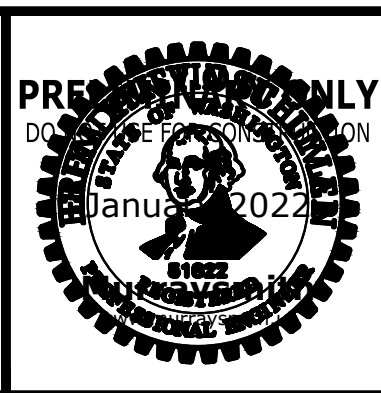

**BANGOR-KEYPORT  
 FORCE MAIN  
 REPLACEMENT**

**APPENDIX F  
 PUMP STATION 17  
 SUGGESTED BYPASS PLAN  
 - REFERENCE ONLY**

PROJECT NO.: 20-2815 SCALE: AS SHOWN DATE: DECEMBER 2021

SHEET  
**2 OF 3**

\\ad.msa-ep.com\everett\evt\_projects\20\2815 - Kitsap County Bangor Keyport Fm Replacement\CAD\Sheets\20-2815-WA-APPDX B-4.dwg 3 of 3 1/7/2022 5:16 PM NICK.MCFADDIN 23.0s (LMS Tech)

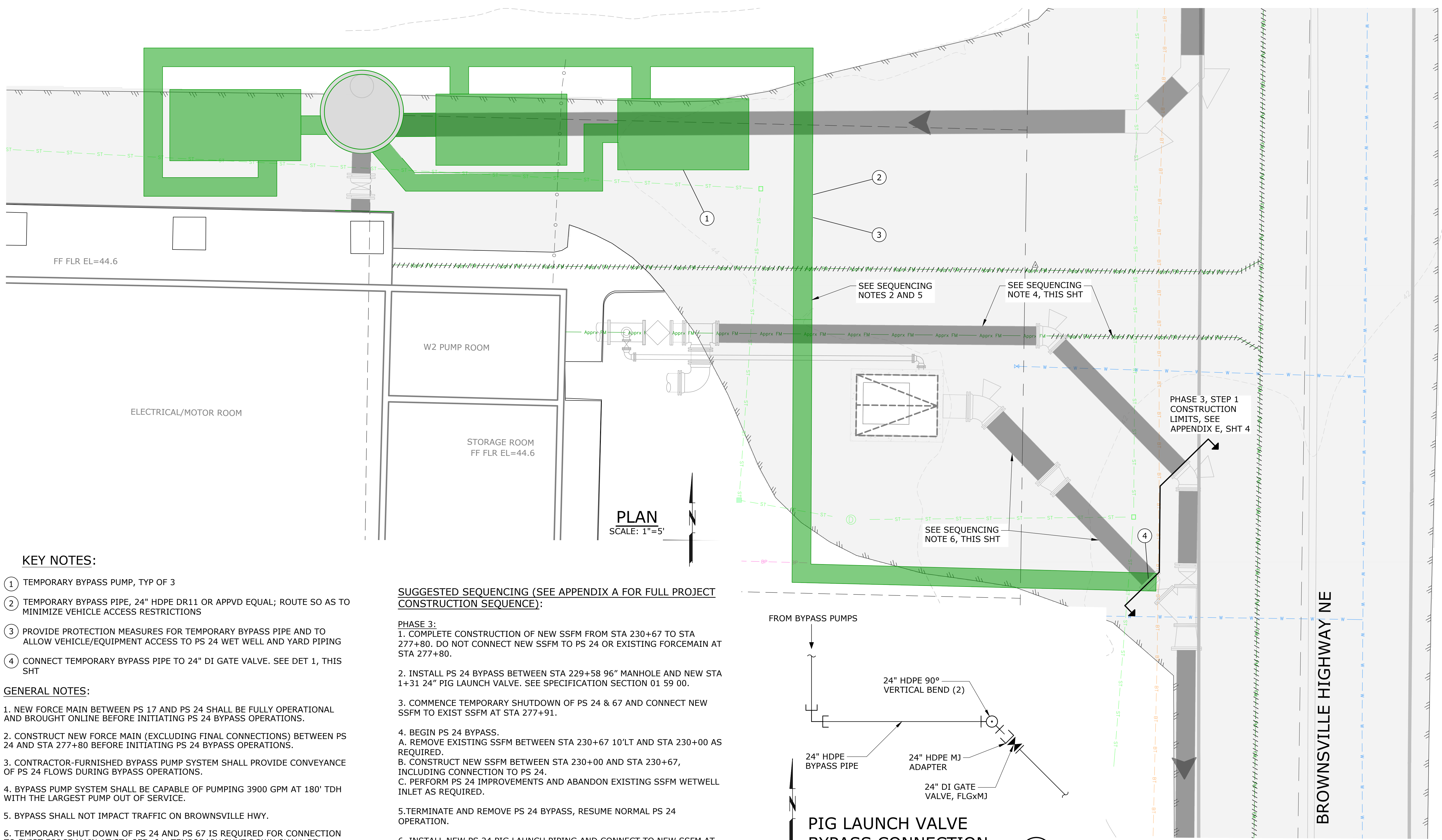

**KEY NOTES:**

- ① TEMPORARY BYPASS PUMP, TYP OF 3
- ② TEMPORARY BYPASS PIPE, 24" HDPE DR11 OR APPVD EQUAL; ROUTE SO AS TO MINIMIZE VEHICLE ACCESS RESTRICTIONS
- ③ PROVIDE PROTECTION MEASURES FOR TEMPORARY BYPASS PIPE AND TO ALLOW VEHICLE/EQUIPMENT ACCESS TO PS 24 WET WELL AND YARD PIPING
- ④ CONNECT TEMPORARY BYPASS PIPE TO 24" DI GATE VALVE. SEE DET 1, THIS SHT

**GENERAL NOTES:**

- 1. NEW FORCE MAIN BETWEEN PS 17 AND PS 24 SHALL BE FULLY OPERATIONAL AND BROUGHT ONLINE BEFORE INITIATING PS 24 BYPASS OPERATIONS.
- 2. CONSTRUCT NEW FORCE MAIN (EXCLUDING FINAL CONNECTIONS) BETWEEN PS 24 AND STA 277+80 BEFORE INITIATING PS 24 BYPASS OPERATIONS.
- 3. CONTRACTOR-FURNISHED BYPASS PUMP SYSTEM SHALL PROVIDE CONVEYANCE OF PS 24 FLOWS DURING BYPASS OPERATIONS.
- 4. BYPASS PUMP SYSTEM SHALL BE CAPABLE OF PUMPING 3900 GPM AT 180' TDH WITH THE LARGEST PUMP OUT OF SERVICE.
- 5. BYPASS SHALL NOT IMPACT TRAFFIC ON BROWNSVILLE HWY.
- 6. TEMPORARY SHUT DOWN OF PS 24 AND PS 67 IS REQUIRED FOR CONNECTION TO EXIST FORCE MAIN AT STA 277+91; TEMPORARY SHUT DOWN SHALL BE PERFORMED DURING LOW FLOW PERIODS AND UTILIZE TANKER TRUCKS TO TRANSPORT FLOWS TO CKTP.

**SUGGESTED SEQUENCING (SEE APPENDIX A FOR FULL PROJECT CONSTRUCTION SEQUENCE):**

- PHASE 3:**
- 1. COMPLETE CONSTRUCTION OF NEW SSFM FROM STA 230+67 TO STA 277+80. DO NOT CONNECT NEW SSFM TO PS 24 OR EXISTING FORCEMAIN AT STA 277+80.
  - 2. INSTALL PS 24 BYPASS BETWEEN STA 229+58 96" MANHOLE AND NEW STA 1+31 24" PIG LAUNCH VALVE. SEE SPECIFICATION SECTION 01 59 00.
  - 3. COMMENCE TEMPORARY SHUTDOWN OF PS 24 & 67 AND CONNECT NEW SSFM TO EXIST SSFM AT STA 277+91.
  - 4. BEGIN PS 24 BYPASS.
    - A. REMOVE EXISTING SSFM BETWEEN STA 230+67 10'LT AND STA 230+00 AS REQUIRED.
    - B. CONSTRUCT NEW SSFM BETWEEN STA 230+00 AND STA 230+67, INCLUDING CONNECTION TO PS 24.
    - C. PERFORM PS 24 IMPROVEMENTS AND ABANDON EXISTING SSFM WETWELL INLET AS REQUIRED.
  - 5. TERMINATE AND REMOVE PS 24 BYPASS, RESUME NORMAL PS 24 OPERATION.
  - 6. INSTALL NEW PS 24 PIG LAUNCH PIPING AND CONNECT TO NEW SSFM AT STA 1+31 24" PIG LAUNCH VALVE.

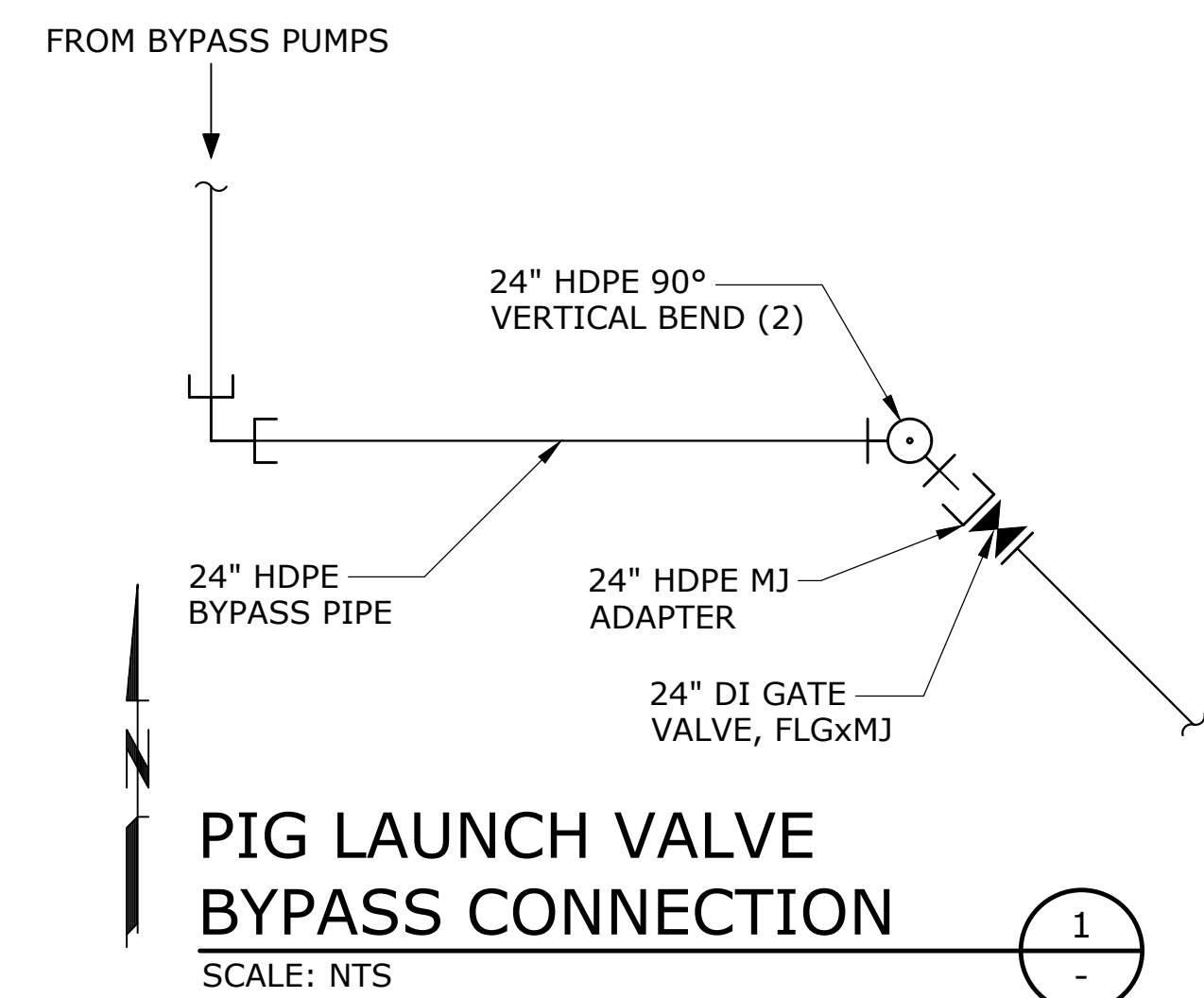

**100% SUBMITTAL**

NO.	DATE	BY	REVISION

NOTICE  
0 1/2 1  
IF THIS BAR DOES NOT MEASURE 1" THEN DRAWING IS NOT TO SCALE

TMH DESIGNED  
MNF DRAWN  
EKS CHECKED

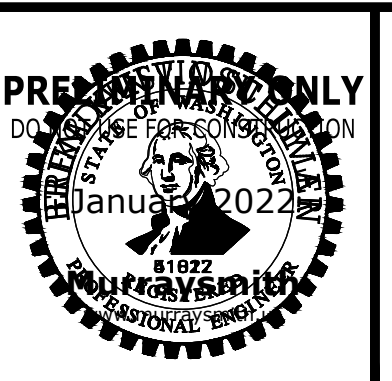

**BANGOR-KEYPORT  
FORCE MAIN  
REPLACEMENT**

**APPENDIX F  
PUMP STATION 24  
SUGGESTED BYPASS PLAN  
- REFERENCE ONLY**

PROJECT NO.: 20-2815 SCALE: AS SHOWN DATE: DECEMBER 2021

SHEET  
**3 OF 3**



*murraysmith*



**TEMPORARY CONSTRUCTION EASEMENTS**

**APPENDIX E**

---

BACK OF COVER  
THIS PAGE INTENTIONALLY LEFT BLANK

**AFTER RECORDING MAIL TO:**

**Robert McGinley  
Kitsap County Public Works  
614 Division Street, MS-26  
Port Orchard WA 98366-4699**

**KITSAP COUNTY PUBLIC WORKS**  
Easement Rec Fee: \$ 207.50  
09/24/2021 10:05 AM  
Paul Andrews, Kitsap Co Auditor

**202109240066**

Page: 1 of 5

**SEWER EASEMENT**

---

**GRANTOR:** CLEAR CREEK MHP, LLC, A WASHINGTON LIMITED LIABILITY COMPANY; KITSAP MHP INVESTMENTS, LLC, MEMBER OF CLEAR CREEK MHP, LLC AND S&P MHP CAPITAL LLC, MANAGER OF KITSAP MHP INVESTMENTS, LLC

**GRANTEE:** KITSAP COUNTY, A POLITICAL SUBDIVISION OF THE STATE OF WASHINGTON

**ABBREVIATED LEGAL:** Portion of the SW¼ of the SW ¼ of Section 33, Township 26N, Range 1 East, W.M., Kitsap County, State of Washington

**PARCEL NO.:** 332601-3-008-2002

---

The Grantor, Clear Creek MHP, LLC, a Washington Limited Liability Company, for and in consideration of **Ten Dollars (\$10.00) and Other Valuable Considerations**, hereby grants and conveys unto Grantee, **Kitsap County, a Political Subdivision of the State of Washington**, and its assigns and successors, a perpetual Sewer Easement for the purpose of installing, accessing, maintaining, operating, repairing and upgrading sanitary sewer facilities and their appurtenances thereto, over, under, upon and across the hereinafter described lands, said lands being situated in the Southwest Quarter of the Southwest Quarter, Section 33, Township 26 North, Range 1 East, W.M., Kitsap County, State of Washington and described as follows:

**Described in EXHIBIT "A" and Depicted in EXHIBIT "B"  
Attached Hereto and by this Reference Made a Part Thereof.**

LEGAL DESCRIPTION APPROVED BY  
KITSAP COUNTY  
DEPARTMENT OF PUBLIC WORKS

*Paul Andrews* 09/20/2021  
BY DATE

**EXCISE TAX EXEMPT SEP 24 2021**

Dated this 31st day of August, 2021.

By: Daniel C. Piantanida  
Daniel C. Piantanida, Manager of S&P MHP Capital LLC

By: \_\_\_\_\_  
Michael D. Simonitch, Manager of S&P MHP Capital LLC

TAX PARCEL NO.: 332601-3-008-2002

STATE OF WASHINGTON

COUNTY OF King } ss

On this 31st day of August, 2021, before me, the undersigned, a Notary Public in and for the State of Washington, duly commissioned and sworn, personally appeared Daniel C. Piantanida, to me known to be the Manager of Clear Creek MHP, LLC, a Washington Limited Liability Company, the company that executed the foregoing instrument, and acknowledged the said instrument to be the free and voluntary act and deed of said corporation, for the uses and purposes therein mentioned, and on oath, stated that he/she/they are authorized to execute the said instrument on behalf of said corporation.

GIVEN under my hand and official seal this 31st day of August, 2021.

Sarah M. Webster  
Notary Public in and for the State of Washington.

Residing at: King County, WA

My Commission Expires: 11/17/2024

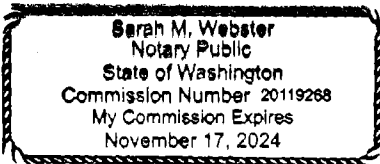

Dated this 31<sup>st</sup> day of August, 2021.

By: \_\_\_\_\_  
Daniel C. Piantanida, Manager of S&P MHP Capital LLC

By:   
\_\_\_\_\_  
Michael D. Simonitch, Manager of S&P MHP Capital LLC

TAX PARCEL NO.: 332601-3-008-2002

STATE OF WASHINGTON

COUNTY OF King } ss

On this 3<sup>rd</sup> day of September, 2021, before me, the undersigned, a Notary Public in and for the State of Washington, duly commissioned and sworn, personally appeared Michael Simonitch, to me known to be the manager of Clear Creek MHP, LLC, a Washington Limited Liability Company, the company that executed the foregoing instrument, and acknowledged the said instrument to be the free and voluntary act and deed of said corporation, for the uses and purposes therein mentioned, and on oath, stated that he/she/they are authorized to execute the said instrument on behalf of said corporation.

GIVEN under my hand and official seal this 3<sup>rd</sup> day of September, 2021.

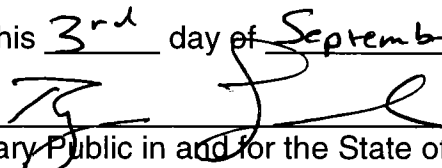
  
\_\_\_\_\_  
Notary Public in and for the State of Washington.

Residing at: King County

My Commission Expires: 4/14/24

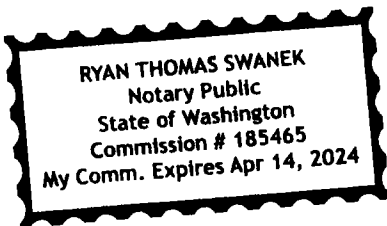

### Exhibit "A" – Legal Description

THAT PORTION OF THE SOUTHEAST QUARTER OF THE SOUTHWEST QUARTER OF THE SOUTHWEST QUARTER OF SECTION 33, TOWNSHIP 26 NORTH, RANGE 1 EAST, W.M., IN KITSAP COUNTY WASHINGTON, DESCRIBED AS FOLLOWS:

A 10 FOOT WIDE STRIP THE WESTERLY LINE OF WHICH IS DESCRIBED AS FOLLOWS:  
COMMENCING AT THE SOUTHWEST CORNER OF SAID SECTION 33; THENCE SOUTH  $88^{\circ}16'27''$  EAST ALONG THE SOUTH LINE THEREOF 913.28 FEET; THENCE NORTH  $12^{\circ}21'53''$  EAST 30.52 FEET TO THE NORTH RIGHT OF WAY LINE OF MOUNTAIN VIEW ROAD AND THE POINT OF BEGINNING OF THIS WESTERLY LINE; THENCE CONTINUING NORTH  $12^{\circ}21'53''$  EAST 647.68 FEET TO THE NORTH LINE OF THE SOUTHEAST QUARTER OF THE SOUTHWEST QUARTER OF THE SOUTHWEST QUARTER OF SAID SECTION 33 AND THE POINT OF TERMINATION OF THIS WESTERLY LINE.



11-16-2020

Exhibit "B" - Depiction

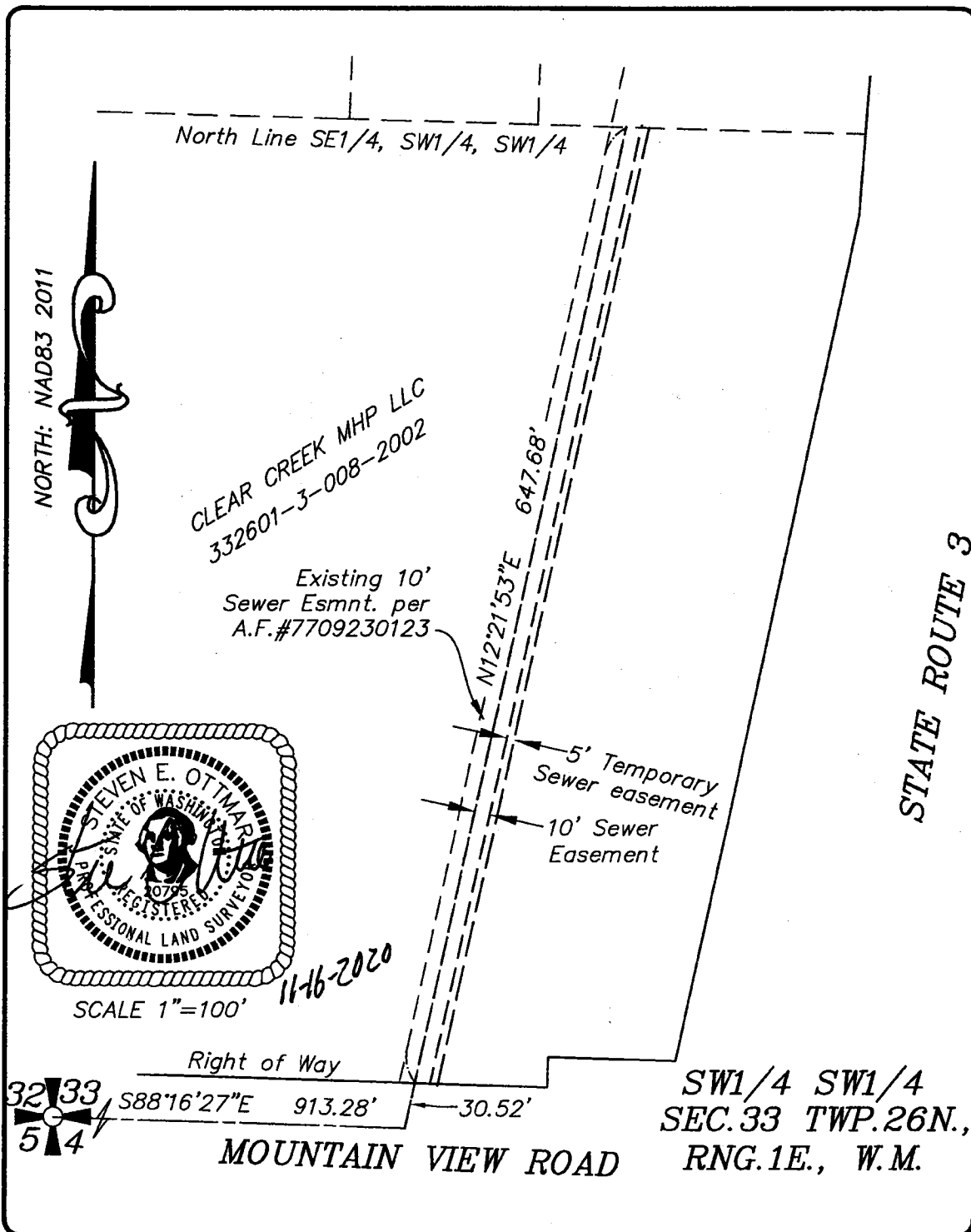

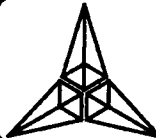
 <p><b>AES</b> CONSULTANTS INC P.O. BOX 930 • SILVERDALE, WA. 98383 • (360)692-6400</p>	<p>Easement Map</p>		<p>DWN BY: B.J.M.</p>	<p>CHK. BY: S.E.O.</p>
	<p>FOR CLEAR CREEK MHP LLC</p>		<p>DATE: 11/16/20</p>	<p>JOB No. 7259</p>

Charity A. Hill

**TEMPORARY CONSTRUCTION EASEMENT**

The undersigned property owner, (hereafter known as the "Grantor"), in consideration of **agreed just compensation**, does hereby grant and convey unto Kitsap County, A Political Subdivision of the State of Washington, (hereinafter known as "Grantee"), a **Temporary Construction Easement** over, under and across the following described lands for the purpose of constructing a sewer force-main and all appurtenances over, under, upon, and across the hereinafter described lands, said lands being associated with the Bangor/Keyport Force-main Rehabilitation Project, CRP # 3668, situated in that portion of SW ¼ of the SW ¼ of Section 33, Township 26N, Range 1E, W.M., Kitsap County, State of Washington

**Property known as Kitsap County Assessor Number: 332601-3-011-2007**

It Is Hereby Agreed As Follows:

1. Kitsap County Kitsap County and/or its assigns shall be constructing the Bangor/Keyport Fore-main Rehabilitation Project. The work requires staff and/or the contractor to temporarily enter certain portions of private property in order to construct a sewer force-main and all appurtenances.
2. The Grantee (Kitsap County) also agrees to indemnify and save harmless the Grantor (property owner) from any liability arising from the activities contemplated herein.
3. In the event that private improvements on the above-described property which have not been addressed in the Project Construction Plans, or have already received compensation, are disturbed or destroyed, they will be replaced in as good condition as they were immediately before the property was entered upon, or compensation shall be made for their replacement by Kitsap County.
4. This Temporary Construction Easement shall be in effect for **Two Years from the date on which construction activities commence on the Grantor's property or until the project is completed, whichever occurs first.** The property owner assumes no obligation under this agreement other than granting access for completion of these tasks.

Dated this 28<sup>th</sup> day of April, 2021.

  
\_\_\_\_\_  
Grantor (s)

Contact Person: Charity Hill

Phone: 360 620 7241

Other Information: \_\_\_\_\_

\_\_\_\_\_



AFTER RECORDING MAIL TO:

Robert McGinley  
Kitsap County Public Works  
614 Division Street, MS-26  
Port Orchard WA 98366-4699

KITSAP COUNTY PUBLIC WORKS  
Easement Rec Fee: \$ 206.50  
09/24/2021 10:05 AM  
Paul Andrews, Kitsap Co Auditor

202109240065

Page: 1 of 4

## SEWER EASEMENT

---

GRANTOR: ZACHARY ANDREW STEWART, A SINGLE PERSON

GRANTEE: KITSAP COUNTY, A POLITICAL SUBDIVISION OF THE STATE OF WASHINGTON

ABBREVIATED LEGAL: Portion of the SW $\frac{1}{4}$  of the SW  $\frac{1}{4}$  of Section 33, Township 26N, Range 1 East, W.M., Kitsap County, State of Washington

PARCEL NO.: 332601-3-012-2006

---

The Grantor, **Zachary Andrew Stewart, a single person**, for and in consideration of **Ten Dollars (\$10.00) and Other Valuable Considerations**, hereby grants and conveys unto Grantee, **Kitsap County, a Political Subdivision of the State of Washington**, and its assigns and successors, a perpetual Sewer Easement for the purpose of installing, accessing, maintaining, operating, repairing and upgrading sanitary sewer facilities and their appurtenances thereto, over, under, upon and across the hereinafter described lands, said lands being situated in the Southwest Quarter of the Southwest Quarter, Section 33, Township 26 North, Range 1 East, W.M., Kitsap County, State of Washington and described as follows:

**Described in EXHIBIT "A" and Dipped in EXHIBIT "B"  
Attached Hereto and by this Reference Made a Part Thereof.**

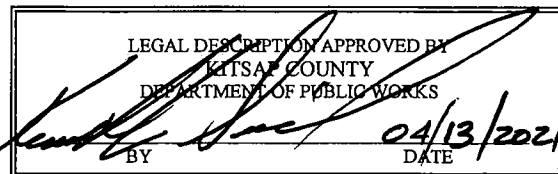

**EXCISE TAX EXEMPT SEP 24 2021**

Dated this 01 day of JUNE, 2021.

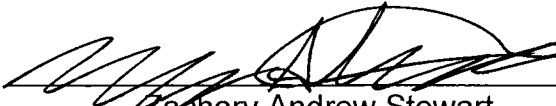
By:   
Zachary Andrew Stewart

TAX PARCEL NO.: 332601-3-012-2006

STATE OF WASHINGTON  
} ss  
COUNTY OF KITSAP

On this day personally appeared before me Zachary A Stewart to me known to be the individuals described in and who executed the within and foregoing instrument and acknowledged that he signed the same as himself free and voluntary act and deed, for the uses and purposes therein mentioned.

GIVEN under my hand and official seal this 01 day of June, 2021.



  
Notary Public in and for the State of Washington.

Residing at: Silverdale

My Commission Expires: 08/19/2023

## Exhibit "A" – Legal Description

THAT PORTION OF THE NORTH HALF OF THE NORTHEAST QUARTER OF THE SOUTHWEST QUARTER OF THE SOUTHWEST QUARTER, SECTION 33, TOWNSHIP 26 NORTH, RANGE 1 EAST, W.M., IN KITSAP COUNTY, WASHINGTON, DESCRIBED AS FOLLOWS:

A 10 FOOT WIDE STRIP THE WESTERLY LINE OF WHICH IS DESCRIBED AS FOLLOWS:  
COMMENCING AT THE SOUTHWEST CORNER OF SAID SECTION 33, TOWNSHIP 26 NORTH, RANGE 1 EAST, W.M.; THENCE SOUTH  $88^{\circ}16'27''$  EAST ALONG THE SOUTH LINE THEREOF 913.28 FEET; THENCE NORTH  $12^{\circ}21'53''$  EAST 1001.89 FEET; THENCE NORTH  $32^{\circ}38'07''$  WEST 17.79 FEET; THENCE NORTH  $12^{\circ}26'35''$  EAST 0.62 FEET TO THE SOUTH LINE OF THE ABOVE DESCRIBED PARCEL AND THE POINT OF BEGINNING OF THIS WESTERLY LINE; THENCE CONTINUING NORTH  $12^{\circ}26'35''$  EAST 54.26 FEET; THENCE NORTH  $57^{\circ}21'53''$  EAST 17.68 FEET; THENCE NORTH  $12^{\circ}21'53''$  EAST 272.65 FEET TO THE NORTH LINE OF THE ABOVE DESCRIBED PARCEL AND THE POINT OF TERMINATION OF THIS WESTERLY LINE.

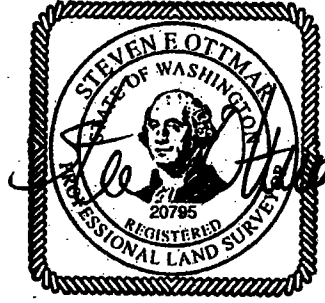

11-16-2020

Exhibit "B" - Depiction

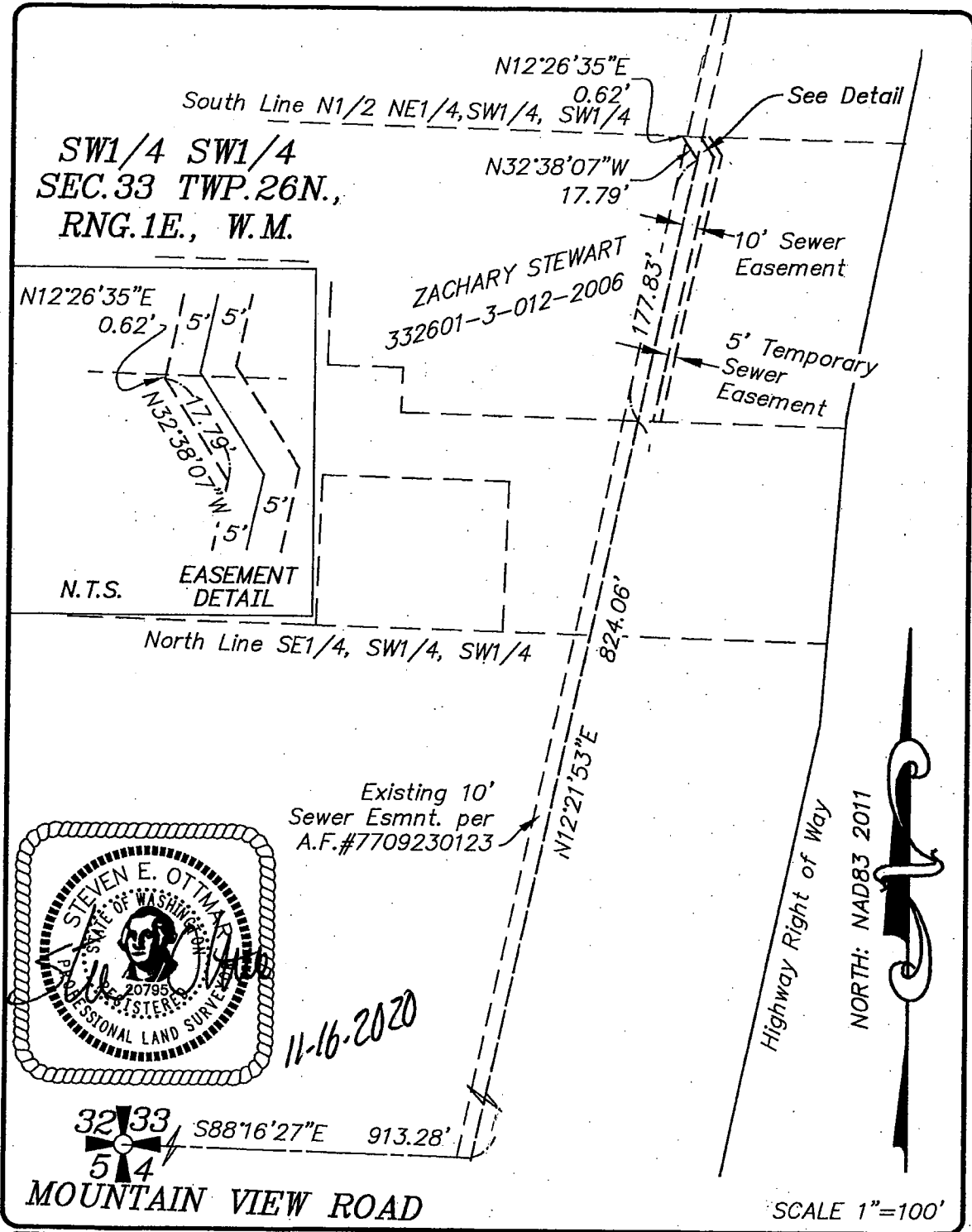

11-16-2020

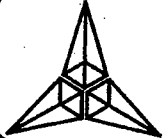
 <p><b>AES</b> CONSULTANTS INC P.O. BOX 930 • SILVERDALE, WA. 98383 • (360)692-6400</p>	<p>Easement Map</p>	<p>DWN BY: B.J.M.</p>	<p>CHK. BY: S.E.O.</p>
	<p>FOR ZACHARY STEWART</p>	<p>DATE: 11/16/20</p>	<p>JOB No. 7259</p>

Keith & Jody Foris

TEMPORARY CONSTRUCTION EASEMENT

The undersigned property owner, (hereafter known as the "Grantor"), in consideration of **agreed just compensation**, does hereby grant and convey unto Kitsap County, A Political Subdivision of the State of Washington, (hereinafter known as "Grantee"), a **Temporary Construction Easement** over, under and across the following described lands for the purpose of constructing a sewer force-main and all appurtenances over, under, upon, and across the hereinafter described lands, said lands being associated with the Bangor/Keyport Fore-main Rehabilitation Project, CRP # 3668, situated in that portion of SW ¼ of the SW ¼ of Section 33, Township 26N, Range 1E, W.M., Kitsap County, State of Washington

Property known as Kitsap County Assessor Number: 332601-3-013-2005

It Is Hereby Agreed As Follows:

1. Kitsap County Kitsap County and/or its assigns shall be constructing the Bangor/Keyport Fore-main Rehabilitation Project. The work requires staff and/or the contractor to temporarily enter certain portions of private property in order to construct a sewer force-main and all appurtenances.
2. The Grantee (Kitsap County) also agrees to indemnify and save harmless the Grantor (property owner) from any liability arising from the activities contemplated herein.
3. In the event that private improvements on the above-described property which have not been addressed in the Project Construction Plans, or have already received compensation, are disturbed or destroyed, they will be replaced in as good condition as they were immediately before the property was entered upon, or compensation shall be made for their replacement by Kitsap County.
4. This Temporary Construction Easement shall be in effect for **Two Years from the date on which construction activities commence on the Grantor's property or until the project is completed, whichever occurs first.** The property owner assumes no obligation under this agreement other than granting access for completion of these tasks.

Dated this 29 day of APRIL, 2021.

  
\_\_\_\_\_  
Grantor (s)

Contact Person: JODY K. FORIS

Phone: (360) 440 0835

Other Information: \_\_\_\_\_

\_\_\_\_\_

**AFTER RECORDING MAIL TO:**

**Robert McGinley  
Kitsap County Public Works  
614 Division Street, MS-26  
Port Orchard WA 98366-4699**

**KITSAP COUNTY PUBLIC WORKS**  
Easement Rec Fee: \$ 205.50  
09/24/2021 10:05 AM  
Paul Andrews, Kitsap Co Auditor

**202109240067**

Page: 1 of 3

**SEWER EASEMENT**

---

GRANTOR: COUNTRY COMMONS HOMEOWNERS ASSOCIATION

GRANTEE: KITSAP COUNTY, A POLITICAL SUBDIVISION OF THE STATE OF WASHINGTON

ABBREVIATED LEGAL: Portion of the NW $\frac{1}{4}$  and the NE $\frac{1}{4}$  of the SW $\frac{1}{4}$  of Section 33, Township 26N, Range 1 East, W.M., Kitsap County, State of Washington

PARCEL NO.: 5309-000-023-0000

---

The Grantor, **Country Commons Homeowners Association**, for and in consideration of **Ten and No/100 Dollars (\$10.00) and Other Valuable Considerations**, hereby grants and conveys unto Grantee, **Kitsap County, A Political Subdivision of the State of Washington**, and/or its assigns and successors, a perpetual Sewer Easement for the purpose of installing, accessing, maintaining, operating, repairing and upgrading sanitary sewer facilities and their appurtenances thereto, over, under, upon and across the hereinafter described lands, said lands being situated in the Northwest Quarter and the Northeast Quarter of Southwest Quarter of Section 33, Township 26N, Range 1 East, W.M., Kitsap County, State of Washington and described as follows:

**Described in EXHIBIT "A" and Depicted in EXHIBIT "B"  
Attached Hereto and by this Reference Made a Part Thereof.**

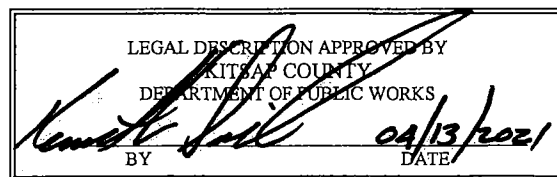

**EXCISE TAX EXEMPT SEP 24 2021**

Dated this 19 day of August, 2021.

By: Jean Baughman

TAX PARCEL NO.: 5309-000-023-0000

STATE OF WASHINGTON

} ss

COUNTY OF KITSAP

On this 19<sup>th</sup> day of August, 2021, before me, the undersigned, a Notary Public in and for the State of Washington duly commissioned and sworn, personally appeared Jean Baughman, to me known to be the President of Country Commons Homeowners Association that executed the foregoing instrument, and acknowledged the said instrument to be the free and voluntary act and deed of said corporation, for the uses and purposes therein mentioned, and on oath, stated that he/she/they are authorized to execute the said instrument on behalf of said corporation.

GIVEN under my hand and official seal this 19<sup>th</sup> day of August, 2021.



Robert A. McGinley  
Notary Public in and for the State of Washington  
Residing at: Port Orchard, WA  
My Commission Expires: 11-1-21

**Exhibit "A" – Legal Description**

THAT PORTION OF TRACT A (OPEN SPACE) COUNTRY COMMONS ACCORDING TO THE PLAT RECORDED IN VOLUME 28 OF PLATS, PAGES 240, 241 AND 242, BEING AN AMENDMENT OF THE PLAT RECORDED I VOLUME 28 OF PLATS, PAGES, 180, 181 AND 182 RECORDS OF KITSAP COUNTY WASHINGTON, BEING A PORTION OF THE NORTHWEST QUARTER OF THE SOUTHWEST QUARTER, SECTION 33, TOWNSHIP 26 NORTH, RANGE 1 EAST, W.M., DESCRIBED AS FOLLOWS:

A 10 FOOT WIDE STRIP THE WESTERLY AND NORTHERLY LINE OF WHICH IS DESCRIBED AS FOLLOWS: COMMENCING AT THE SOUTHWEST CORNER OF SAID SECTION 33; THENCE SOUTH 88°16'27" EAST ALONG THE SOUTH LINE THEREOF 913.28 FEET; THENCE NORTH 12°21'53" EAST 1354.52 FEET TO THE SOUTH LINE OF THE SAID PLAT OF COUNTRY COMMONS AND THE POINT OF BEGINNING OF THIS WESTERLY LINE; THENCE NORTH 12°21'53" EAST 390.42 FEET; THENCE SOUTH 83°57'09" EAST 174.67 FEET TO THE WEST RIGHT OF WAY LINE OF STATE ROUTE 3 AND THE POINT OF TERMINATION OF THIS WESTERLY AND NORTHERLY LINE.



1-6-2021



Country Commons HOA

TEMPORARY CONSTRUCTION EASEMENT

The undersigned property owner, (hereafter known as the "Grantor"), in consideration of **agreed just compensation**, does hereby grant and convey unto Kitsap County, A Political Subdivision of the State of Washington, (hereinafter known as "Grantee"), a **Temporary Construction Easement** over, under and across the following described lands for the purpose of constructing a sewer force-main and all appurtenances over, under, upon, and across the hereinafter described lands, said lands being associated with the Bangor/Keyport Force-main Rehabilitation Project, CRP # 3668, situated in that portion of the NW¼ and the NE¼ of the SW¼ of Section 33, Township 26N, Range 1E, W.M., Kitsap County, State of Washington

Property known as Kitsap County Assessor Number: 5309-000-023-0000

It Is Hereby Agreed As Follows:

1. Kitsap County Kitsap County and/or its assigns shall be constructing the Bangor/Keyport Fore-main Rehabilitation Project. The work requires staff and/or the contractor to temporarily enter certain portions of private property in order to construct a sewer force-main and all appurtenances.
2. The Grantee (Kitsap County) also agrees to indemnify and save harmless the Grantor (property owner) from any liability arising from the activities contemplated herein.
3. In the event that private improvements on the above-described property which have not been addressed in the Project Construction Plans, or have already received compensation, are disturbed or destroyed, they will be replaced in as good condition as they were immediately before the property was entered upon, or compensation shall be made for their replacement by Kitsap County.
4. This Temporary Construction Easement shall be in effect for **Two Years from the date on which construction activities commence on the Grantor's property or until the project is completed, whichever occurs first.** The property owner assumes no obligation under this agreement other than granting access for completion of these tasks.

Dated this 19 day of August, 2021.

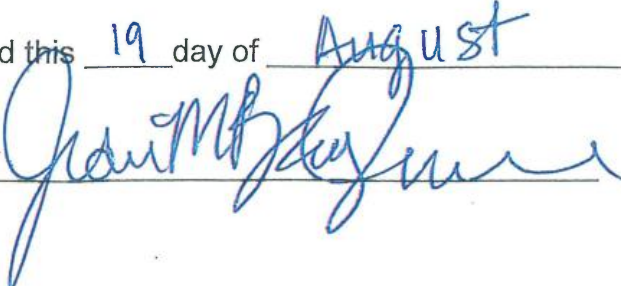
By: 

Contact Person: \_\_\_\_\_

Phone: \_\_\_\_\_

Other Information: \_\_\_\_\_  
\_\_\_\_\_

Exhibit "B" - Depiction

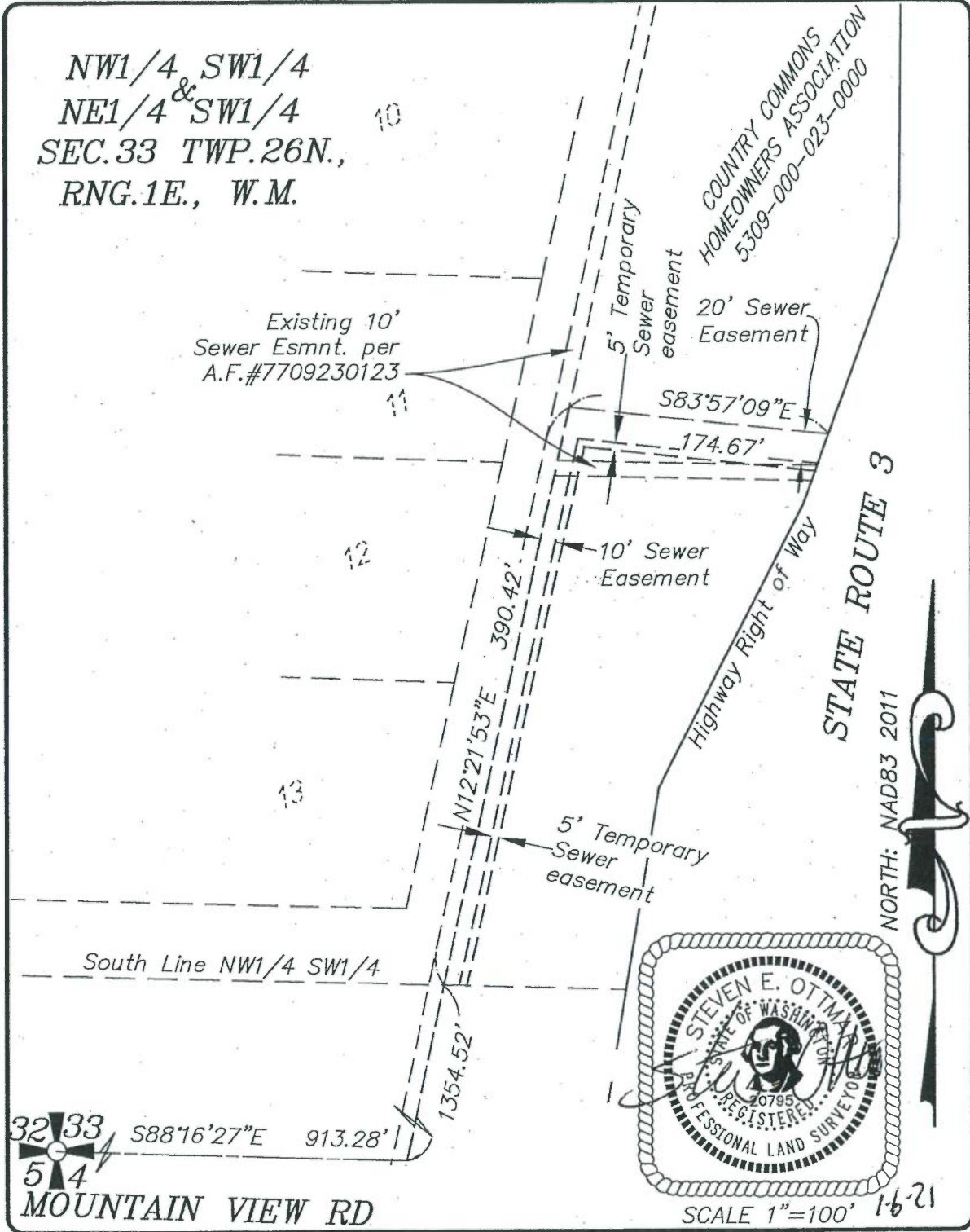

**AES**  
CONSULTANTS INC  
P.O. BOX 930 • SILVERDALE, WA. 98383 • (360)892-6400

Easement Map FOR COUNTRY COMMONS HOMEOWNERS ASSOC.	DWN BY: B.J.M.	CHK. BY: S.E.O.
	DATE: 1/05/21	JOB No. 7259

Liam Carter & Laura Reachard

**TEMPORARY CONSTRUCTION EASEMENT**

The undersigned property owner, (hereafter known as the "Grantor"), in consideration of **Mutual Benefits**, does hereby grant and convey unto Kitsap County, A Political Subdivision of the State of Washington, (hereinafter known as "Grantee"), a **Temporary Construction Easement** over, under and across the following described lands for the purpose of constructing sanitary sewer improvements associated with the Bangor–Keyport Forcemain Replacement Project, situated in that portion of Government Lot 7, Section 35, Township 26 North, Range 1 East, W.M., Kitsap County, State of Washington.

**Property known as Kitsap County Assessor Number: 352601-4-016-2008**

It Is Hereby Agreed As Follows:

1. Kitsap County and/or its assigns shall be constructing the Bangor–Keyport Forcemain Replacement Project. The work requires staff and/or assigns to temporarily enter private property in order to perform work in accordance with the above-referenced project, remove and/or relocate private improvements reconstruct existing driveway approaches, and inspect and connect to the existing side sewer.
2. The Grantee (Kitsap County) also agrees to indemnify and save harmless the Grantor (property owner) from any liability arising from the activities contemplated herein.
3. In the event that private improvements (excluding native vegetation) on the above-described private property which have not been addressed in the project construction plans are disturbed or destroyed, they will be replaced in as good as, or better condition as they were immediately before the property was entered upon by Kitsap County and/or assigns.
4. This Temporary Construction Easement shall be in effect from the start of construction on your property for a period six months or until the restoration or project is completed, whichever is sooner. The property owner assumes no obligation under this agreement other than granting access for completion of these tasks.

Dated this 19 day of January, 2022.

Liam S. Carter, Laura Reachard  
Grantor (s)

Contact Person: Liam S. Carter

Phone: 360-621-1233

Other Information: \_\_\_\_\_

\_\_\_\_\_

Keith Hawryluk

TEMPORARY CONSTRUCTION EASEMENT

The undersigned property owner, (hereafter known as the "Grantor"), in consideration of **Mutual Benefits**, does hereby grant and convey unto Kitsap County, A Political Subdivision of the State of Washington, (hereinafter known as "Grantee"), a **Temporary Construction Easement** over, under and across the following described lands for the purpose of constructing sanitary sewer improvements associated with the Bangor–Keyport Forcemain Replacement Project, situated in that portion of Government Lot 7, Section 35, Township 26 North, Range 1 East, W.M., Kitsap County, State of Washington.

Property known as Kitsap County Assessor Number: 5060-000-033-0007

It Is Hereby Agreed As Follows:

1. Kitsap County and/or its assigns shall be constructing the Bangor–Keyport Forcemain Replacement Project. The work requires staff and/or assigns to temporarily enter private property in order to perform work in accordance with the above-referenced project, remove and/or relocate private improvements reconstruct existing driveway approaches, and inspect and connect to the existing side sewer.
2. The Grantee (Kitsap County) also agrees to indemnify and save harmless the Grantor (property owner) from any liability arising from the activities contemplated herein.
3. In the event that private improvements (excluding native vegetation) on the above-described private property which have not been addressed in the project construction plans are disturbed or destroyed, they will be replaced in as good as, or better condition as they were immediately before the property was entered upon by Kitsap County and/or assigns.
4. This Temporary Construction Easement shall be in effect from the start of construction on your property for a period six months or until the restoration or project is completed, whichever is sooner. The property owner assumes no obligation under this agreement other than granting access for completion of these tasks.

Dated this 18 day of JANUARY, 2022.

KEITH HAWRYLUK   
Grantor (s)

Contact Person: KEITH HAWRYLUK

Phone: 360-516-8723

Other Information: khawryluk56@gmail.com

---

Lance & Karen Oldham

**TEMPORARY CONSTRUCTION EASEMENT**

The undersigned property owner, (hereafter known as the "Grantor"), in consideration of **Mutual Benefits**, does hereby grant and convey unto Kitsap County, A Political Subdivision of the State of Washington, (hereinafter known as "Grantee"), a **Temporary Construction Easement** over, under and across the following described lands for the purpose of constructing sanitary sewer improvements associated with the Bangor–Keyport Forcemain Replacement Project, situated in that portion of Government Lot 7, Section 35, Township 26 North, Range 1 East, W.M., Kitsap County, State of Washington.

**Property known as Kitsap County Assessor Number: 352601-4-063-2000**

It Is Hereby Agreed As Follows:

1. Kitsap County and/or its assigns shall be constructing the Bangor–Keyport Forcemain Replacement Project. The work requires staff and/or assigns to temporarily enter private property in order to perform work in accordance with the above-referenced project, remove and/or relocate private improvements reconstruct existing driveway approaches, and inspect and connect to the existing side sewer.
2. The Grantee (Kitsap County) also agrees to indemnify and save harmless the Grantor (property owner) from any liability arising from the activities contemplated herein.
3. In the event that private improvements (excluding native vegetation) on the above-described private property which have not been addressed in the project construction plans are disturbed or destroyed, they will be replaced in as good as, or better condition as they were immediately before the property was entered upon by Kitsap County and/or assigns .
4. This Temporary Construction Easement shall be in effect from the start of construction on your property for a period six months or until the restoration or project is completed, whichever is sooner. The property owner assumes no obligation under this agreement other than granting access for completion of these tasks.

Dated this 15 day of JAN, 2022.

LANCE & KAREN OLDHAM

Grantor (s)

Contact Person: LANCE OR KAREN OLDHAM

Phone: 360-779-7289

Other Information: COMMENTS & CONCERNS ON-FILE

**Jeffrey & Rebecca Kehring**

**TEMPORARY CONSTRUCTION EASEMENT**

The undersigned property owner, (hereafter known as the "Grantor"), in consideration of **Mutual Benefits**, does hereby grant and convey unto Kitsap County, A Political Subdivision of the State of Washington, (hereinafter known as "Grantee"), a **Temporary Construction Easement** over, under and across the following described lands for the purpose of constructing sanitary sewer improvements associated with the Bangor–Keyport Forcemain Replacement Project, situated in that portion of Government Lot 7, Section 35, Township 26 North, Range 1 East, W.M., Kitsap County, State of Washington.

**Property known as Kitsap County Assessor Number: 5060-000-032-0008**

It Is Hereby Agreed As Follows:

1. Kitsap County and/or its assigns shall be constructing the Bangor–Keyport Forcemain Replacement Project. The work requires staff and/or assigns to temporarily enter private property in order to perform work in accordance with the above-referenced project, remove and/or relocate private improvements reconstruct existing driveway approaches, and inspect and connect to the existing side sewer.
2. The Grantee (Kitsap County) also agrees to indemnify and save harmless the Grantor (property owner) from any liability arising from the activities contemplated herein.
3. In the event that private improvements (excluding native vegetation) on the above-described private property which have not been addressed in the project construction plans are disturbed or destroyed, they will be replaced in as good as, or better condition as they were immediately before the property was entered upon by Kitsap County and/or assigns.
4. This Temporary Construction Easement shall be in effect from the start of construction on your property for a period six months or until the restoration or project is completed, whichever is sooner. The property owner assumes no obligation under this agreement other than granting access for completion of these tasks.

Dated this 18<sup>th</sup> day of JANUARY, 2022.

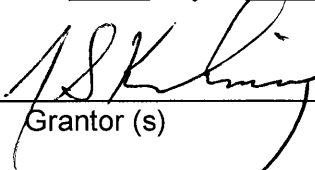
  
\_\_\_\_\_  
Grantor (s)

Contact Person: JEFF KEHRING 

Phone: 360-930-1468-CELL 360-394-2351-HOME

Other Information: \_\_\_\_\_  
\_\_\_\_\_

**Michael & Lynn Decker**

**TEMPORARY CONSTRUCTION EASEMENT**

The undersigned property owner, (hereafter known as the "Grantor"), in consideration of **Mutual Benefits**, does hereby grant and convey unto Kitsap County, A Political Subdivision of the State of Washington, (hereinafter known as "Grantee"), a **Temporary Construction Easement** over, under and across the following described lands for the purpose of constructing sanitary sewer improvements associated with the Bangor–Keyport Forcemain Replacement Project, situated in that portion of Government Lot 7, Section 35, Township 26 North, Range 1 East, W.M., Kitsap County, State of Washington.

**Property known as Kitsap County Assessor Number: 352601-4-002-2004**

It Is Hereby Agreed As Follows:

1. Kitsap County and/or its assigns shall be constructing the Bangor–Keyport Forcemain Replacement Project. The work requires staff and/or assigns to temporarily enter private property in order to perform work in accordance with the above-referenced project, remove and/or relocate private improvements reconstruct existing driveway approaches, and inspect and connect to the existing side sewer.
2. The Grantee (Kitsap County) also agrees to indemnify and save harmless the Grantor (property owner) from any liability arising from the activities contemplated herein.
3. In the event that private improvements (excluding native vegetation) on the above-described private property which have not been addressed in the project construction plans are disturbed or destroyed, they will be replaced in as good as, or better condition as they were immediately before the property was entered upon by Kitsap County and/or assigns.
4. This Temporary Construction Easement shall be in effect from the start of construction on your property for a period six months or until the restoration or project is completed, whichever is sooner. The property owner assumes no obligation under this agreement other than granting access for completion of these tasks.

Dated this 20 day of JANUARY, 2022.

MICHAEL & LYNN DECKER

Grantor (s)

Contact Person: MICHAEL L. DECKER

Phone: (360) 689 4396

Other Information: \* Please advise us about mail box placement. M. Decker





BACK OF COVER  
THIS PAGE INTENTIONALLY LEFT BLANK

# **Geotechnical Engineering Report Bangor-Keyport Force Main Replacement Kitsap County, Washington**

September 3, 2020

Prepared for

Murraysmith, Inc.  
600 Union Street, Suite 300  
Seattle, Washington 98101



955 Malin Lane SW, Suite B  
Tumwater, WA 98501  
(360) 791-3178

# Geotechnical Engineering Report Bangor-Keyport Force Main Replacement Kitsap County, Washington

This document was prepared by, or under the direct supervision of, the undersigned, whose seal is affixed below.

Name: Benjamin Ford, PE  
Washington/No. 56249

Date: September 3, 2020



Document prepared by: Annabel Warnell Annabel Warnell, EIT  
Primary Author

Document reviewed by: Ben J Ford Benjamin Ford, PE  
Quality Reviewer

Date: September 3, 2020  
Project No.: 1490005.010.013  
File path: Y:\1490\005.010\R\Signature Page.docx  
Project Coordinator: MCS

## TABLE OF CONTENTS

	<u>Page</u>
1.0 INTRODUCTION .....	1-1
1.1 Project Understanding.....	1-1
1.2 Scope of Services .....	1-1
2.0 SITE CONDITIONS .....	2-1
2.1 Geologic Setting.....	2-1
2.2 Surface Conditions.....	2-1
2.3 Subsurface Explorations .....	2-1
2.3.1 Soil Conditions.....	2-2
2.3.2 Groundwater Conditions.....	2-3
3.0 CONCLUSIONS AND RECOMMENDATIONS.....	3-1
3.1 Earthwork .....	3-1
3.1.1 Site Soil.....	3-2
3.1.1.1 Utility Trench Excavation and Support .....	3-2
3.1.1.2 Pipe Foundation Support .....	3-3
3.1.1.3 Pipe Bedding and Backfill .....	3-3
3.1.2 Construction Dewatering .....	3-3
3.2 Temporary Shoring.....	3-4
3.3 Trenchless Installation.....	3-5
3.3.1 Horizontal Directional Drilling.....	3-5
3.3.2 Pipe Jacking and Microtunneling.....	3-6
3.3.3 Auger Boring.....	3-7
4.0 CONSTRUCTION SUPPORT .....	4-1
5.0 USE OF THIS REPORT.....	5-1
6.0 REFERENCES.....	6-1

---

## FIGURES

<u>Figure</u>	<u>Title</u>
1	Vicinity Map
2	Proposed Sewer Main Replacement Alignment
3A	Summary Site and Exploration Plan
3B–H	Site and Exploration Plans B–H and Geologic Cross Sections

## TABLES

<u>Table</u>	<u>Title</u>
1	Recommended Soil Parameters for Design of Temporary Shoring
2	Recommended Soil Engineering Properties

## APPENDICES

<u>Appendix</u>	<u>Title</u>
A	Field Explorations
B	Laboratory Testing
C	Photographs of Rotasonic™ Boring Samples

## LIST OF ABBREVIATIONS AND ACRONYMS

ASTM.....	ASTM International
bgs.....	below ground surface
County.....	Kitsap County Public Works Sewer Utility Division
ft .....	foot/feet
HDD.....	horizontal directional drilling
HDPE .....	high-density polyethylene
LAI .....	Landau Associates, Inc.
pcf .....	pounds per cubic foot
psf .....	pounds per square foot
SR.....	State Route
USCS.....	Unified Soil Classification System
WAC .....	Washington Administrative Code
WSDOT .....	Washington State Department of Transportation

This page intentionally left blank.

---

## 1.0 INTRODUCTION

This report summarizes the results of geotechnical engineering services provided by Landau Associates, Inc. (LAI) in support of the Bangor-Keyport Force Main Replacement project in Kitsap County, Washington. This report has been prepared with information provided by representatives of Murraysmith, Inc. (project civil engineer) and with data collected during LAI's geotechnical field investigation and laboratory testing programs.

### 1.1 Project Understanding

At several locations along the existing alignment that serves North Kitsap County (site; Figure 1), the force main transitions from a pressurized flow (full flow) to an open-channel flow (partially full flow). The change from full to partial flow allows hydrogen sulfide to collect and corrode portions of the force main. The Kitsap County Public Works Sewer Utility Division (County; project owner) proposes to replace approximately 5 miles of the force main to mitigate corrosion.

Portions of the existing force main will be replaced with 24- to 30-inch-diameter, high-density polyethylene (HDPE) pipe. Where feasible, the existing pipe will be replaced in a parallel alignment; in areas of limited access, the pipe will be replaced in kind. Open-trench construction will be used to install the majority of the replacement pipe. Excavations are anticipated to extend 5 to 10 feet (ft) below ground surface (bgs), but may be deeper in some areas. The portion of sewer main that crosses beneath State Route (SR) 3 may be installed with horizontal directional drilling (HDD), a trenchless installation technique. Soil conditions at the SR-3 crossing are anticipated to be difficult, and pipe jacking and microtunneling installation techniques are also being considered. The proposed force main alignment is shown on Figure 2.

The replacement force main will be connected to air-vacuum structures, pump stations, and individual pump stations. Existing wet wells and other structures located at County facilities (i.e., pump stations) will be rehabilitated and/or upgraded, if needed. Deep excavations (greater than 10 ft bgs) are not anticipated for rehabilitation/upgrading of the existing facilities. Other proposed improvements may include utility relocation and pavement installation.

### 1.2 Scope of Services

LAI performed geotechnical services in accordance with the scope outlined in Attachment A of the Task Order under Agreement for Services on Continuing Basis, dated April 29, 2020.



---

## 2.0 SITE CONDITIONS

The following sections describe the geologic setting of the site and the surface and subsurface conditions observed during LAI's field investigation. Interpretations of site conditions are based on LAI's review of available geologic and geotechnical information and on the results of the site reconnaissance, subsurface explorations, and geotechnical laboratory testing.

### 2.1 Geologic Setting

Geologic information for the site and the surrounding area was obtained from the *Geologic Map of the Seabeck and Poulsbo 7.5-minute Quadrangles, Kitsap and Jefferson Counties, Washington* (Polenz et. al 2013). According to the map, surficial deposits along the project alignment include:

- **Ice-contact Deposits (Qgic):** This unit generally consists of poorly to well-sorted cobbles and pebble gravel, sand, lacustrine mud, and isolated boulders. Ice-contact deposits may include ablation or flow till.
- **Glacial Till (Qgt):** This unit typically consists of highly compact clay, silt, sand, pebbles, cobbles, and isolated boulders, suspended in a sandy or muddy matrix.
- **Pre-Vashon Recessional Outwash (Qpos):** This unit generally consists of medium- to fine-grained sand, sometimes pebbly and silty, with occasional cobbles and boulders.
- **Pre-Vashon Silt (Qpf):** This unit typically consists of compact silt, clay, and sand with occasional dropstones.
- **Peat (Qp):** This unit generally consists of organics and organic-rich sediment, including silt, clay, and wetland deposits.

The soils observed in LAI's explorations were generally consistent with the mapped geology. Fill was also observed in some of the explorations. Peat deposits were not observed in the explorations, but may be present along the project alignment.

### 2.2 Surface Conditions

Surface conditions along the project alignment include asphalt-paved roads and highways and grassy fields. The general area surrounding the project alignment consists of residential housing and commercial businesses. Topography is variable along the project alignment, as shown on Figures 3B through 3H.

### 2.3 Subsurface Explorations

In May 2020, LAI explored subsurface conditions along the project alignment by advancing 20 hollow-stem auger borings (B-1 through B-4, B-9 and B-10, and B-12 through B-25) 11.5 to 26.5 ft bgs, four Rotosonic™ borings (B-5 through B-8) 60.0 to 61.5 ft bgs, and one hand-auger boring (HA-11) 2.0 ft bgs. The approximate locations of the explorations are shown on Figure 3A.

LAI personnel monitored the field explorations, collected representative soil samples, and maintained a detailed record of the subsurface soil and groundwater conditions observed. Additional information about the field explorations, including summary boring logs, is provided in Appendix A.

Samples were transported to LAI's soils laboratory for further examination and testing. The results of LAI's geotechnical laboratory testing program are summarized in Appendix B.

### 2.3.1 Soil Conditions

The soils observed underlying existing surface conditions (i.e., asphalt pavement, gravel surfacing, or sod/topsoil) were categorized into five general units:

- **Fill:** Fill was observed in borings B-5 through B-8, B-14, B-21 through B-23, and HA-11. The fill consisted of sand with variable silt and gravel content or gravel with variable silt, sand, and organic content in a medium dense to dense, moist to wet condition. The majority of the fill observed along the project alignment extended between 1.5 and 5.5 ft bgs; the fill extended up to 30 ft bgs where the alignment crosses SR-3.
- **Ice-contact Deposits:** Ice-contact deposits were observed in borings B-1 through B-4, B-9, B-10, B-12, B-25, and HA-11. The ice-contact deposits consisted of sand with variable silt, gravel, and organic content; very sandy gravel with variable silt content; clay; or silt with sand and variable gravel content. The deposits ranged from moist to wet and medium dense to very dense or stiff to very stiff. Borings that contained ice-contact deposits terminated in this unit.
- **Recessional Outwash:** Recessional outwash was observed in borings B-15 through B-17, B-20, B-21, B-23, and B-24. The recessional outwash consisted of sand with variable silt and gravel content or silt with variable sand content in a damp to moist, loose to medium dense or medium stiff to very stiff condition. Borings that contained recessional outwash terminated in this unit.
- **Pre-Vashon Silt:** Pre-Vashon silt was observed in borings B-18 and B-22. The Pre-Vashon silt consisted of silt with variable sand and gravel content in a medium stiff to stiff, damp to moist condition. Both borings terminated in this unit.
- **Glacial Till:** Glacial till was observed in borings B-5 through B-8, B-13, B-14, and B-19. The glacial till consisted of sand with variable silt and gravel content; silty, sandy gravel; or silt with sand and variable gravel content. Fractured rock and cobbles, approximately 3 inches in diameter, were observed in this unit. The glacial till was dense to very dense or hard and moist to wet. Borings that contained glacial till terminated in this unit.

Scattered cobbles, approximately 3 inches in diameter, were observed in the samples collected from borings B-5 through B-8. Cobbles and fractured rock were observed intermittently from 7 to 59 ft bgs. Significant drilling chatter and pulverized rock were observed in boring B-6, suggesting the presence of large cobbles and possibly boulders. Cobbles and boulders are often found in glacially derived soils and could be present along the project alignment.

### **2.3.2 Groundwater Conditions**

Groundwater was observed in LAI's May 2020 field explorations. The majority of groundwater was observed between 8 and 25 ft bgs; groundwater was observed between 30 and 50 ft bgs where the project alignment crosses SR-3. Slow groundwater seepage was observed at approximately 1 ft bgs in boring HA-11. Groundwater at time of drilling is shown on Figures 3B through 3H.

Groundwater monitoring wells were installed in borings B-5 and B-8, and pressure transducers were placed in the wells to record future groundwater levels. During the monitoring period (May 26 through July 9, 2020), groundwater was not observed in boring B-5. Groundwater was observed between 31.3 and 32.4 ft bgs in boring B-8. The groundwater observed in boring B-8 is attributed to perched groundwater zones directly above and within the glacial till.

The groundwater conditions reported herein are for the specific locations and dates indicated and may not be indicative of other locations and/or times. Groundwater conditions will vary depending on local subsurface conditions, weather conditions, and other factors. Groundwater levels along the project alignment are expected to fluctuate seasonally, with maximum groundwater levels occurring during late winter and early spring.

---

## 3.0 CONCLUSIONS AND RECOMMENDATIONS

Based on the results of LAI's field investigation and engineering analyses, subsurface conditions along the project alignment are suitable for the proposed improvements, provided the following recommendations are incorporated into the project design.

Cobbles and fractured rock were observed between 7 and 59 ft bgs where the project alignment crosses SR-3. Additionally, the pulverized rock and significant drilling chatter observed in boring B-6 may indicate the presence of large cobbles and/or boulders. If large cobbles and boulders are encountered, the borehole path may need to be realigned to avoid obstructions. The contractor should be prepared to encounter oversized material where glacially derived soils are present along the force main alignment.

Groundwater and groundwater seepage were observed between 1 and 50 ft bgs in nine of the 20 borings completed. Perched groundwater was observed in boring B-8, adjacent to the proposed launch/receptor pit. The contractor should anticipate the need to dewater portions of the project alignment. Where minor groundwater is encountered, conventional sumps and pumps should be sufficient to limit the amount of groundwater that enters the excavations. More significant dewatering efforts may be required if excavations extend below the water table, into areas of highly permeable soil (i.e., Unified Soil Classification System [USCS] soils GP and SP on the summary logs in Appendix A). The contractor should be prepared to manage minor groundwater occurrence and seepage along the force main alignment.

Site soils have a high fines content and are considered moisture sensitive. Earthwork should be avoided during heavy and/or extended periods of precipitation. If moisture conditioning is required, backfilling trenches with excavated site soil may not be practical during the wet season (October through April). All-weather, imported soil may be required for construction performed during the wet season. To achieve compaction requirements, material selected for reuse will need to be moisture conditioned prior to placement. Compaction and moisture control tests should be performed in accordance with Section 2-03.3(14)D of the Washington State Department of Transportation's *2020 Standard Specifications for Road, Bridge, and Municipal Construction (2020 WSDOT Standard Specifications)*.

### 3.1 Earthwork

LAI understands that earthwork activities will include excavating and backfilling trenches to install the replacement pipe. Excavations will likely extend 5 to 10 ft bgs, but may be deeper in the areas near borings B-12 and B-13 where the existing force main is situated more than 10 ft bgs.

Earthwork recommendations, including criteria for the reuse of native site soil as trench backfill, backfill placement and compaction, and shoring and dewatering, are provided in the following

sections. For new utilities installed within public rights-of-way, local standards will supersede the recommendations provided herein.

### **3.1.1 Site Soil**

Granular site soils (i.e., USCS soils GP, SP, GP-GM, and SP-SM) are well suited for reuse as trench backfill; however, constituents greater than 6 inches in diameter should be screened and removed from the soil. In addition, site soils reused as backfill may require moisture conditioning. Compaction and moisture control tests should be performed in accordance with Section 2-03.3(14)D of the *2020 WSDOT Standard Specifications*.

Fine-grained site soils (i.e., USCS soils GM, SM, ML, and CL) are considered moisture sensitive; when moisture-sensitive soils have a water content 2 to 3 percent above or below optimum, compaction requirements may be difficult to achieve. LAI does not recommend reusing fine-grained site soils noted as ML or CL as trench backfill. Soils noted as GM and SM may be suitable for reuse, but could require significant moisture conditioning.

Figures 3B through 3H include cross sections of the soil types observed in LAI's field explorations. The natural moisture contents of select soil samples are shown as  $W = xx$  (i.e., percent of dry weight) on the summary logs in Appendix A. The *in situ* moisture content is representative of dry site conditions; higher moisture contents should be anticipated if construction is completed during the wet season.

#### **3.1.1.1 Utility Trench Excavation and Support**

The majority of the force main replacement will be installed within very loose to very dense or medium stiff to hard glacial deposits. A heavy-duty hydraulic excavator with sufficient reach should be able to excavate trenches to the proposed depths. A smooth-bladed bucket should be used to remove loose and/or disturbed soil from the trench bottom.

The contractor should be responsible for trench configurations and the maintenance of safe working conditions, including temporary excavation stability. All applicable local, state, and federal safety codes should be followed. Temporary excavations for utilities should be no steeper than 1½ horizontal to 1 vertical, based on regulations for safe excavation practice in the State of Washington (Chapter 296-155 of the Washington Administrative Code [WAC]). If groundwater seepage is present, flatter slopes, temporary shoring, and/or dewatering may be required.

Trench boxes should provide adequate support for shallow excavations, provided the trench is properly dewatered, and no settlement-sensitive structures or utilities are located near the excavation. Trench boxes should meet the requirements in Safety Standards for Construction Work, Part N (WAC Chapter 296-155). See Section 3.2 for recommendations to support design of engineered shoring systems.

---

### 3.1.1.2 Pipe Foundation Support

The medium dense to very dense or medium stiff to hard native soil anticipated at the base of utility trenches will provide adequate foundation support for utilities. Before pipe bedding material is placed, the bottom of the trench should be cleared of standing water and compacted to a firm, unyielding condition. Subgrades that consist of dense to very dense, native soil may be suitable for pipe placement without compaction, provided the subgrade remains undisturbed. Trench subgrades should be evaluated by the County or its designated representative(s) before bedding material is placed. Trench subgrades that cannot be compacted to a firm condition, or subgrades that have been disturbed, should be overexcavated and replaced with Class A Foundation Material, per Section 9-03.17 of the *2020 WSDOT Standard Specifications*. Foundation material should be free of roots, topsoil, lumps of silt and clay, and organic and inorganic debris.

### 3.1.1.3 Pipe Bedding and Backfill

Pipe zone bedding should consist of crushed, processed, or naturally occurring granular material, free of organic matter and other deleterious material. Pipe bedding should meet the gradation requirements for Gravel Backfill for Pipe Zone Bedding in Section 9-03.12(3) of the *2020 WSDOT Standard Specifications*.

Pipe bedding should extend at least 6 inches below the invert of the pipe. The bedding material should be compacted to at least 90 percent of its maximum dry density. The initial pipe backfill should be brought up evenly around the pipe in relatively horizontal lifts, not exceeding 6 inches, and worked under the haunches of the pipe by slicing with a shovel, vibration, or other approved procedure. Pipe zone backfill should extend 6 inches above the crown of the pipe. To prevent damage to the pipe, only hand-operated equipment should be used to compact backfill placed directly over the pipe. Material and compaction requirements provided by pipe manufacturers may supersede the recommendations provided herein.

Material selected for trench backfill should conform to the requirements in Section 7-08.3(3) of the *2020 WSDOT Standard Specifications*. Trench backfill should be free of debris, organic material, and rock fragments larger than 6 inches. If wet weather construction is anticipated, the amount of fines should not exceed 5 percent, based on the minus ¾-inch fraction. Gravel Borrow, as described in Section 9-03.14(1) of the *2020 WSDOT Standard Specifications*, is suitable for use as imported fill, with adherence to the requirements set forth in this section.

## 3.1.2 Construction Dewatering

Groundwater was observed in LAI's May 2020 explorations. The majority of groundwater was observed between 8 and 25 ft bgs; groundwater was observed between 30 and 50 ft bgs where the project alignment crosses SR-3. Slow groundwater seepage was observed at approximately 1 ft bgs in boring HA-11. Localized zones of shallow, perched groundwater may be encountered along the project alignment. Figures 3B through 3H indicate the locations where groundwater was observed.

Most excavations (10 ft bgs or shallower) are expected to terminate above the water table; however, construction dewatering may be required along portions of the project alignment. Where minor amounts of groundwater seepage are encountered, conventional sumps and pumps should be sufficient to limit the amount of groundwater that enters excavations. Between May 26 and July 9, 2020, the monitoring wells installed in borings B-5 and B-8 were used to record groundwater levels at the proposed HDD launch and receptor shaft locations. During the monitoring period, groundwater was observed at approximately 32 ft bgs in boring B-8. The monitoring well in boring B-8 is installed at the surface elevation of the SR-3 off-ramp, and the groundwater levels observed are anticipated to be within the proposed launch/receptor shaft excavation at the base of the embankment adjacent to boring B-8. The launch/receptor shaft excavations are not expected to require significant dewatering (e.g., use of well points, deep wells), provided the excavations do not extend more than 20 ft bgs.

However, soils along portions of the project alignment are granular and readily transmit groundwater. If excavations will extend below the water table, conventional sumps and pumps may not be adequate to provide a dry, stable work area. The use of multiple trash pumps or cutoff walls may be required. Completing construction during the summer and early fall will reduce dewatering needs along the project alignment. The contractor should be responsible for the design, permitting, installation, monitoring, and maintenance of dewatering system(s).

### 3.2 Temporary Shoring

Granular soils should be shored or sloped to maintain excavation stability. A rigid trench box or steel sheets, spanned with expandable hydraulic jacks, could be used to shore portions of trenches excavated beneath roadways. These shoring methods could cause ground deformation and pavement cracking near the excavations. The contractor should be responsible for excavation safety and stability; excavations should conform to the requirements in Chapter 296-155 of the WAC.

The temporary shoring system should be designed by a civil or structural engineer licensed in the State of Washington. The shoring system should support lateral loads exerted by the retained soil mass and hydrostatic pressure, as described in Table 1. The shoring design should account for surcharge loads from construction equipment and materials and from excavated, stockpiled soil. Prior to implementation, the design should be submitted for the County's review and approval.

**Table 1. Recommended Soil Parameters for Design of Temporary Shoring**

Soil Unit	Moist Unit Weight (pcf)	Submerged Unit Weight (pcf)	Cohesion (psf)	Internal Angle of Friction (degrees)
Fill	130	58	0	32
Ice-contact Deposits	130	68	0	34
Recessional Outwash	120	58	0	30
Pre-Vashon Silt	115	53	0	30

Soil Unit	Moist Unit Weight (pcf)	Submerged Unit Weight (pcf)	Cohesion (psf)	Internal Angle of Friction (degrees)
Glacial Till	130	73	0	36

pcf = pounds per cubic foot

psf = pounds per square foot

### 3.3 Trenchless Installation

The following sections include LAI's geotechnical recommendations for trenchless construction techniques.

#### 3.3.1 Horizontal Directional Drilling

HDD may be used to replace the portion of sewer main that crosses beneath SR-3. Based on the conditions observed in LAI's May 2020 explorations, HDD generally is considered an acceptable technique for installing the replacement pipe.

The glacial till observed in LAI's explorations contains cobbles and possibly boulders that could create difficult drilling conditions. Cobbles and boulders could impede pilot bore installation and could become lodged in the bit and/or reamer during back reaming. Additionally, cobbles in the sidewalls of the borehole tend to fall into the hole and are difficult to remove. The design team should review the proposed borehole path and evaluate the potential difficulties of drilling through a geologic unit that contains cobbles and/or boulders (i.e., glacial till). Additionally, the proposed borehole path will be at least 550 ft long, given the width of SR-3 at the HDD crossing. The likelihood of encountering obstructions and/or soil collapse will increase with the length of the boreholes. LAI recommends that a specialty trenchless consulting firm or contractor be consulted to assess site risks and to confirm the feasibility of using HDD to install pipe beneath SR-3.

Soil conditions along the proposed HDD alignment are expected to consist of dense to very dense fill or glacial till. No indications of artesian groundwater conditions were observed at the locations explored; however, soil heave, which may be indicative of pressurized aquifers, was observed in boring B-8. During final design, the design team should consider the impacts soil heave could have on the proposed HDD.

Scattered cobbles, approximately 3 inches in diameter and larger, were observed along the proposed HDD alignment. Cobbles and fractured rock (material presumably fractured by the split-spoon sampler) were observed intermittently from 7 to 59 ft bgs. The pulverized rock and significant drilling chatter observed in boring B-6 may indicate the presence of large cobbles and/or boulders. If encountered, large cobbles and boulders could obstruct the HDD. If drilling refusal occurs during trenchless construction, the contractor should confirm the alignment of the borehole path with the design team, then back up the drill steel and attempt to steer around the obstruction(s).



During trenchless construction, gravel may collect along the low point of the borehole path; the gravel could obstruct pullback, if not flushed from the borehole. In LAI’s experience, a likely construction sequence will include setting up the drill rig at the launch location; drilling a 6- to 9-inch-diameter pilot hole; pushing or back-reaming the hole to a uniform diameter, slightly greater than the diameter of the new sewer pipe; connecting to the new pipe; and pulling the pipe into place. Nearby structures and the geometry of the borehole path could limit the space available for laying out HDPE pipe. If space is limited, a locking-joint polyvinyl chloride pipe (e.g., Certa-Lok®) could be inserted, cartridge-style.

The contractor should be responsible for the containment of all drilling fluids. LAI recommends excavating a catchment pit at the downhill end of the HDD alignment. In addition, the borehole path should include adequate soil cover to prevent ground heave and “frac-out” (inadvertent release of drilling fluid at the ground surface). The annular space around the completed pipe ends should be sealed with cement grout to prevent unintended drainage. LAI recommends sealing at least 25 ft at each end of the pipe.

The recommended soil engineering properties in Table 2 can be used to support HDD design. Actual soil properties may differ from those presented below.

**Table 2. Recommended Soil Engineering Properties**

Soil Unit	Moist Unit Weight (pcf)	Drained Angle of Internal Friction (degrees)	Drained Cohesion (C; psf)	Shear Modulus (G; kips/ft <sup>2</sup> )
Fill	120–130	34	0–50	220–430
Glacial Till	125–135	38	300–500	740–1,200

ft<sup>2</sup> = square feet

pcf = pounds per cubic foot

psf = pounds per square foot

### 3.3.2 Pipe Jacking and Microtunneling

Pipe jacking and microtunneling are alternative trenchless construction techniques that can be used with oversized material (cobbles and boulders) that may impede HDD. Pipe jacking and microtunneling rely on a horizontal jacking force to advance a shield (pipe jacking) or tunnel-boring machine. Both methods support the borehole as the pipe is advanced during excavation.

With pipe jacking, personnel must enter the pipe; a minimum pipe diameter of 48 inches is required to accommodate entry. Pipes installed via microtunneling can be as small as 10 inches in diameter, as entry is not required. Pipe jacking can be used to tunnel through particles that are 95 percent the size of the casing diameter, and microtunneling can be used to tunnel through particles that are 33 percent the size of the casing diameter. Both methods can achieve the proposed 550-ft borehole length. Compared to HDD, pipe jacking and microtunneling are considered cost prohibitive; however, these methods merit consideration, as they do not carry the risk of obstruction or soil collapse.

### **3.3.3 Auger Boring**

Auger boring, often referred to as “jack and bore,” is an alternative trenchless technique capable of tunneling through material up to 33 percent the size of the casing diameter. This method includes a cutter head that is advanced in combination with the casing pipe to support the borehole. During advancement of the casing, helical auger flights are used to remove spoils from the casing. The auger boring technique is feasible for the anticipated soil conditions; however, a maximum borehole length of 500 ft typically is recommended for this method. An intermediate drive/receptor shaft is not considered feasible, given the proximity to SR-3. In addition, the auger boring technique should not be used below the groundwater table, in running sands, or in soils that contain large boulders. Once launched, auger boring typically is unguided, and subsurface obstructions (such as boulders) can cause large deflections.

---

## **4.0 CONSTRUCTION SUPPORT**

LAI recommends that a geotechnical engineer, familiar with the site, review the plans and specifications for compliance with the recommendations in this report. LAI also recommends that geotechnical monitoring, testing, and consultation are provided during construction to confirm that site subsurface conditions are consistent with those observed in the field explorations; to provide updated recommendations should conditions differ from those anticipated; and to evaluate whether geotechnical construction activities comply with project plans, specifications, and the recommendations contained in this report. Geotechnical construction activities include preparation of utility subgrade, placement and compaction of backfill material, and other earthwork activities. LAI would be pleased to provide these services for you.

## **5.0 USE OF THIS REPORT**

Landau Associates, Inc. (LAI) has prepared this report for the exclusive use of Murraysmith, Inc. and its designated representatives for specific application to the Bangor-Keyport Force Main Replacement project in Kitsap County, Washington. No other party is entitled to rely on the information, conclusions, and recommendations included in this document without the express written consent of LAI. Reuse of the information, conclusions, and recommendations provided herein for extensions of the project or for any other project, without review and authorization by LAI, shall be at the user's sole risk. LAI warrants that, within the limitations of scope, schedule, and budget, its services have been provided in a manner consistent with that level of skill and care ordinarily exercised by members of the profession currently practicing in the same locality under similar conditions as this project. LAI makes no other warranty, either express or implied.

## 6.0 REFERENCES

ASTM. 2017. Annual Book of ASTM Standards. In: *Soil and Rock (I)*. West Conshohocken, PA: ASTM International.

Murraysmith. 2019. Draft Engineering Analysis Report: Sewer Pipeline Corrosion Analysis, Kitsap County. September.

Polenz, M., G.T. Petro, T.A. Contreras, K.A. Stone, G.L. Paulin, and R. Cakir. 2013. *Geologic Map of the Seabeck and Poulsbo 7.5-minute Quadrangles, Kitsap and Jefferson Counties, Washington*. Map Series 2013-02. Washington Division of Geology and Earth Resources.

Washington State Department of Labor and Industries. 2016. Construction Work. Chapter 296-155 WAC; Part N. Excavation, Trenching, and Shoring. May 20.

WSDOT. 2019. M41-10: Standard Specifications for Road, Bridge, and Municipal Construction. 2020 Edition. Washington State Department of Transportation. September 1.



G:\Projects\1490\005\010\013\F01VicMap.mxd 7/19/2020

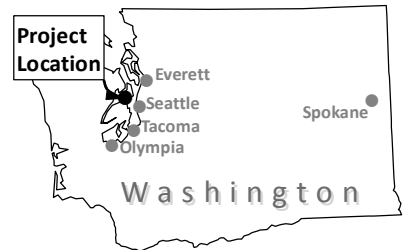
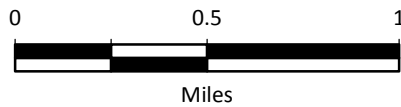

Data Source: Esri 2012



Bangor-Keyport  
Force Main Replacement  
Kitsap County, Washington

**Vicinity Map**

Figure  
**1**

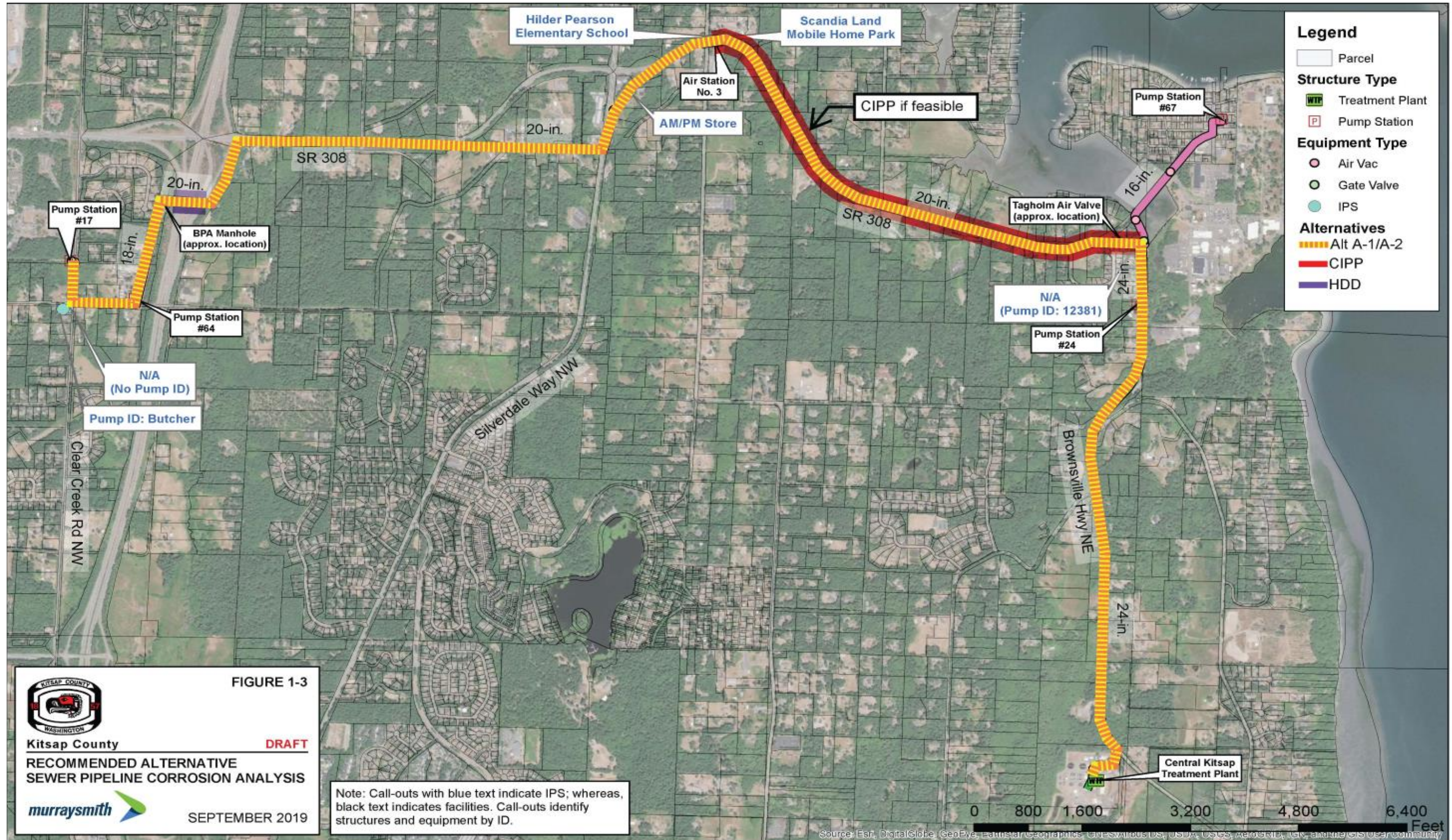

**FIGURE 1-3**  
**Kitsap County**  
**RECOMMENDED ALTERNATIVE**  
**SEWER PIPELINE CORROSION ANALYSIS**  
**DRAFT**  
 SEPTEMBER 2019

Note: Call-outs with blue text indicate IPS; whereas, black text indicates facilities. Call-outs identify structures and equipment by ID.

18-2316  
 September 2019

Page 1-9  
 Executive Summary

Source: Murraysmith, 2019

Kitsap County  
 Sewer Pipeline Corrosion Analysis

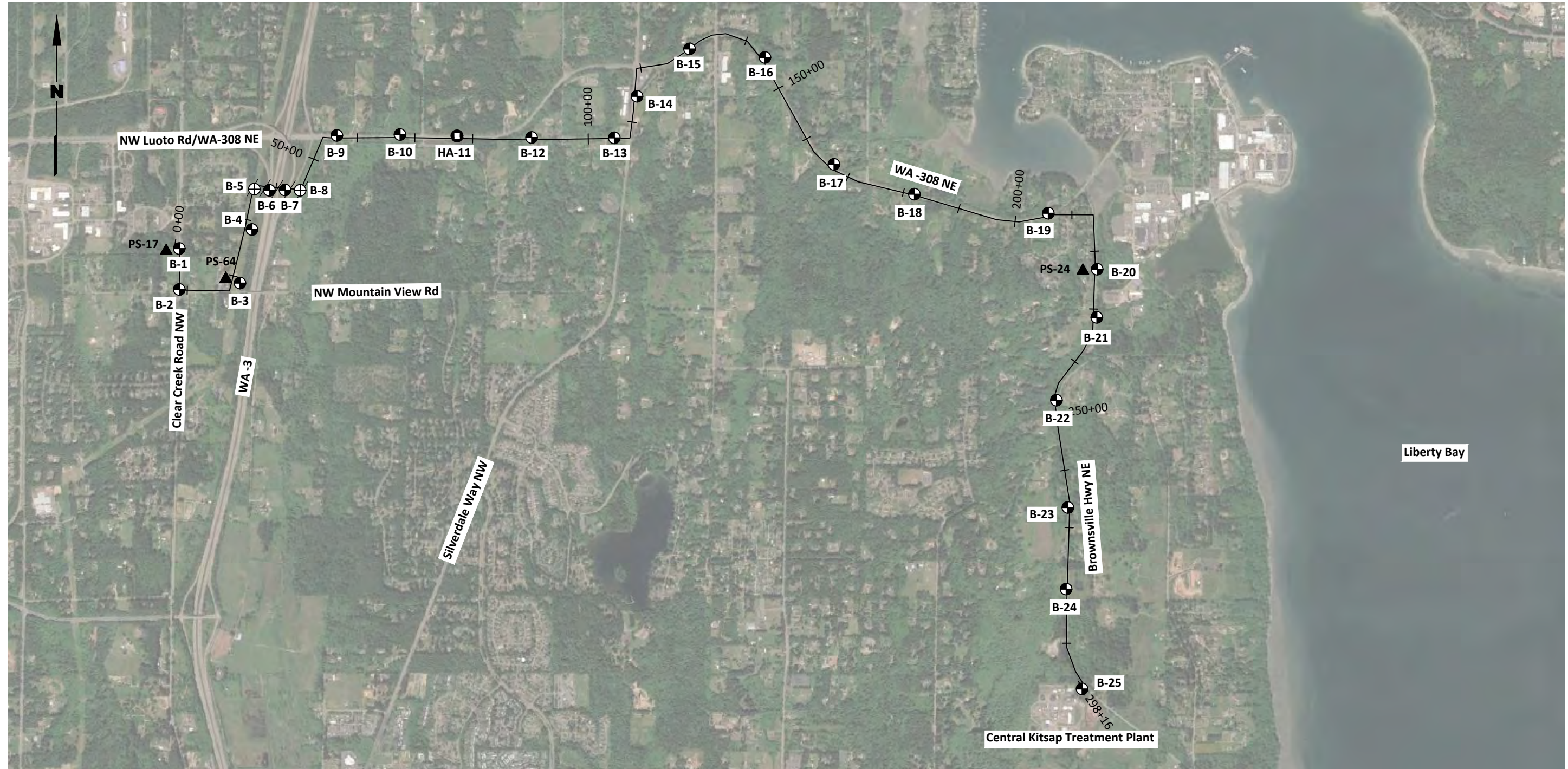

Landau Associates | Y:\CAD\1490\005.010\Summary Plan.dwg | 7/22/2020 12:30 PM | caduser

**Legend**

- B-1 Approximate Boring Location and Designation
- B-6 Approximate Monitoring Well Location and Designation
- HA-11 Approximate Hand Auger Location and Designation
- PS-1 Pump Station Location
- Proposed Horizontal Directional Drilling Alignment

**Note**

1. Black and white reproduction of this color original may reduce its effectiveness and lead to incorrect interpretation.

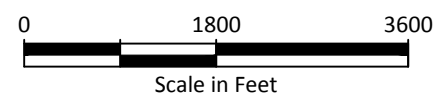

Source: Google Earth 2020

Bangor-Keyport Force Main Replacement Kitsap County, Washington	<b>Summary Site and Exploration Plan</b>	<b>Figure 3A</b>
-----------------------------------------------------------------------	------------------------------------------	----------------------



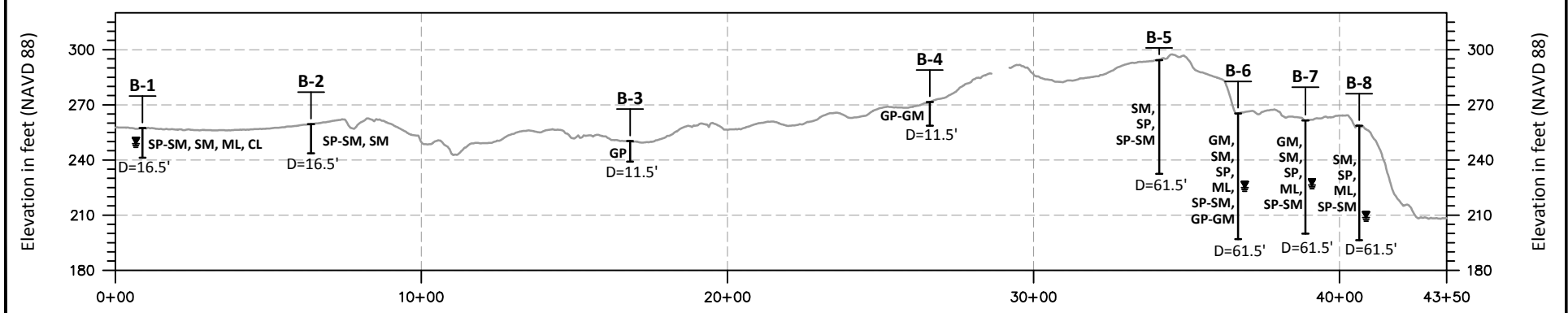
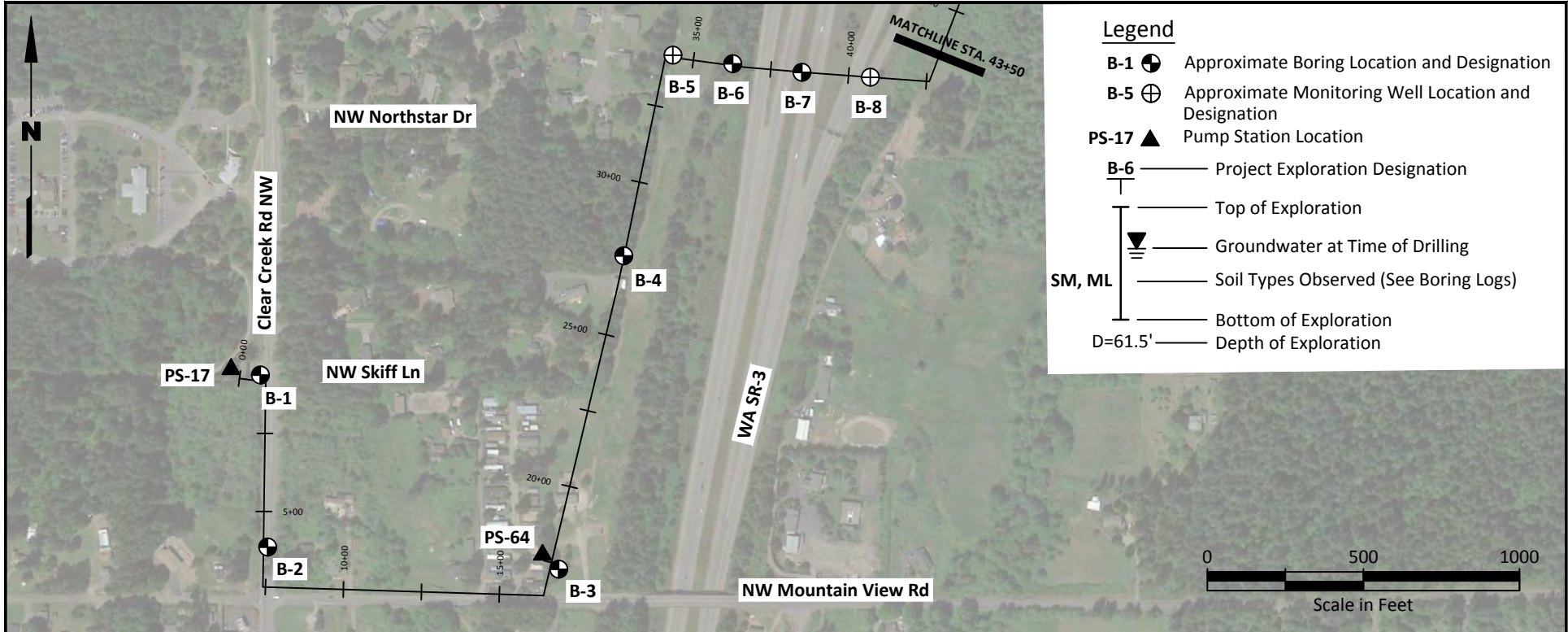

**Note**

1. Black and white reproduction of this color original may reduce its effectiveness and lead to incorrect interpretation.
2. NAVD 88 - North American Vertical Datum of 1988

Source: Google Earth 2020; Puget Sound LIDAR Consortium 2020



Bangor-Keyport  
Force Main Replacement  
Kitsap County, Washington

**Site and Exploration Plan B  
and Geologic Cross Section**

**Figure  
3B**

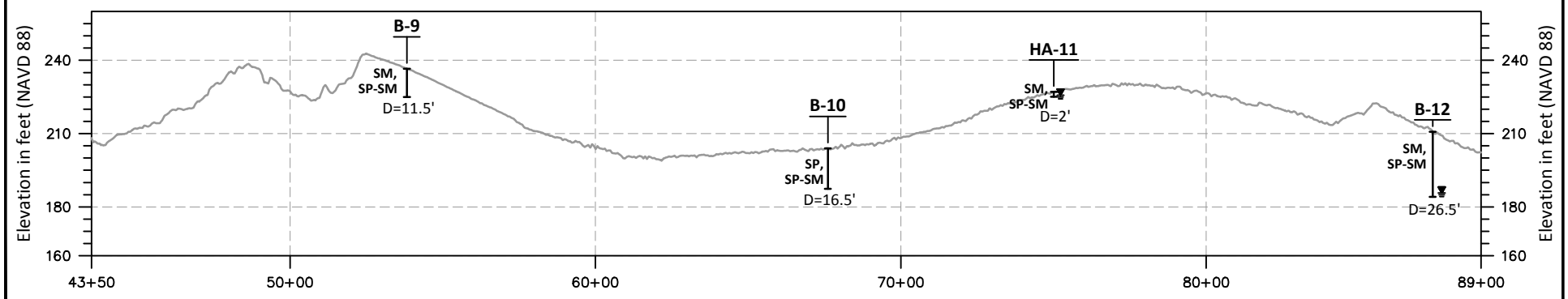
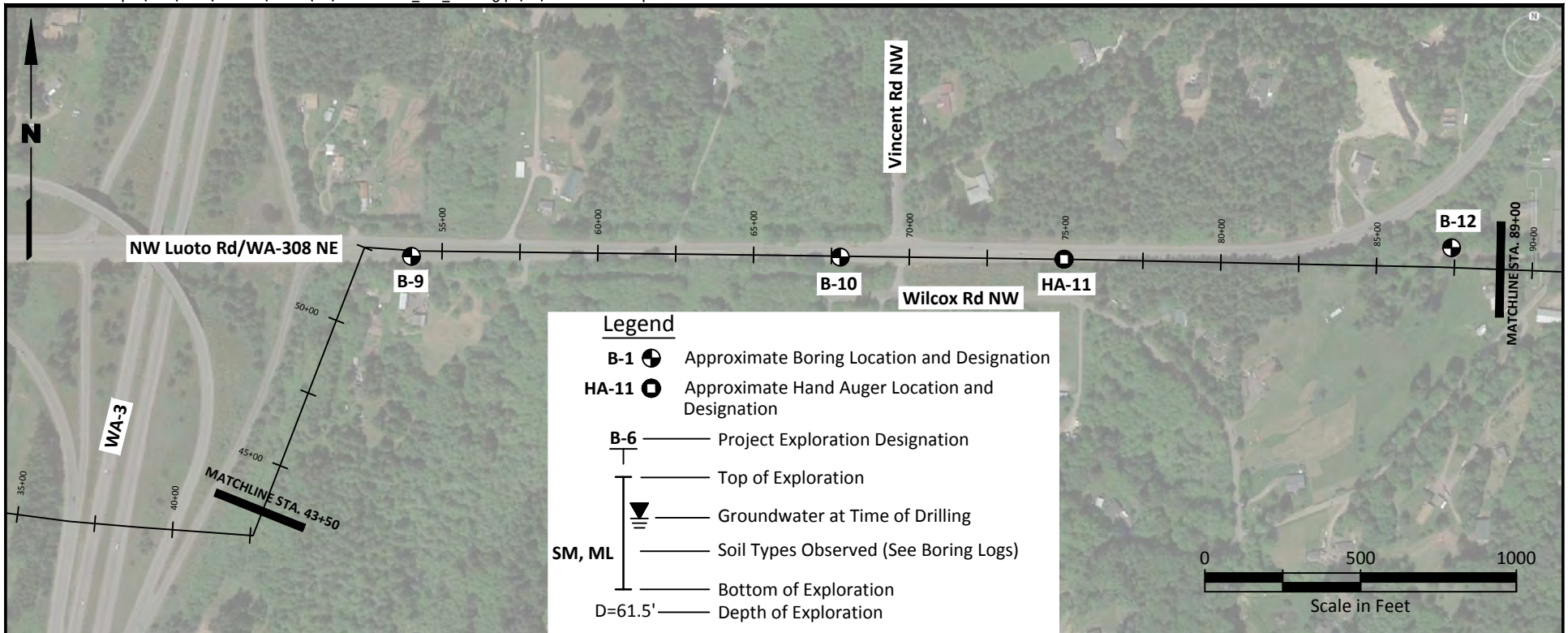

**Note**

1. Black and white reproduction of this color original may reduce its effectiveness and lead to incorrect interpretation.
2. NAVD 88 - North American Vertical Datum of 1988

Source: Google Earth 2020; Puget Sound LIDAR Consortium 2020



<p>Bangor-Keyport Force Main Replacement Kitsap County, Washington</p>	<p><b>Site and Exploration Plan C and Geologic Cross Section</b></p>	<p>Figure <b>3C</b></p>
--------------------------------------------------------------------------------	--------------------------------------------------------------------------	-----------------------------

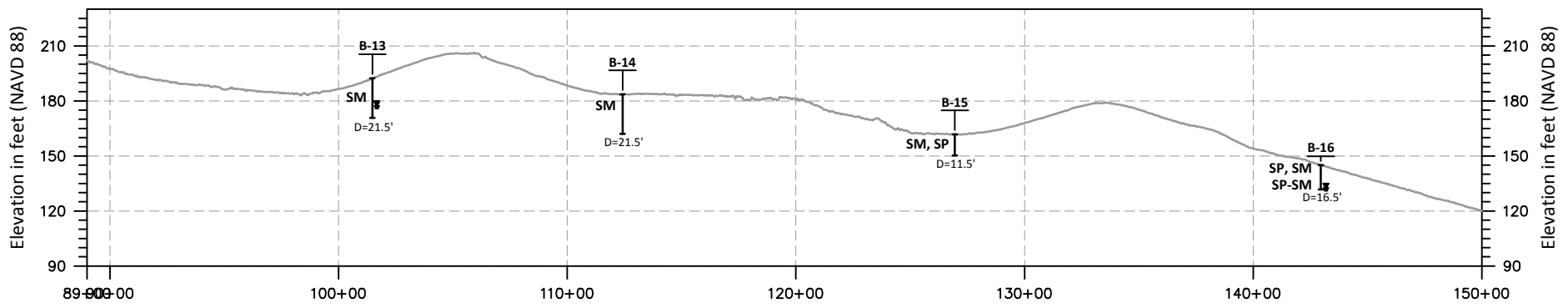
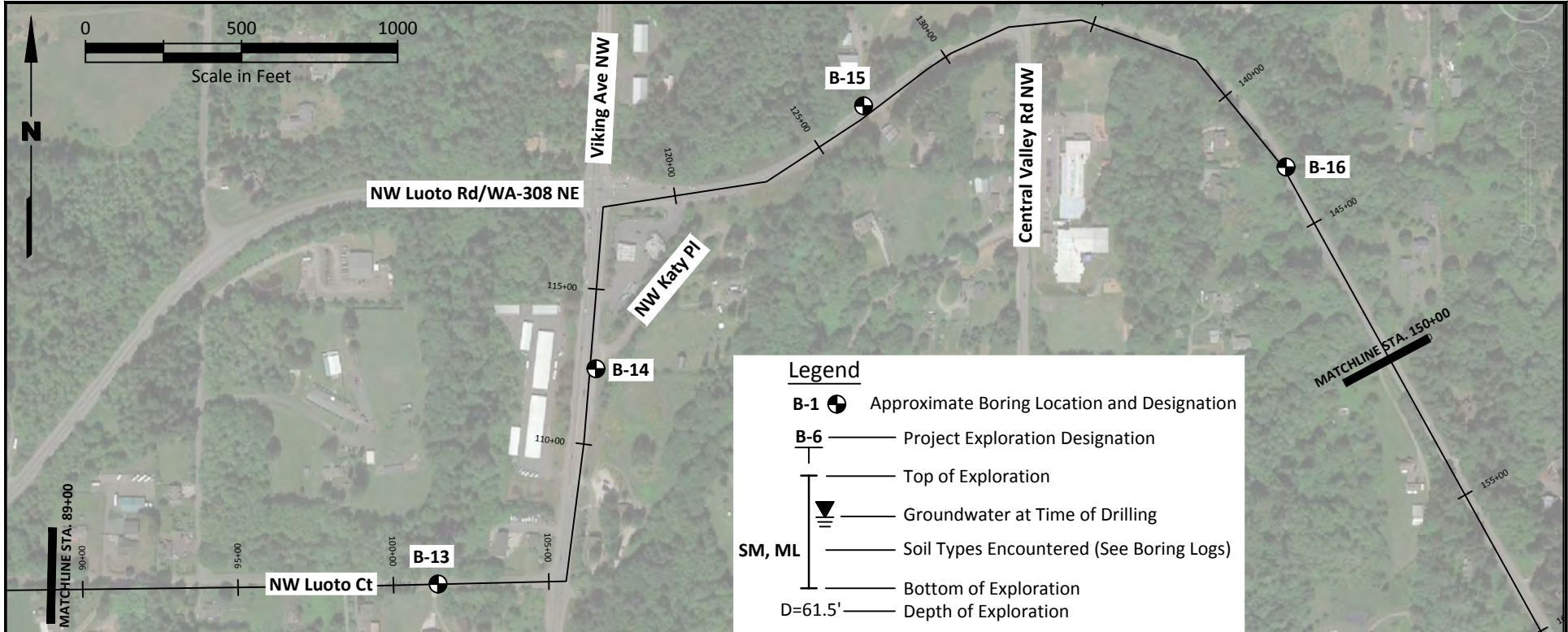

- Note**
1. Black and white reproduction of this color original may reduce its effectiveness and lead to incorrect interpretation.
  2. NAVD 88 - North American Vertical Datum of 1988

Source: Google Earth 2020; Puget Sound LIDAR Consortium 2020



Bangor-Keyport  
Force Main Replacement  
Kitsap County, Washington

**Site and Exploration Plan D  
and Geologic Cross Section**

**Figure  
3D**

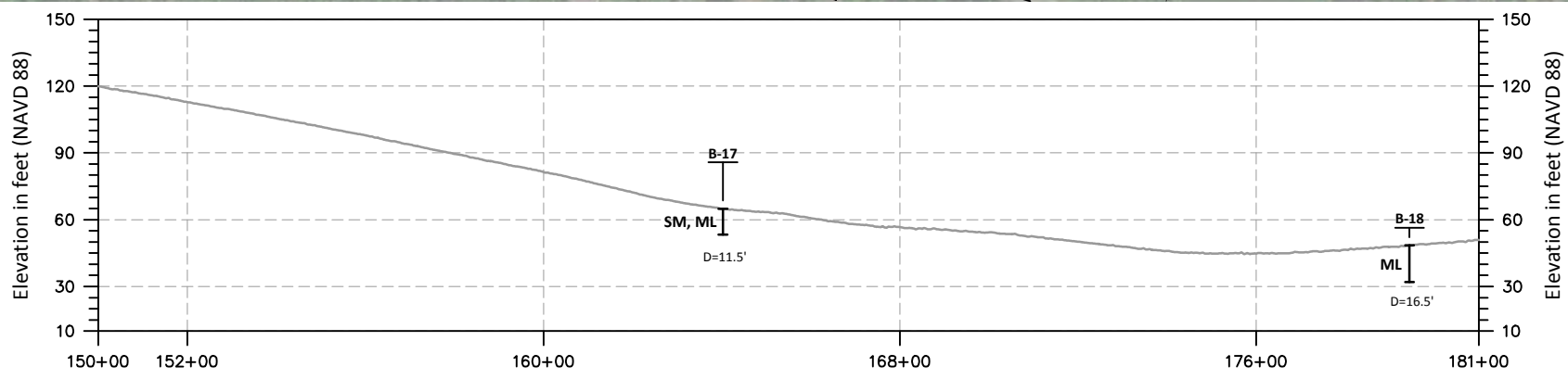
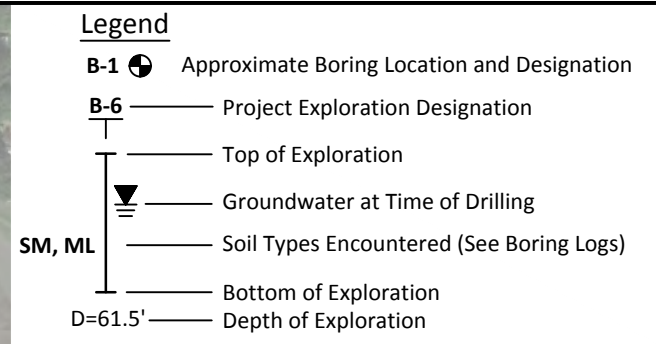
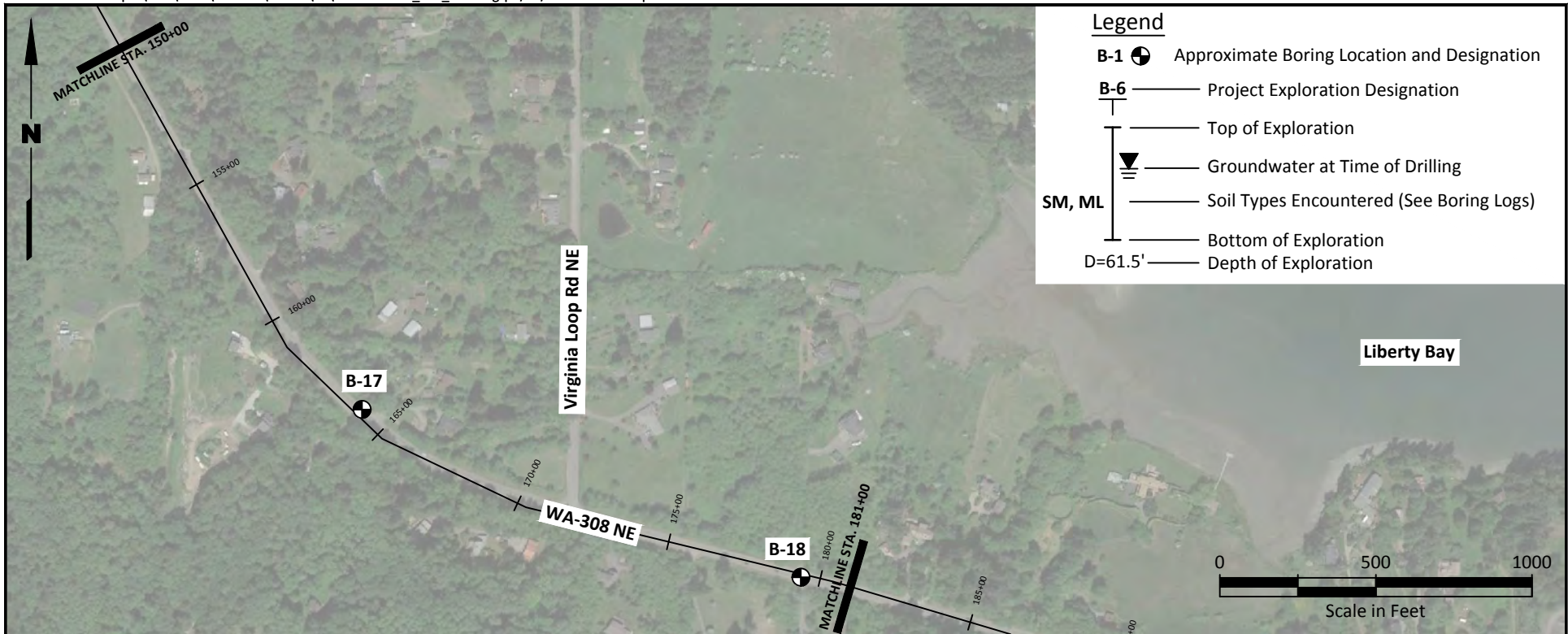

**Note**

1. Black and white reproduction of this color original may reduce its effectiveness and lead to incorrect interpretation.
2. NAVD 88 - North American Vertical Datum of 1988

Source: Google Earth 2020; Puget Sound LIDAR Consortium 2020



Bangor-Keyport  
Force Main Replacement  
Kitsap County, Washington

**Site and Exploration Plan E  
and Geologic Cross Section**

**Figure  
3E**

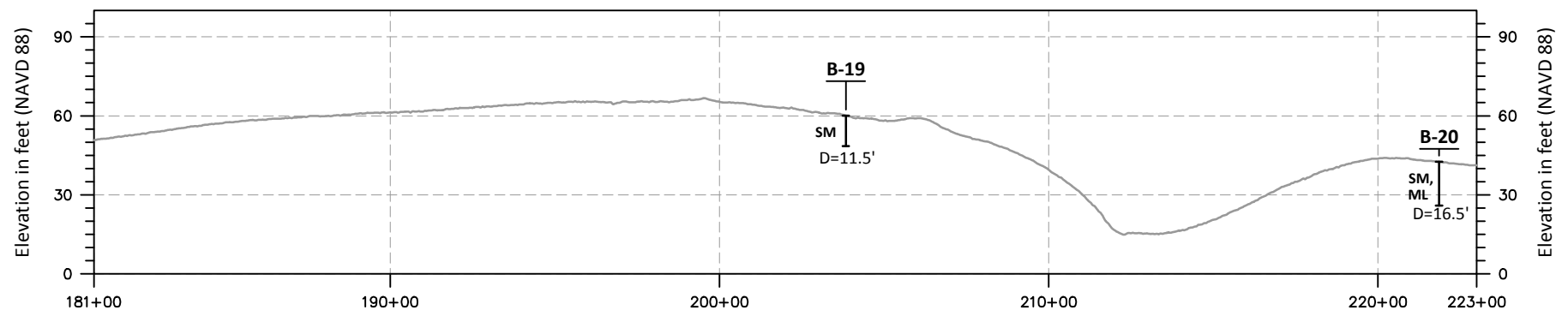
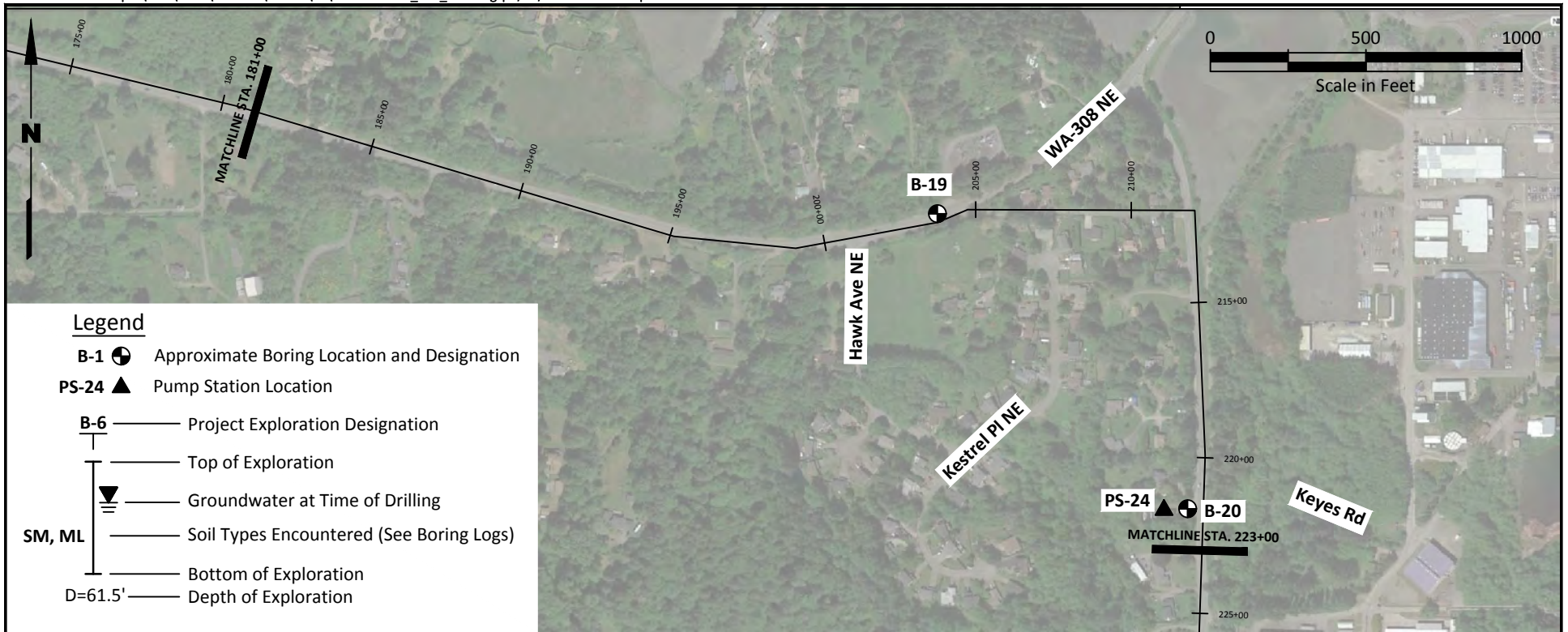

**Note**

1. Black and white reproduction of this color original may reduce its effectiveness and lead to incorrect interpretation.
2. NAVD 88 - North American Vertical Datum of 1988

Source: Google Earth 2020; Puget Sound LIDAR Consortium



Bangor-Keyport  
Force Main Replacement  
Kitsap County, Washington

**Site and Exploration Plan F  
and Geologic Cross Section**

**Figure  
3F**

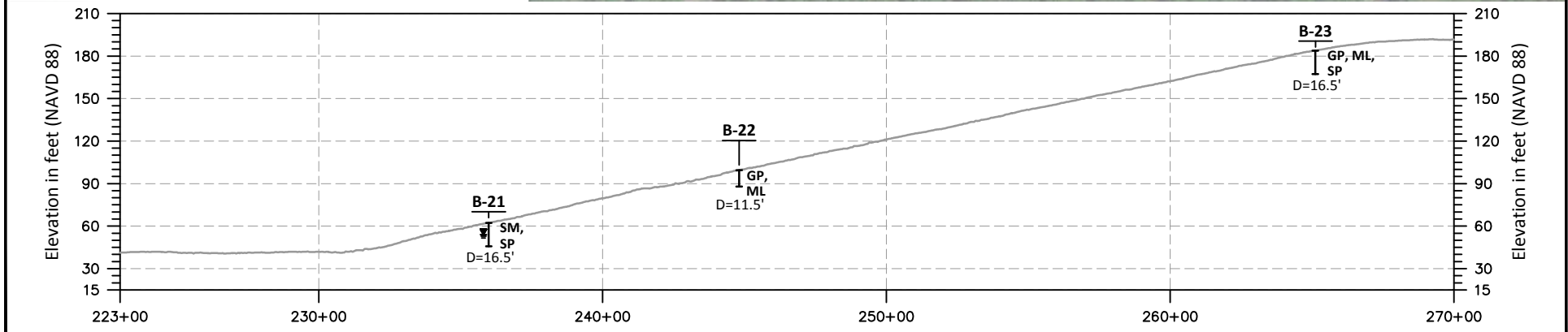
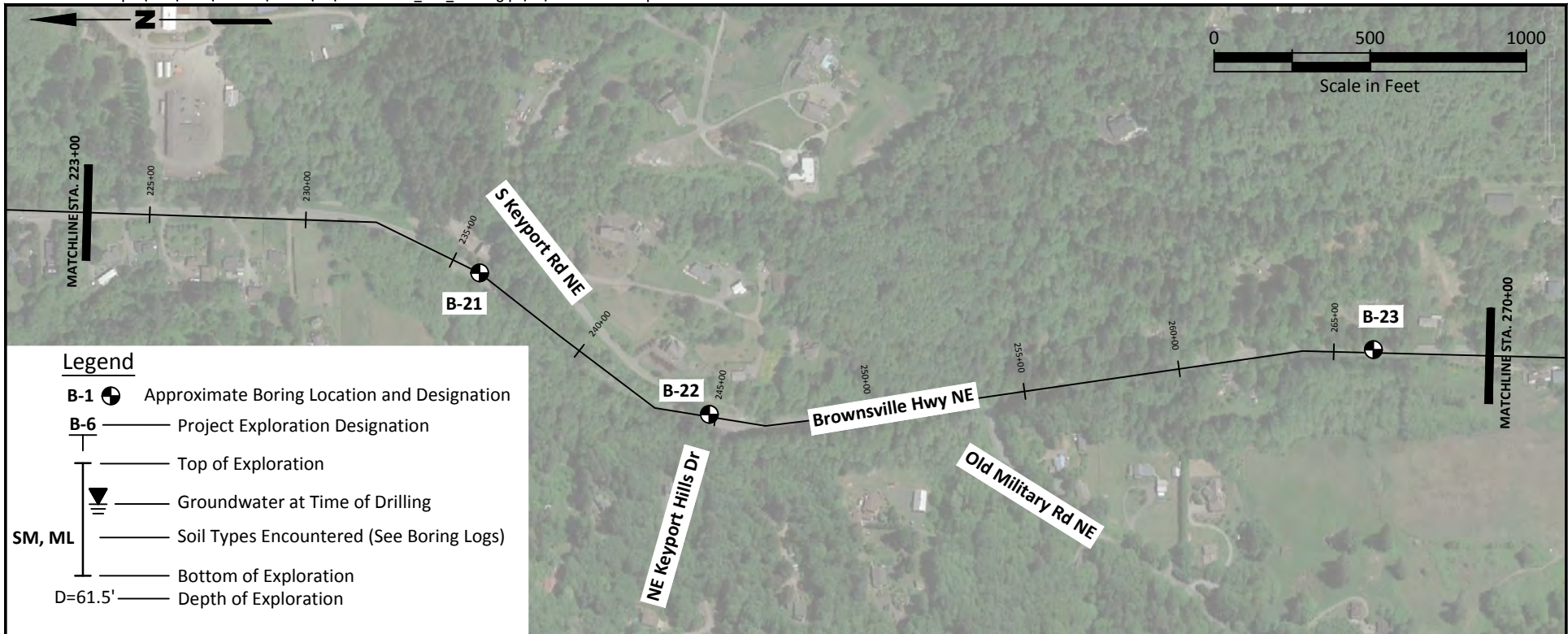

**Note**

1. Black and white reproduction of this color original may reduce its effectiveness and lead to incorrect interpretation.
2. NAVD 88 - North American Vertical Datum of 1988

Source: Google Earth 2020; Puget Sound LIDAR Consortium 2020



Bangor-Keyport  
Force Main Replacement  
Kitsap County, Washington

**Site and Exploration Plan G  
and Geologic Cross Section**

**Figure  
3G**

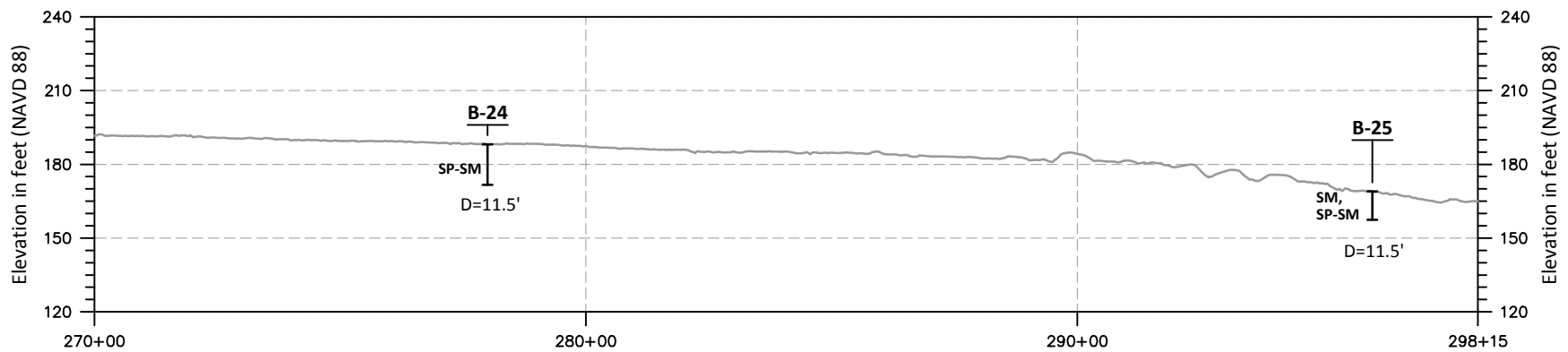
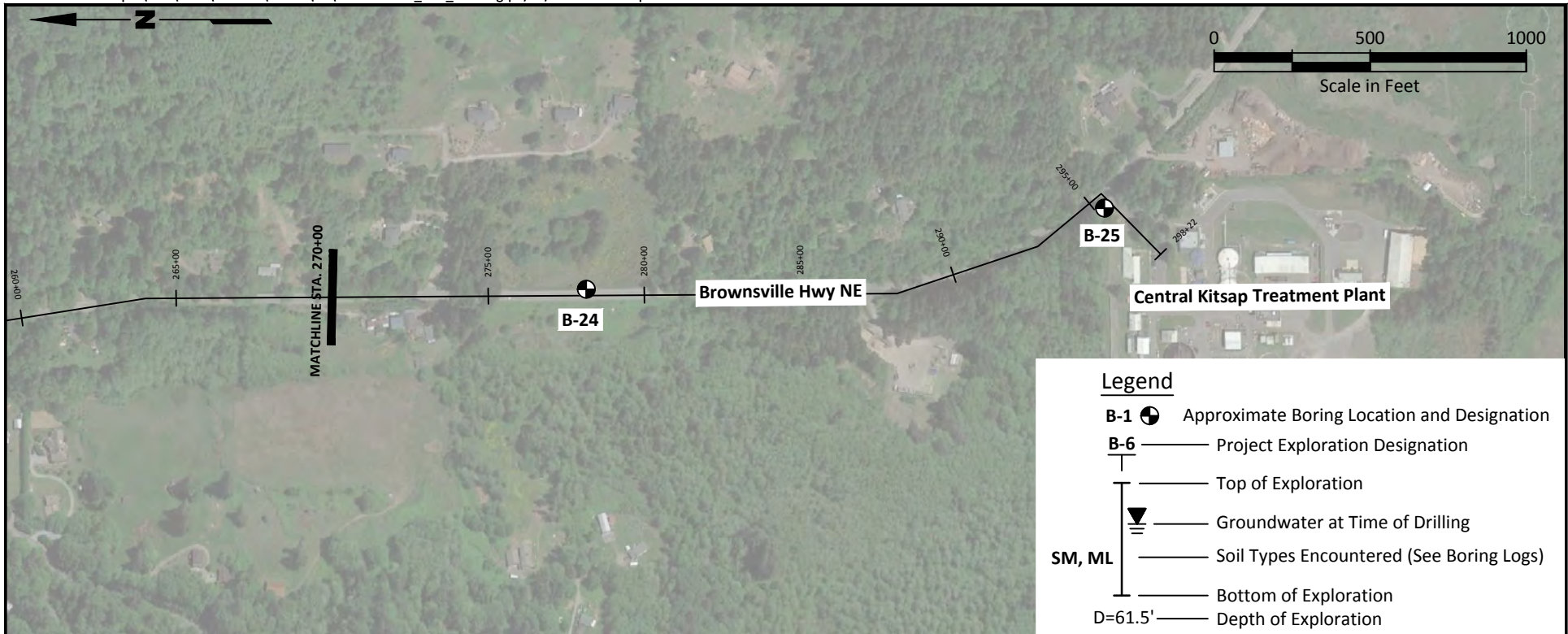

**Note**

1. Black and white reproduction of this color original may reduce its effectiveness and lead to incorrect interpretation.
2. NAVD 88 - North American Vertical Datum of 1988

Source: Google Earth 2020; Puget Sound LIDAR Consortium



Bangor-Keyport  
Force Main Replacement  
Kitsap County, Washington

**Site and Exploration Plan H  
and Geologic Cross Section**

**Figure  
3H**

# Field Explorations



## **APPENDIX A FIELD EXPLORATIONS**

Site subsurface conditions were explored in May 2020 by advancing 20 hollow-stem auger borings 16.5 to 26.5 feet (ft) below ground surface (bgs), four Rotosonic™ borings 60.0 to 61.5 ft bgs, and one hand-auger boring 2.0 ft bgs. Holocene Drilling, Inc., subcontracted by Landau Associates, Inc. (LAI), advanced the hollow-stem auger and Rotosonic borings. An LAI representative advanced the hand-auger boring.

The field exploration program was coordinated and monitored by LAI personnel, who also obtained representative soil samples, maintained a detailed record of the subsurface soil and groundwater conditions observed, and described the soil encountered by visual and textural examination. Each representative soil type was described using the soil classification system shown on Figure A-1, in general accordance with ASTM International standard test method D2488, *Standard Practice for Description and Identification of Soils (Visual-Manual Procedures)*.

Summary boring logs are presented on Figures A-2 through A-26. The stratigraphic contacts shown on the logs represent the approximate boundaries between soil types; actual transitions may be more gradual. The soil and groundwater conditions depicted are for the specific dates and locations indicated and may not be representative of other locations and/or times.

Disturbed and undisturbed soil samples were obtained from the hollow-stem auger and Rotosonic borings at 2.5- or 5-ft intervals. Disturbed samples were collected using a 1.5-inch-inside-diameter, standard penetration test, split-spoon sampler. A 140-pound automatic hammer, falling a distance of approximately 30 inches, was used to drive the sampler 18 inches (or a portion thereof) into the undisturbed soil. The number of blows required to drive the sampler the final 12 inches (or a portion thereof) of soil penetration is noted on the boring logs. Upon completion of drilling and sampling, the hollow-stem auger and Rotosonic boreholes were decommissioned in general accordance with the requirements in Washington Administrative Code 173-160. The hand-auger boring was backfilled with excavated soil.

Samples were transported to LAI's soils laboratory for further examination and testing. Test results and a discussion of the testing procedures are presented in Appendix B.

## Soil Classification System

	MAJOR DIVISIONS	CLEAN GRAVEL (Little or no fines)	GRAPHIC SYMBOL	USCS LETTER SYMBOL <sup>(1)</sup>	TYPICAL DESCRIPTIONS <sup>(2)(3)</sup>	
COARSE-GRAINED SOIL (More than 50% of material is larger than No. 200 sieve size)	GRAVEL AND GRAVELLY SOIL  (More than 50% of coarse fraction retained on No. 4 sieve)	CLEAN GRAVEL (Little or no fines)		<b>GW</b>	Well-graded gravel; gravel/sand mixture(s); little or no fines	
		GRAVEL WITH FINES (Appreciable amount of fines)		<b>GP</b>	Poorly graded gravel; gravel/sand mixture(s); little or no fines	
	SAND AND SANDY SOIL  (More than 50% of coarse fraction passed through No. 4 sieve)	CLEAN SAND (Little or no fines)	CLEAN SAND (Little or no fines)		<b>SW</b>	Well-graded sand; gravelly sand; little or no fines
			Poorly graded sand; gravelly sand; little or no fines		<b>SP</b>	Poorly graded sand; gravelly sand; little or no fines
		SAND WITH FINES (Appreciable amount of fines)	Silty sand; sand/silt mixture(s)		<b>SM</b>	Silty sand; sand/silt mixture(s)
			Clayey sand; sand/clay mixture(s)		<b>SC</b>	Clayey sand; sand/clay mixture(s)
FINE-GRAINED SOIL (More than 50% of material is smaller than No. 200 sieve size)	SILT AND CLAY  (Liquid limit less than 50)	Inorganic silt and very fine sand; rock flour; silty or clayey fine sand or clayey silt with slight plasticity		<b>ML</b>	Inorganic silt and very fine sand; rock flour; silty or clayey fine sand or clayey silt with slight plasticity	
		Inorganic clay of low to medium plasticity; gravelly clay; sandy clay; silty clay; lean clay		<b>CL</b>	Inorganic clay of low to medium plasticity; gravelly clay; sandy clay; silty clay; lean clay	
		Organic silt; organic, silty clay of low plasticity		<b>OL</b>	Organic silt; organic, silty clay of low plasticity	
	SILT AND CLAY  (Liquid limit greater than 50)	Inorganic silt; micaceous or diatomaceous fine sand		<b>MH</b>	Inorganic silt; micaceous or diatomaceous fine sand	
		Inorganic clay of high plasticity; fat clay		<b>CH</b>	Inorganic clay of high plasticity; fat clay	
		Organic clay of medium to high plasticity; organic silt		<b>OH</b>	Organic clay of medium to high plasticity; organic silt	
	HIGHLY ORGANIC SOIL	Peat; humus; swamp soil with high organic content		<b>PT</b>	Peat; humus; swamp soil with high organic content	

OTHER MATERIALS	GRAPHIC SYMBOL	LETTER SYMBOL	TYPICAL DESCRIPTIONS
PAVEMENT		<b>AC or PC</b>	Asphalt concrete pavement or Portland cement pavement
ROCK		<b>RK</b>	Rock (See Rock Classification)
WOOD		<b>WD</b>	Wood, lumber, wood chips
DEBRIS		<b>DB</b>	Construction debris, garbage

- Notes:
- USCS letter symbols correspond to symbols used by the Unified Soil Classification System and ASTM classification methods. Dual letter symbols (e.g., SP-SM for sand or gravel) indicate soil with an estimated 5-15% fines. Multiple letter symbols (e.g., ML/CL) indicate borderline or multiple soil classifications.
  - Soil descriptions are based on the general approach presented in the Standard Practice for Description and Identification of Soils (Visual-Manual Procedure), outlined in ASTM D 2488. Where laboratory index testing has been conducted, soil classifications are based on the Standard Test Method for Classification of Soils for Engineering Purposes, as outlined in ASTM D 2487.
  - Soil description terminology is based on visual estimates (in the absence of laboratory test data) of the percentages of each soil type and is defined as follows:
    - Primary Constituent: > 50% - "GRAVEL," "SAND," "SILT," "CLAY," etc.
    - Secondary Constituents: > 30% and ≤ 50% - "very gravelly," "very sandy," "very silty," etc.
    - > 15% and ≤ 30% - "gravelly," "sandy," "silty," etc.
    - Additional Constituents: > 5% and ≤ 15% - "with gravel," "with sand," "with silt," etc.
    - ≤ 5% - "with trace gravel," "with trace sand," "with trace silt," etc., or not noted.
  - Soil density or consistency descriptions are based on judgement using a combination of sampler penetration blow counts, drilling or excavating conditions, field tests, and laboratory tests, as appropriate.

Drilling and Sampling Key		Field and Lab Test Data																																																				
SAMPLER TYPE	SAMPLE NUMBER & INTERVAL																																																					
<table style="width: 100%; border-collapse: collapse;"> <tr> <th style="width: 10%;">Code</th> <th>Description</th> </tr> <tr><td>a</td><td>3.25-inch O.D., 2.42-inch I.D. Split Spoon</td></tr> <tr><td>b</td><td>2.00-inch O.D., 1.50-inch I.D. Split Spoon</td></tr> <tr><td>c</td><td>Shelby Tube</td></tr> <tr><td>d</td><td>Grab Sample</td></tr> <tr><td>e</td><td>Single-Tube Core Barrel</td></tr> <tr><td>f</td><td>Double-Tube Core Barrel</td></tr> <tr><td>g</td><td>2.50-inch O.D., 2.00-inch I.D. WSDOT</td></tr> <tr><td>h</td><td>3.00-inch O.D., 2.375-inch I.D. Mod. California</td></tr> <tr><td>i</td><td>Other - See text if applicable</td></tr> <tr><td>1</td><td>300-lb Hammer, 30-inch Drop</td></tr> <tr><td>2</td><td>140-lb Hammer, 30-inch Drop</td></tr> <tr><td>3</td><td>Pushed</td></tr> <tr><td>4</td><td>Vibrocore (Rotasonic/Geoprobe)</td></tr> <tr><td>5</td><td>Other - See text if applicable</td></tr> </table>	Code	Description	a	3.25-inch O.D., 2.42-inch I.D. Split Spoon	b	2.00-inch O.D., 1.50-inch I.D. Split Spoon	c	Shelby Tube	d	Grab Sample	e	Single-Tube Core Barrel	f	Double-Tube Core Barrel	g	2.50-inch O.D., 2.00-inch I.D. WSDOT	h	3.00-inch O.D., 2.375-inch I.D. Mod. California	i	Other - See text if applicable	1	300-lb Hammer, 30-inch Drop	2	140-lb Hammer, 30-inch Drop	3	Pushed	4	Vibrocore (Rotasonic/Geoprobe)	5	Other - See text if applicable		<table style="width: 100%; border-collapse: collapse;"> <tr> <th style="width: 10%;">Code</th> <th>Description</th> </tr> <tr><td>PP = 1.0</td><td>Pocket Penetrometer, tsf</td></tr> <tr><td>TV = 0.5</td><td>Torvane, tsf</td></tr> <tr><td>PID = 100</td><td>Photoionization Detector VOC screening, ppm</td></tr> <tr><td>W = 10</td><td>Moisture Content, %</td></tr> <tr><td>D = 120</td><td>Dry Density, pcf</td></tr> <tr><td>-200 = 60</td><td>Material smaller than No. 200 sieve, %</td></tr> <tr><td>GS</td><td>Grain Size - See separate figure for data</td></tr> <tr><td>AL</td><td>Atterberg Limits - See separate figure for data</td></tr> <tr><td>GT</td><td>Other Geotechnical Testing</td></tr> <tr><td>CA</td><td>Chemical Analysis</td></tr> </table>	Code	Description	PP = 1.0	Pocket Penetrometer, tsf	TV = 0.5	Torvane, tsf	PID = 100	Photoionization Detector VOC screening, ppm	W = 10	Moisture Content, %	D = 120	Dry Density, pcf	-200 = 60	Material smaller than No. 200 sieve, %	GS	Grain Size - See separate figure for data	AL	Atterberg Limits - See separate figure for data	GT	Other Geotechnical Testing	CA	Chemical Analysis
Code	Description																																																					
a	3.25-inch O.D., 2.42-inch I.D. Split Spoon																																																					
b	2.00-inch O.D., 1.50-inch I.D. Split Spoon																																																					
c	Shelby Tube																																																					
d	Grab Sample																																																					
e	Single-Tube Core Barrel																																																					
f	Double-Tube Core Barrel																																																					
g	2.50-inch O.D., 2.00-inch I.D. WSDOT																																																					
h	3.00-inch O.D., 2.375-inch I.D. Mod. California																																																					
i	Other - See text if applicable																																																					
1	300-lb Hammer, 30-inch Drop																																																					
2	140-lb Hammer, 30-inch Drop																																																					
3	Pushed																																																					
4	Vibrocore (Rotasonic/Geoprobe)																																																					
5	Other - See text if applicable																																																					
Code	Description																																																					
PP = 1.0	Pocket Penetrometer, tsf																																																					
TV = 0.5	Torvane, tsf																																																					
PID = 100	Photoionization Detector VOC screening, ppm																																																					
W = 10	Moisture Content, %																																																					
D = 120	Dry Density, pcf																																																					
-200 = 60	Material smaller than No. 200 sieve, %																																																					
GS	Grain Size - See separate figure for data																																																					
AL	Atterberg Limits - See separate figure for data																																																					
GT	Other Geotechnical Testing																																																					
CA	Chemical Analysis																																																					
<b>Groundwater</b>																																																						
Approximate water level at time of drilling (ATD)																																																						
Approximate water level at time after drilling/excavation/well																																																						

# B-1

LAI Project No: 1490005.010

## SAMPLE DATA

## SOIL PROFILE

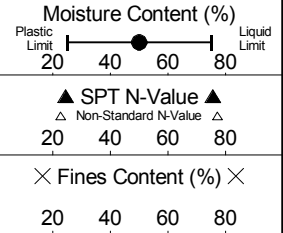

Drilling Method: Hollow-Stem Auger

Ground Elevation (ft): Not Measured

Drilled By: Holocene Drilling Inc.

Logged By: JSN Date: 05/13/20

Groundwater

ATD at 8 ft

Depth (ft)  
 0  
 5  
 10  
 15  
 20  
 25  
 30  
 35

Elevation (ft)	Sample Number & Interval	Sampler Type	Blows/Foot	Test Data	Graphic Symbol	USCS Symbol	Description
0					AC	SP-SM	6 inches of asphalt <b>(ASPHALT)</b>
~4	S-1	b2	26	W = 18 GS			Gray-brown, fine to coarse SAND with silt and gravel (medium dense, moist) <b>(ICE-CONTACT DEPOSITS)</b>
~5	S-2A S-2B	b2	25	W = 21	ML		Brown SILT with sand and gravel (very stiff, moist)
~8	S-3	b2	23		SP-SM		Gray-brown, fine to coarse SAND with silt (medium dense, moist) -Grades to wet and with gravel
~11	S-4	b2	16	W = 22 AL	CL		Gray-brown CLAY (very stiff, moist) -9 inches of heave observed in sampler
~15	S-5	b2	50/ 6"		SM		Gray-brown, silty, fine to coarse SAND with gravel (very dense, moist) -8 inches of heave observed in sampler

Boring Completed 05/13/20  
 Total Depth of Boring = 16.5 ft.

- Notes:
1. Stratigraphic contacts are based on field interpretations and are approximate.
  2. Reference to the text of this report is necessary for a proper understanding of subsurface conditions.
  3. Refer to "Soil Classification System and Key" figure for explanation of graphics and symbols.

1490005.01 7/20/20 C:\USERS\MSK\IN\NERIDESKTOP\1490005.010.GPJ SOIL BORING LOG WITH GRAPH



Bangor-Keyport  
 Force Main Replacement  
 Kitsap County, Washington

Log of Boring B- 1

Figure  
**A-2**

# B-2

LAI Project No: 1490005.010

## SAMPLE DATA

## SOIL PROFILE

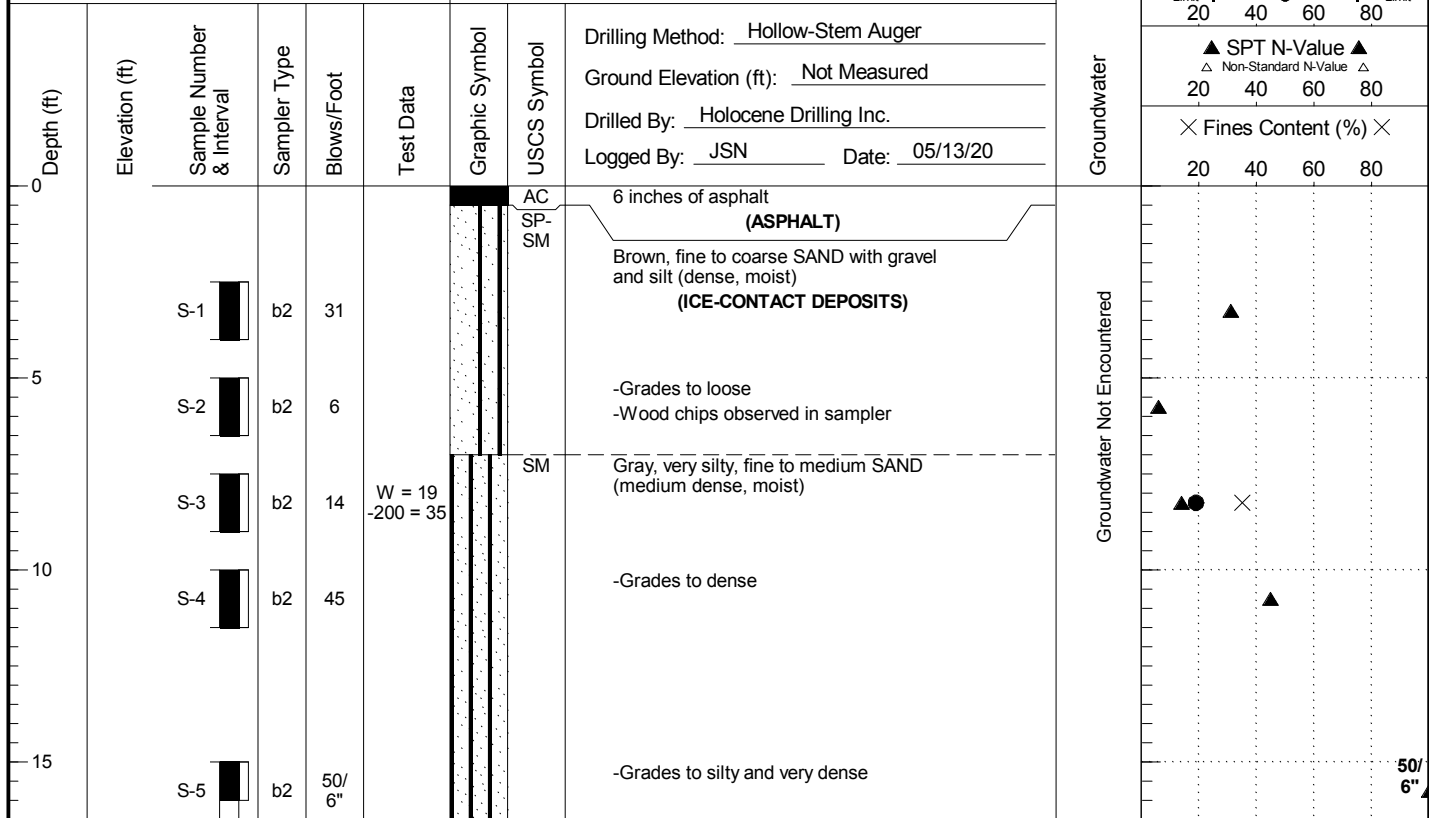

Boring Completed 05/13/20  
 Total Depth of Boring = 16.5 ft.

- Notes:
1. Stratigraphic contacts are based on field interpretations and are approximate.
  2. Reference to the text of this report is necessary for a proper understanding of subsurface conditions.
  3. Refer to "Soil Classification System and Key" figure for explanation of graphics and symbols.

1490005.01 7/20/20 C:\USERS\MSK\IN\NERIDESKTOP\1490005.010.GPJ SOIL BORING LOG WITH GRAPH



Bangor-Keyport  
 Force Main Replacement  
 Kitsap County, Washington

Log of Boring B- 2

Figure  
**A-3**

# B-3

LAI Project No: 1490005.010

## SAMPLE DATA

## SOIL PROFILE

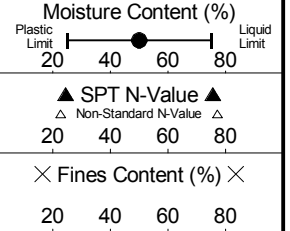

Drilling Method: Hollow-Stem Auger  
 Ground Elevation (ft): Not Measured  
 Drilled By: Holocene Drilling Inc.  
 Logged By: JSN Date: 05/20/20



Elevation (ft)	Sample Number & Interval	Sampler Type	Blows/Foot	Test Data	Graphic Symbol	USCS Symbol	Soil Description
0							
~1.5	S-1	b2	50/5"		○	GP	Brown, very sandy, fine to coarse GRAVEL (very dense, moist) <b>(ICE-CONTACT DEPOSITS)</b>
~4.5	S-2	b2	69		○		
~8.5	S-3	b2	50/1"		○		
~10.5	S-4	b2	50/1.5"		○		

Groundwater

Groundwater Not Encountered

50/5"  
50/1"  
50/1.5"

Boring Completed 05/20/20  
 Total Depth of Boring = 11.5 ft.

- Notes:
1. Stratigraphic contacts are based on field interpretations and are approximate.
  2. Reference to the text of this report is necessary for a proper understanding of subsurface conditions.
  3. Refer to "Soil Classification System and Key" figure for explanation of graphics and symbols.

1490005.01 7/20/20 C:\USERS\MSK\IN\NERIDESKTOP\1490005.010.GPJ SOIL BORING LOG WITH GRAPH



Bangor-Keyport  
 Force Main Replacement  
 Kitsap County, Washington

Log of Boring B- 3

Figure  
**A-4**

# B-4

LAI Project No: 1490005.010

## SAMPLE DATA

## SOIL PROFILE

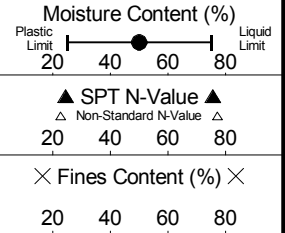

Depth (ft)	Elevation (ft)	Sample Number & Interval	Sampler Type	Blows/Foot	Test Data	Graphic Symbol	USCS Symbol	Groundwater	
								Groundwater	Groundwater Not Encountered
0									
5		S-1	b2	50/6"			GP-GM		
5		S-2	b2	50/5"	W = 5 GS				
10		S-3	b2	50/4"					
10		S-4	b2	50/5"					

Drilling Method: Hollow-Stem Auger  
 Ground Elevation (ft): Not Measured  
 Drilled By: Holocene Drilling Inc.  
 Logged By: JSN Date: 05/20/20

Boring Completed 05/20/20  
 Total Depth of Boring = 11.5 ft.

- Notes:
1. Stratigraphic contacts are based on field interpretations and are approximate.
  2. Reference to the text of this report is necessary for a proper understanding of subsurface conditions.
  3. Refer to "Soil Classification System and Key" figure for explanation of graphics and symbols.

1490005.01 7/20/20 C:\USERS\MSK\IN\NERIDESKTOP\1490005.010.GPJ SOIL BORING LOG WITH GRAPH



Bangor-Keyport  
 Force Main Replacement  
 Kitsap County, Washington

Log of Boring B- 4

Figure  
**A-5**

# B-5

LAI Project No: 1490005.010

## SAMPLE DATA

## SOIL PROFILE

### WELL DETAIL

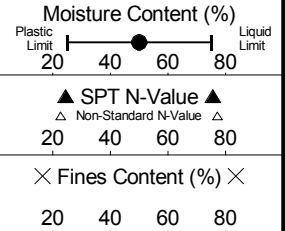

Drilling Method: Rotosonic  
 Ground Elevation (ft): Not Measured  
 Drilled By: Holocene Drilling Inc.  
 Logged By: BP Date: 05/26/20

1490005.01 7/20/20 C:\USERS\MSK\IN\NER\DESKTOP\1490005.010.GPJ SOIL BORING LOG WITH GRAPH

Depth (ft)	Elevation (ft)	Sample Number & Interval	Sampler Type	Blows/Foot	Test Data	Graphic Symbol	USCS Symbol	Soil Profile Description
0								3 inches of sod over dark brown, silty, fine to coarse SAND with trace organics <b>(TOPSOIL)</b>
0 - 5		S-1	d2	12			SM	Brown, silty, fine to coarse SAND with gravel (medium dense, moist) <b>(FILL)</b>
5 - 10		S-2	d2	46	W = 12 GS		SM	-Layer of clean sand, 6 inches Gray, silty, fine to coarse SAND with gravel (dense, moist to wet) <b>(GLACIAL TILL)</b>
10 - 15		S-3	d2	47				-Grades to very silty and gravelly -Fractured rock observed
15 - 20		S-4	d2	50/ 6"	W = 6 GS			-Grades to very dense, moist, and with gravel
20 - 25		S-5	d2	50/ 4"	W = 5 GS			-Grades to silty -Seam of mottled sand -Fractured rock observed
25 - 30		S-6	d2	50/ 4"				-Seam of mottling
30 - 35		S-7A S-7B	d2	50/ 4"	W = 6 GS		SP	-Grades to gravelly Gray, fine to coarse SAND (very dense, moist)

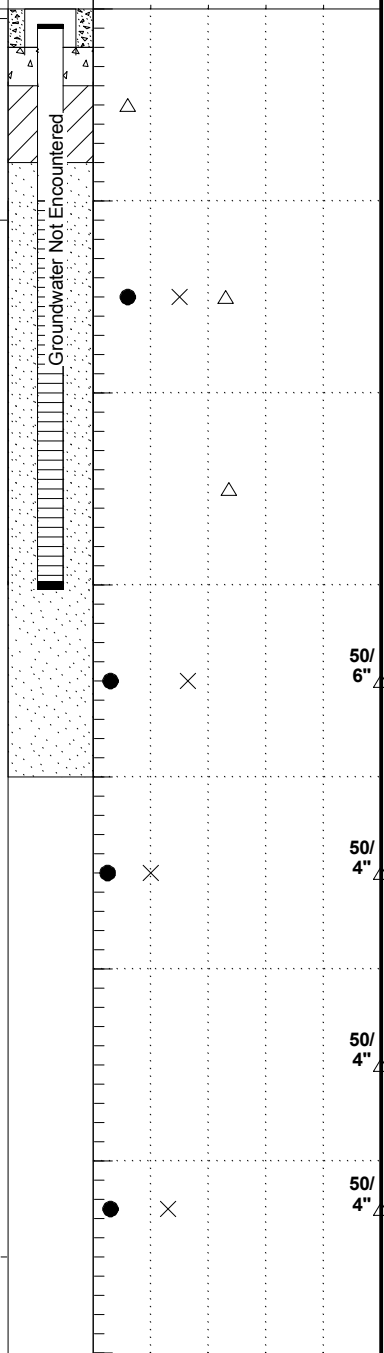

- Notes:
1. Stratigraphic contacts are based on field interpretations and are approximate.
  2. Reference to the text of this report is necessary for a proper understanding of subsurface conditions.
  3. Refer to "Soil Classification System and Key" figure for explanation of graphics and symbols.



Bangor-Keyport  
Force Main Replacement  
Kitsap County, Washington

Log of Boring B- 5

Figure  
A-6  
(1 of 2)

# B-5

LAI Project No: 1490005.010

## SAMPLE DATA

## SOIL PROFILE

## WELL DETAIL

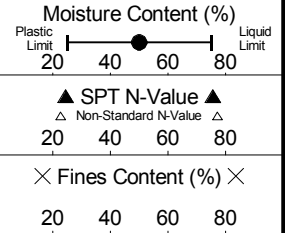

Drilling Method: Rotosonic  
 Ground Elevation (ft): Not Measured  
 Drilled By: Holocene Drilling Inc.  
 Logged By: BP Date: 05/26/20

Depth (ft)

Elevation (ft)

Sample Number & Interval

Sampler Type

Blows/Foot

Test Data

Graphic Symbol

USCS Symbol

35	S-8	d2	50/ 5"		SP	Gray, fine to coarse SAND (very dense, moist)  -Grades to gravelly -Fractured rock observed	Groundwater Not Encountered	50/ 5" ▲
40	S-9	d2	50/ 5"		SM	Gray, silty, fine to coarse SAND with gravel (very dense, moist)		50/ 5" ▲
45	S-10	d2	50/ 6"		SP-SM	Gray, fine to coarse SAND with silt and gravel (very dense, moist)		50/ 6" ▲
50	S-11	d2	50/ 6"		SP	Gray, fine to coarse SAND with gravel (very dense, moist)  -Fractured rock observed		50/ 6" ▲
55	S-12	d2	57					50/ 4" ▲
60		b2	50/ 4"					50/ 4" ▲

Boring Completed 05/26/20  
 Total Depth of Boring = 61.5 ft.

- Notes:
1. Stratigraphic contacts are based on field interpretations and are approximate.
  2. Reference to the text of this report is necessary for a proper understanding of subsurface conditions.
  3. Refer to "Soil Classification System and Key" figure for explanation of graphics and symbols.

1490005.01 7/20/20 C:\USERS\MSK\IN\NERIDESKTOP\1490005.010.GPJ SOIL BORING LOG WITH GRAPH



Bangor-Keyport  
 Force Main Replacement  
 Kitsap County, Washington

Log of Boring B- 5

Figure  
 A-6  
 (2 of 2)



# B-6

LAI Project No: 1490005.010

## SAMPLE DATA

## SOIL PROFILE

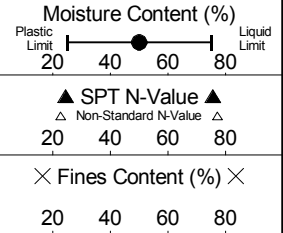

Drilling Method: Rotosonic  
 Ground Elevation (ft): Not Measured  
 Drilled By: Holocene Drilling Inc.  
 Logged By: BP Date: 05/27/20

Groundwater

Depth (ft)

Elevation (ft)	Sample Number & Interval	Sampler Type	Blows/Foot	Test Data	Graphic Symbol	USCS Symbol	Description
0	S-1A	d2				AC	4 inches of asphalt over 4 inches of crushed rock base course <b>(ASPHALT)</b>
0-5	S-1B					GM	Gray, silty, very sandy, fine to coarse GRAVEL (very dense, damp to moist) <b>(FILL)</b>
5-10	S-2	d2	50/1"			GP-GM	Gray, very sandy, fine to coarse GRAVEL with silt (very dense, moist) <b>(GLACIAL TILL)</b> -Drilling action/chatter suggests presence of large cobbles or boulder -Fractured rock observed
10-15	S-3	d2	50/1"	W = 2 GS			-Fractured rock observed
15-20	S-4	d2	50/6"	W = 4 GS		SM	Gray, silty, gravelly, fine to coarse SAND (very dense, moist)
20-25	S-5	d2	50/6"				-Seam of mottling -Grades to without gravel
25-30	S-6A	d2	50/6"	W = 8 GS			
30-35	S-6B					SP-SM	Gray, fine to coarse SAND with silt (very dense, moist)
35-40	S-7	d2	50/6"	W = 8 GS			-Grades to gravelly -Driller added water to lubricate/cool tooling -Silt layer observed

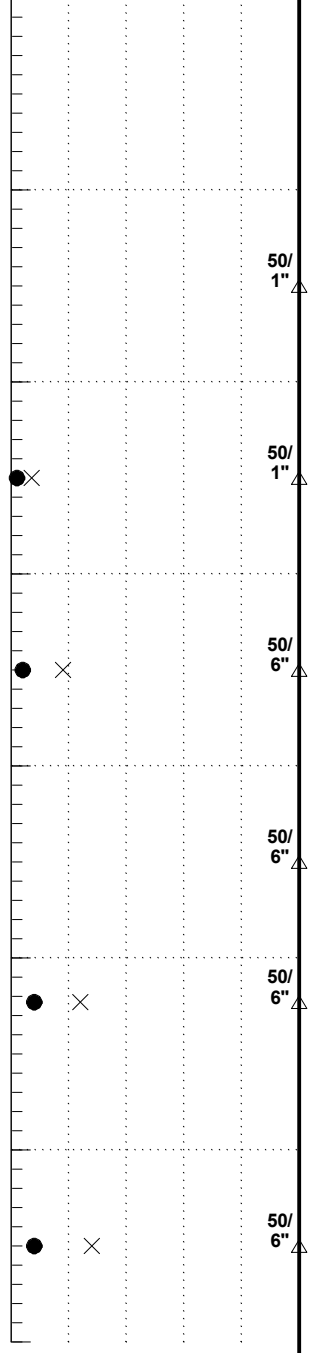

- Notes:
1. Stratigraphic contacts are based on field interpretations and are approximate.
  2. Reference to the text of this report is necessary for a proper understanding of subsurface conditions.
  3. Refer to "Soil Classification System and Key" figure for explanation of graphics and symbols.

1490005.01 7/20/20 C:\USERS\MSK\IN\NERIDESKTOP\1490005.010.GPJ SOIL BORING LOG WITH GRAPH



Bangor-Keyport  
Force Main Replacement  
Kitsap County, Washington

Log of Boring B- 6

Figure  
A-7  
(1 of 2)

# B-6

LAI Project No: 1490005.010

## SAMPLE DATA

## SOIL PROFILE

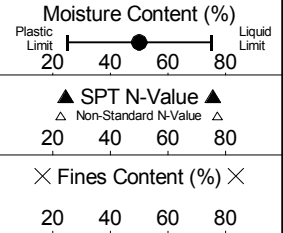

Drilling Method: Rotosonic  
 Ground Elevation (ft): Not Measured  
 Drilled By: Holocene Drilling Inc.  
 Logged By: BP Date: 05/27/20

Groundwater

40.0 ft ATD

Depth (ft)

Elevation (ft)

Sample Number & Interval

Sampler Type

Blows/Foot

Test Data

Graphic Symbol

USCS Symbol

SM  
 Gray, silty, fine to coarse SAND with gravel (very dense, moist)

S-8A

d2

50/5"

W = 7  
GS

SM

S-8B

d2

50/5"

W = 11  
GS

ML

Gray SILT with gravel and sand (hard, moist)

S-9

d2

50/5"

W = 11  
GS

SP-SM

Gray, fine to coarse SAND with silt and gravel (very dense, wet)

-Fractured rock observed

S-10

d2

31

SP

-Silt layer, 2 inches thick; grades to gravelly  
 Gray, fine to coarse SAND with gravel (dense, wet)

S-11

d2

50/6"

SP

-Grades to very dense

S-12

d2

45

b2

-Grades to dense

b2

b2

32

-Silt layer, 3 inches thick

Boring Completed 05/27/20  
 Total Depth of Boring = 61.5 ft.

- Notes:
1. Stratigraphic contacts are based on field interpretations and are approximate.
  2. Reference to the text of this report is necessary for a proper understanding of subsurface conditions.
  3. Refer to "Soil Classification System and Key" figure for explanation of graphics and symbols.

1490005.01 7/20/20 C:\USERS\MSK\IN\NERIDESKTOP\1490005.010.GPJ SOIL BORING LOG WITH GRAPH



Bangor-Keyport  
 Force Main Replacement  
 Kitsap County, Washington

Log of Boring B- 6

Figure  
 A-7  
 (2 of 2)

# B-7

LAI Project No: 1490005.010

## SAMPLE DATA

## SOIL PROFILE

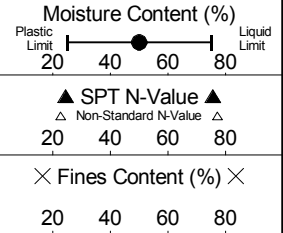

Drilling Method: Rotosonic  
 Ground Elevation (ft): Not Measured  
 Drilled By: Holocene Drilling Inc.  
 Logged By: BP Date: 05/28/20

Groundwater

Depth (ft)  
 0  
 5  
 10  
 15  
 20  
 25  
 30  
 35

Elevation (ft)	Sample Number & Interval	Sampler Type	Blows/Foot	Test Data	Graphic Symbol	USCS Symbol	Soil Description
0						SM	Sod over dark brown, silty, fine to coarse SAND with trace organics <b>(TOPSOIL)</b>
0-1	S-1	d2				SM	Gray, silty, fine to coarse SAND with gravel (dense, moist) <b>(FILL)</b> -Seam of mottling -Stratified layers of brown and gray sand
1-2	S-2A	d2	49	W = 5 GS			-Grades to gravelly
2-3	S-2B						
3-4	S-3	d2	25	W = 9 GS		SP-SM	Gray, fine to coarse SAND with silt and gravel (medium dense, moist) -Grades to brown -Grades to gray
4-5	S-4A	d2	30	W = 9 GS		SM	Brown, silty, gravelly, fine to coarse SAND with trace organics (medium dense, moist) -Layer of clean sand, 5 inches thick
5-6	S-4B					SP-SM	-Grades to dark brown, dense, and very silty Red-brown, gravelly, fine to coarse SAND with silt (medium dense, moist) -Grades to gray -Grades to moist to wet
6-7	S-5	d2	16	W = 20 GS		ML	Mottled, red-brown, sandy SILT with gravel (hard, moist)
7-8	S-6	d2	42	W = 18 GS		SP-SM	Gray, fine to coarse SAND with silt and gravel (medium dense, moist) -Layer of silt observed
8-9	S-7A	d2	25	W = 23		ML	-Fractured rock observed Gray, very sandy SILT (hard, moist) <b>(GLACIAL TILL)</b>
9-10	S-7B					SP-SM	-Grades to with sand and very stiff -Fractured cobble, 3 inches in diameter Gray, fine to coarse SAND with silt and gravel (medium dense, moist)

35.0 ft ATD

- Notes:
1. Stratigraphic contacts are based on field interpretations and are approximate.
  2. Reference to the text of this report is necessary for a proper understanding of subsurface conditions.
  3. Refer to "Soil Classification System and Key" figure for explanation of graphics and symbols.

1490005.01 7/20/20 C:\USERS\MSK\IN\NERIDESKTOP\1490005.010.GPJ SOIL BORING LOG WITH GRAPH



Bangor-Keyport  
 Force Main Replacement  
 Kitsap County, Washington

Log of Boring B- 7

Figure  
 A-8  
 (1 of 2)

# B-7

LAI Project No: 1490005.010

## SAMPLE DATA

## SOIL PROFILE

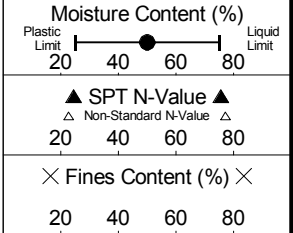

Drilling Method: Rotosonic  
 Ground Elevation (ft): Not Measured  
 Drilled By: Holocene Drilling Inc.  
 Logged By: BP Date: 05/28/20

Groundwater

Depth (ft)

Elevation (ft)	Sample Number & Interval	Sampler Type	Blows/Foot	Test Data	Graphic Symbol	USCS Symbol	Description
35	S-8	d2	50/6"	W = 10 GS	[Symbol]	SP-SM	Gray, fine to coarse SAND with silt and gravel (very dense, wet) <b>(GLACIAL TILL)</b> -Layer of very silty sand, 6 inches thick -Grades to moist to wet
40	S-9	d2	69	W = 10 GS	[Symbol]	SM	Gray, silty, fine to coarse SAND with gravel (very dense, moist)  -Grades to gravelly
45	S-10	d2	50/5"	W = 6 GS	[Symbol]	SM	
50	S-11	d2	50/6"		[Symbol]	GM	Gray, silty, sandy, fine to coarse GRAVEL (very dense, moist)
55	S-12	d2	50/5"		[Symbol]	SM	Gray, silty, gravelly, fine to coarse SAND (very dense, moist) -Fractured cobble, 3 inches in diameter
60							

Boring Completed 05/28/20  
 Total Depth of Boring = 60.0 ft.

- Notes:
1. Stratigraphic contacts are based on field interpretations and are approximate.
  2. Reference to the text of this report is necessary for a proper understanding of subsurface conditions.
  3. Refer to "Soil Classification System and Key" figure for explanation of graphics and symbols.

1490005.01 7/20/20 C:\USERS\MSK\IN\NERIDESKTOP\1490005.010.GPJ SOIL BORING LOG WITH GRAPH



Bangor-Keyport  
 Force Main Replacement  
 Kitsap County, Washington

Log of Boring B- 7

Figure  
 A-8  
 (2 of 2)

# B-8

LAI Project No: 1490005.010

## SAMPLE DATA

## SOIL PROFILE

### WELL DETAIL

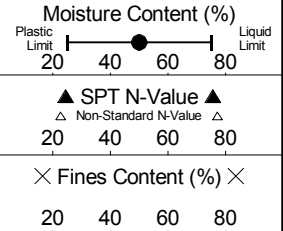

Drilling Method: Rotosonic  
 Ground Elevation (ft): Not Measured  
 Drilled By: Holocene Drilling Inc.  
 Logged By: BP Date: 05/29/20

1490005.01 7/20/20 C:\USERS\MSK\IN\NERIDESKTOP\1490005.010.GPJ SOIL BORING LOG WITH GRAPH

Depth (ft)	Elevation (ft)	Sample Number & Interval	Sampler Type	Blows/Foot	Test Data	Graphic Symbol	USCS Symbol	Soil Profile Description
0							AC	4 inches of asphalt over 4 inches of crushed rock base course <b>(ASPHALT)</b>
0 - 2		S-1	d2				SM	Gray, silty, gravelly, fine to coarse SAND (dense, moist) <b>(FILL)</b>
2 - 5								-Grades to gray-brown -Stratified, gray sand layers observed from 5 to 15 feet
5 - 8		S-2	d2	48	W = 6 GS			-Seam of mottling -Fractured rock observed
8 - 10								-Grades to brown -Grades to gray-brown
10 - 12		S-3A	d2	48	W = 6 -200 = 22			
12 - 14		S-3B						-Dark brown silt layer, 5 inches thick; grades to with gravel
14 - 17		S-4	d2	39	W = 5 GS			-Silt layer, 3 inches thick; grades to very gravelly
17 - 20								-Grades to without gravel -Layer of silt with trace organics
20 - 22		S-5A	d2	44	W = 10			-Clean sand layer, 3 inches thick -Grades to gray
22 - 25		S-5B			W = 19 -200 = 16			-Grades to dark brown, silty, and with gravel and trace organics -Grades to medium dense, gray, and gravelly
25 - 28		S-6	d2	21	W = 6 GS			
28 - 30								
30 - 32		S-7A	d2	17	W = 19		ML	Red-brown SILT with sand and trace organics (very stiff, moist) <b>(GLACIAL TILL)</b>
32 - 35		S-7B					SP-SM	Gray, fine to coarse SAND with silt (medium dense, moist to wet)

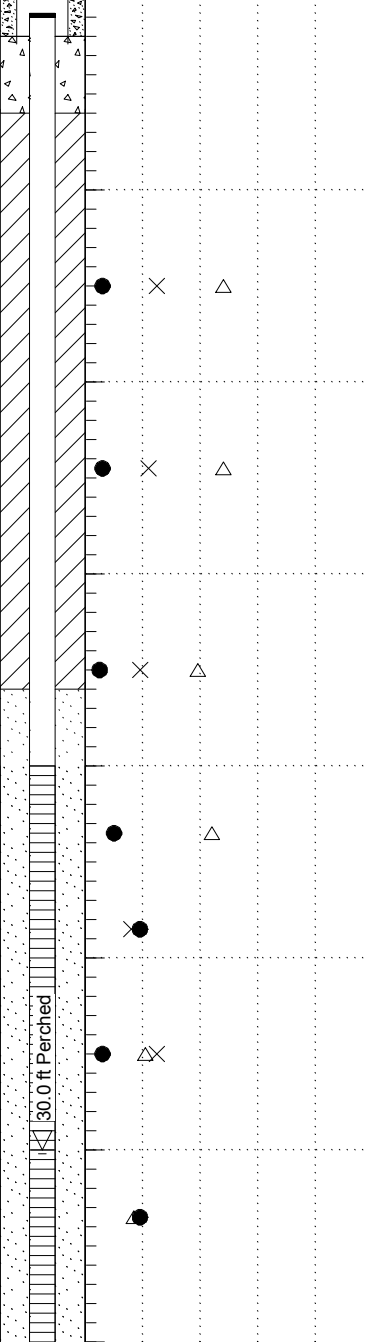

- Notes:
- Stratigraphic contacts are based on field interpretations and are approximate.
  - Reference to the text of this report is necessary for a proper understanding of subsurface conditions.
  - Refer to "Soil Classification System and Key" figure for explanation of graphics and symbols.



Bangor-Keyport  
Force Main Replacement  
Kitsap County, Washington

Log of Boring B- 8

Figure  
A-9  
(1 of 2)

# B-8

LAI Project No: 1490005.010

## SAMPLE DATA

## SOIL PROFILE

### WELL DETAIL

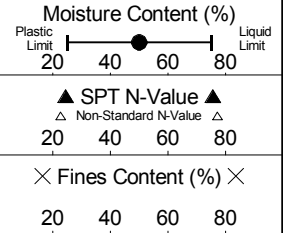

Drilling Method: Rotosonic  
 Ground Elevation (ft): Not Measured  
 Drilled By: Holocene Drilling Inc.  
 Logged By: BP Date: 05/29/20

1490005.01 7/20/20 C:\USERS\MSK\IN\NERIDESKTOP\1490005.010.GPJ SOIL BORING LOG WITH GRAPH

Depth (ft)	Elevation (ft)	Sample Number & Interval	Sampler Type	Blows/Foot	Test Data	Graphic Symbol	USCS Symbol	Soil Description
35		S-8	d2	35	W = 20 GS	[Symbol]	SP-SM	Gray, fine to coarse SAND with silt (dense, moist to wet) <b>(GLACIAL TILL)</b>
40		S-9	d2	50/6"		[Symbol]	SM	Gray, silty, fine to coarse SAND with gravel (very dense, moist)  -Drillers added water to mitigate heave
45		S-10	d2	50/6"	W = 5 GS	[Symbol]	SP-SM	Gray, fine to coarse SAND with silt and gravel (very dense, moist)
50		S-11A	d2	50/6"		[Symbol]	SM	Gray, gravelly, silty, fine to coarse SAND (very dense, moist)
55		S-11B	d2			[Symbol]	SP	Gray, fine to coarse SAND (very dense, wet)
		S-12	d2	50/6"		[Symbol]	ML	Gray SILT with sand and gravel (hard, wet)
60				50/5"		[Symbol]	SP	Gray, fine to coarse SAND with gravel (very dense, wet)
						[Symbol]	ML	Gray SILT with sand (hard, moist)  -Fractured cobble, 3 inches in diameter

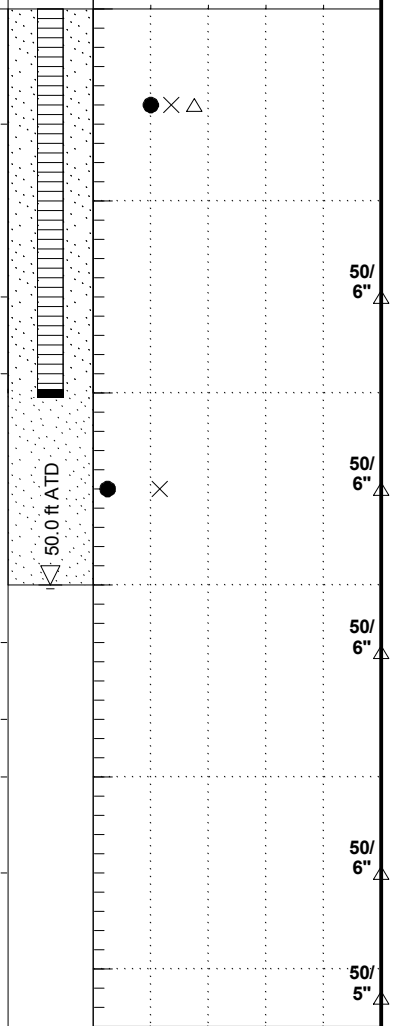

Boring Completed 05/29/20  
 Total Depth of Boring = 61.5 ft.

- Notes:
1. Stratigraphic contacts are based on field interpretations and are approximate.
  2. Reference to the text of this report is necessary for a proper understanding of subsurface conditions.
  3. Refer to "Soil Classification System and Key" figure for explanation of graphics and symbols.



# B-9

LAI Project No: 1490005.010

## SAMPLE DATA

## SOIL PROFILE

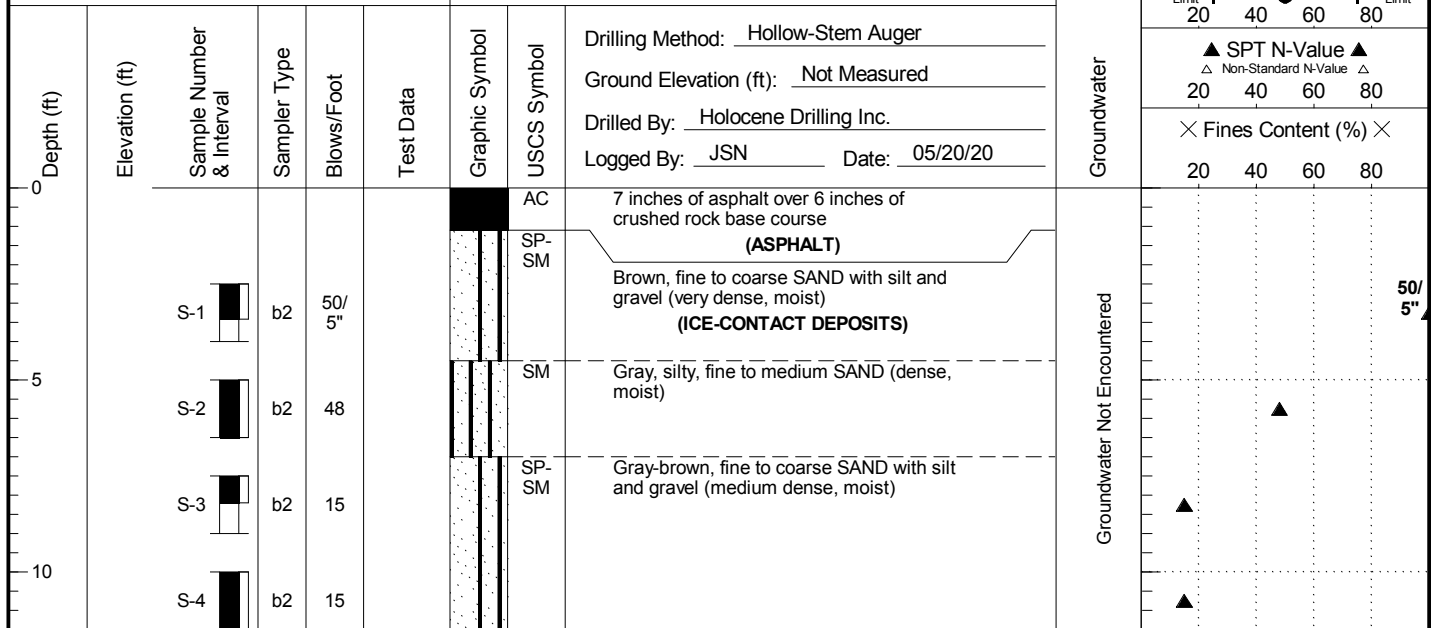

Boring Completed 05/20/20  
Total Depth of Boring = 11.5 ft.

- Notes:
1. Stratigraphic contacts are based on field interpretations and are approximate.
  2. Reference to the text of this report is necessary for a proper understanding of subsurface conditions.
  3. Refer to "Soil Classification System and Key" figure for explanation of graphics and symbols.

1490005.01 7/20/20 C:\USERS\MSK\IN\NER\DESK\TOP\1490005.010.GPJ SOIL BORING LOG WITH GRAPH



Bangor-Keyport  
Force Main Replacement  
Kitsap County, Washington

Log of Boring B- 9

Figure  
**A-10**

# B-10

LAI Project No: 1490005.010

## SAMPLE DATA

## SOIL PROFILE

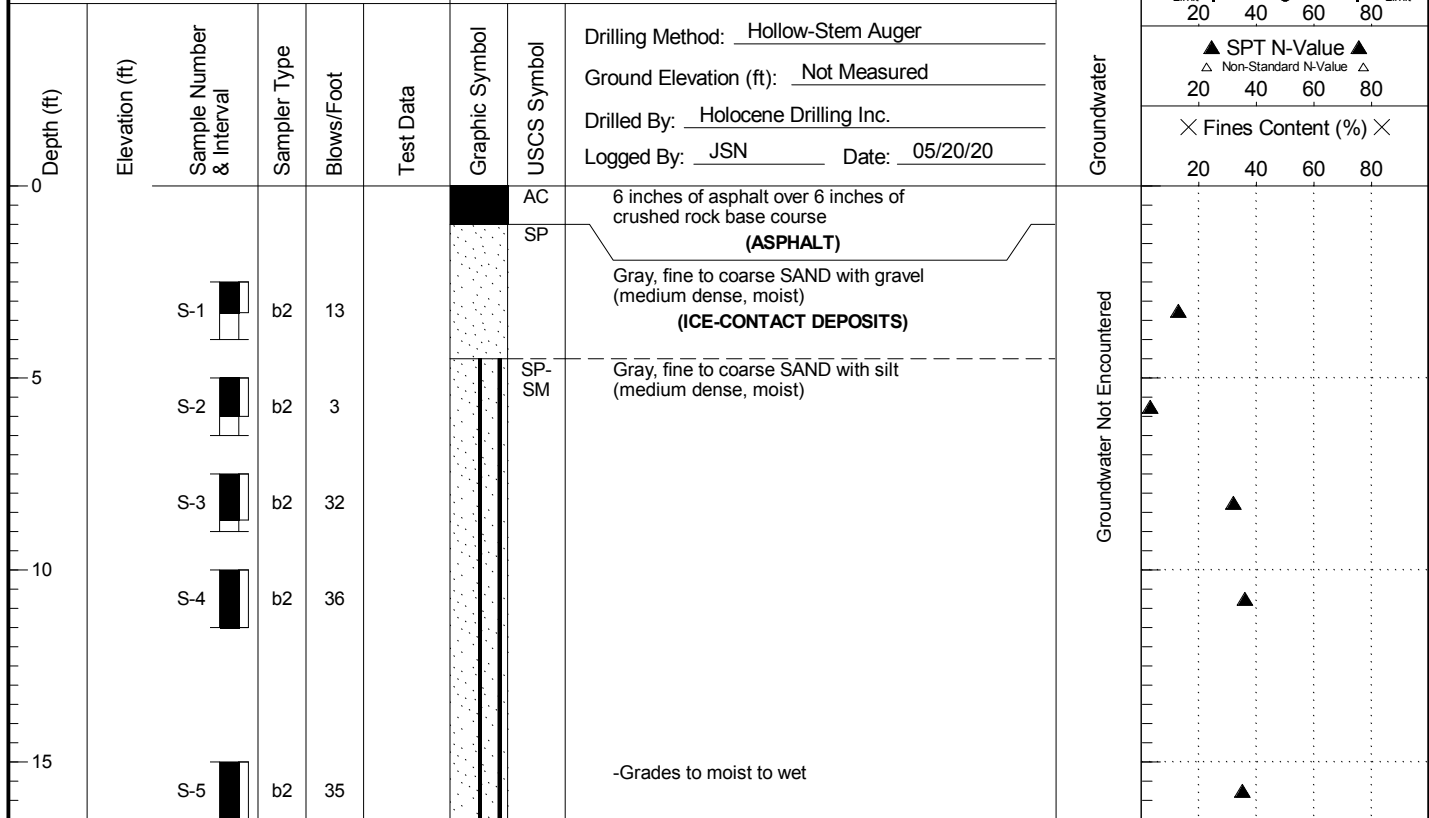

Boring Completed 05/20/20  
Total Depth of Boring = 16.5 ft.

- Notes:
1. Stratigraphic contacts are based on field interpretations and are approximate.
  2. Reference to the text of this report is necessary for a proper understanding of subsurface conditions.
  3. Refer to "Soil Classification System and Key" figure for explanation of graphics and symbols.

1490005.01 7/20/20 C:\USERS\MSK\IN\NER\DESK\TOP\1490005.010.GPJ SOIL BORING LOG WITH GRAPH



Bangor-Keyport  
Force Main Replacement  
Kitsap County, Washington

Log of Boring B-10

Figure  
**A-11**



# HA-11

LAI Project No: 1490005.010

## SAMPLE DATA

## SOIL PROFILE

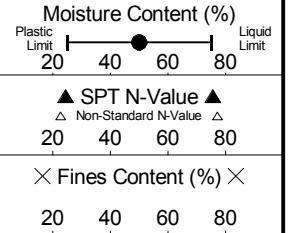

Depth (ft)	Elevation (ft)	Sample Number & Interval	Sampler Type	Blows/Foot	Test Data	Graphic Symbol	USCS Symbol	Soil Profile Description	
								Drilling Method	Ground Elevation (ft)
								Drilling Method: Hand Auger	
								Ground Elevation (ft): Not Measured	
								Drilled By: Landau Associates, Inc.	
								Logged By: AMW Date: 05/26/20	
0							SM	Grass over brown, silty, gravelly, fine to coarse SAND with trace organics (loose, moist)	
		S-1	d				SP-SM	(TOPSOIL)	
								Gray, fine to coarse SAND with silt and gravel (medium dense, moist to wet)	
								(FILL)	
2		S-2	d				SM	-Grades to wet and gravelly	
								Gray, silty, gravelly, fine to coarse SAND (very dense, moist)	
								(ICE-CONTACT DEPOSITS)	

Slow Seepage at 1 ft Groundwater

Boring Completed 05/26/20  
 Total Depth of Boring = 2.0 ft.

1490005.01 7/20/20 C:\USERS\MSK\IN\NERIDESKTOP\1490005.010.GPJ SOIL BORING LOG WITH GRAPH

- Notes:
1. Stratigraphic contacts are based on field interpretations and are approximate.
  2. Reference to the text of this report is necessary for a proper understanding of subsurface conditions.
  3. Refer to "Soil Classification System and Key" figure for explanation of graphics and symbols.



Bangor-Keyport  
 Force Main Replacement  
 Kitsap County, Washington

Log of Boring HA-11

Figure  
**A-12**

# B-12

LAI Project No: 1490005.010

## SAMPLE DATA

## SOIL PROFILE

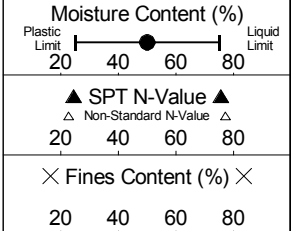

Drilling Method: Hollow-Stem Auger  
 Ground Elevation (ft): Not Measured  
 Drilled By: Holocene Drilling Inc.  
 Logged By: JSN Date: 05/12/20

Groundwater

1490005.01 7/20/20 C:\USERS\MSK\IN\NERIDESKTOP\1490005.010.GPJ SOIL BORING LOG WITH GRAPH

Depth (ft)	Elevation (ft)	Sample Number & Interval	Sampler Type	Blows/Foot	Test Data	Graphic Symbol	USCS Symbol	Soil Description
0						AC	SP-SM	6 inches of asphalt <b>(ASPHALT)</b>
0-5		S-1	b2	50/6"	W = 3	[Symbol]	SP-SM	Brown, gravelly, fine to coarse SAND with silt (very dense, damp to moist) <b>(ICE-CONTACT DEPOSITS)</b>
5-10		S-2	b2	50/5"		[Symbol]	SP-SM	-Grades to gray-brown, without gravel, and dense
10-15		S-3	b2	31		[Symbol]	SP-SM	-Grades to very dense
15-20		S-4	b2	50		[Symbol]	SP-SM	-Grades to moist
20-25		S-5	b2	50/4"		[Symbol]	SM	Brown-black, silty, fine to coarse SAND with gravel and trace organics (loose, moist)
25-30		S-6	b2	6	W = 33 GS	[Symbol]	SP-SM	Gray, fine to coarse SAND with silt (very dense, moist)
30-35		S-7	b2	64		[Symbol]	SP-SM	-Grades to wet

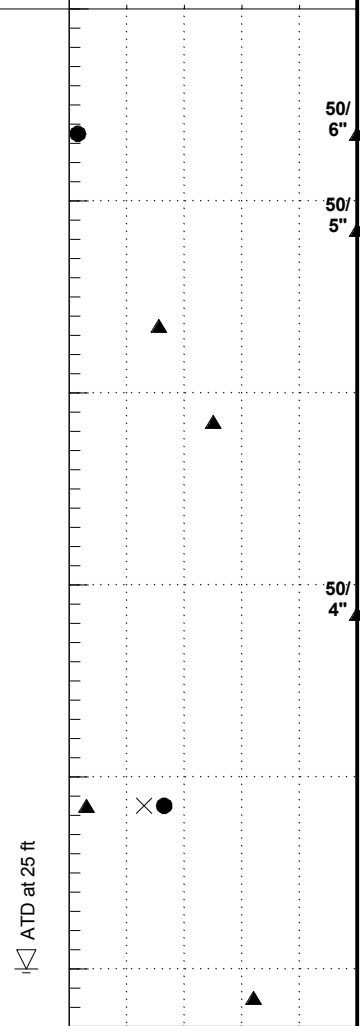

Boring Completed 05/12/20  
 Total Depth of Boring = 26.5 ft.

- Notes:
1. Stratigraphic contacts are based on field interpretations and are approximate.
  2. Reference to the text of this report is necessary for a proper understanding of subsurface conditions.
  3. Refer to "Soil Classification System and Key" figure for explanation of graphics and symbols.

ATD at 25 ft



Bangor-Keyport  
 Force Main Replacement  
 Kitsap County, Washington

Log of Boring B-12

Figure  
**A-13**

# B-13

LAI Project No: 1490005.010

## SAMPLE DATA

## SOIL PROFILE

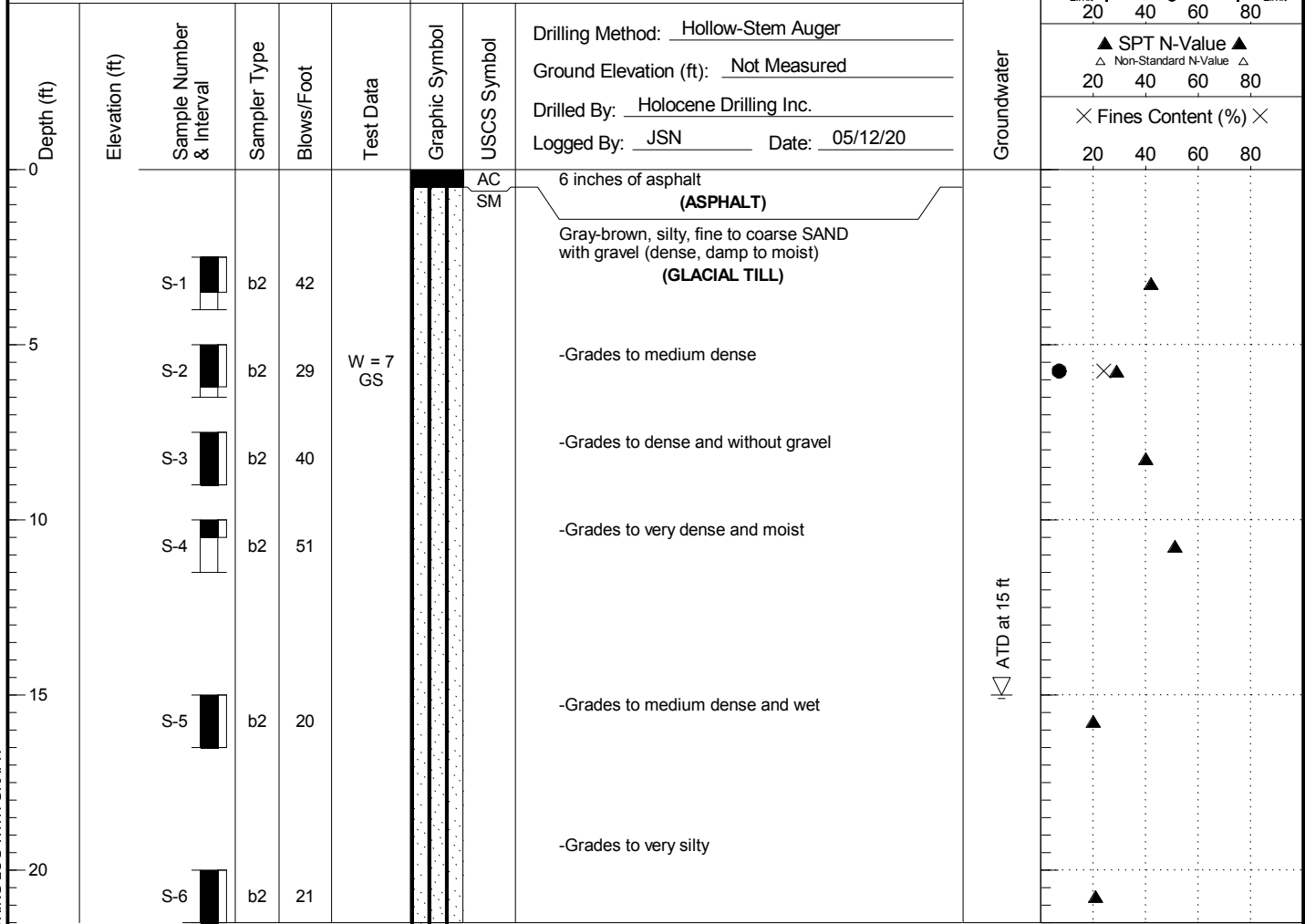

Boring Completed 05/12/20  
Total Depth of Boring = 21.5 ft.

- Notes:
1. Stratigraphic contacts are based on field interpretations and are approximate.
  2. Reference to the text of this report is necessary for a proper understanding of subsurface conditions.
  3. Refer to "Soil Classification System and Key" figure for explanation of graphics and symbols.

1490005.01 7/20/20 C:\USERS\MSK\IN\NERIDESKTOP\1490005.010.GPJ SOIL BORING LOG WITH GRAPH



Bangor-Keyport  
Force Main Replacement  
Kitsap County, Washington

Log of Boring B-13

Figure  
**A-14**

# B-14

LAI Project No: 1490005.010

## SAMPLE DATA

## SOIL PROFILE

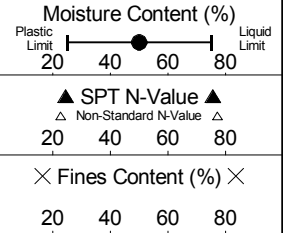

Drilling Method: Hollow-Stem Auger  
 Ground Elevation (ft): Not Measured  
 Drilled By: Holocene Drilling Inc.  
 Logged By: JSN Date: 05/20/20

1490005.01 7/20/20 C:\USERS\MSK\IN\NERIDESKTOP\1490005.010.GPJ SOIL BORING LOG WITH GRAPH

Depth (ft)	Elevation (ft)	Sample Number & Interval	Sampler Type	Blows/Foot	Test Data	Graphic Symbol	USCS Symbol	Soil Description
0							GP SM	6 inches of gravel surfacing (FILL) Brown, silty, gravelly, fine to coarse SAND (very dense, moist) <b>(GLACIAL TILL)</b> -Grades to gray, very silty, and damp to moist
1-2		S-1	b2	50/3"	W = 6 GS			
2-3		S-2	b2	50/6"	W = 8 -200 = 34			
3-4		S-3	b2	88				
4-5		S-4	b2	50/6"	W = 8			
5-6		S-5	b2	50/4"				
6-7		S-6	b2	50/6"				-Grades to moist

Groundwater

Groundwater Not Encountered

Boring Completed 05/20/20  
 Total Depth of Boring = 21.5 ft.

- Notes:
1. Stratigraphic contacts are based on field interpretations and are approximate.
  2. Reference to the text of this report is necessary for a proper understanding of subsurface conditions.
  3. Refer to "Soil Classification System and Key" figure for explanation of graphics and symbols.



Bangor-Keyport  
 Force Main Replacement  
 Kitsap County, Washington

Log of Boring B-14

Figure  
**A-15**

# B-15

LAI Project No: 1490005.010

## SAMPLE DATA

## SOIL PROFILE

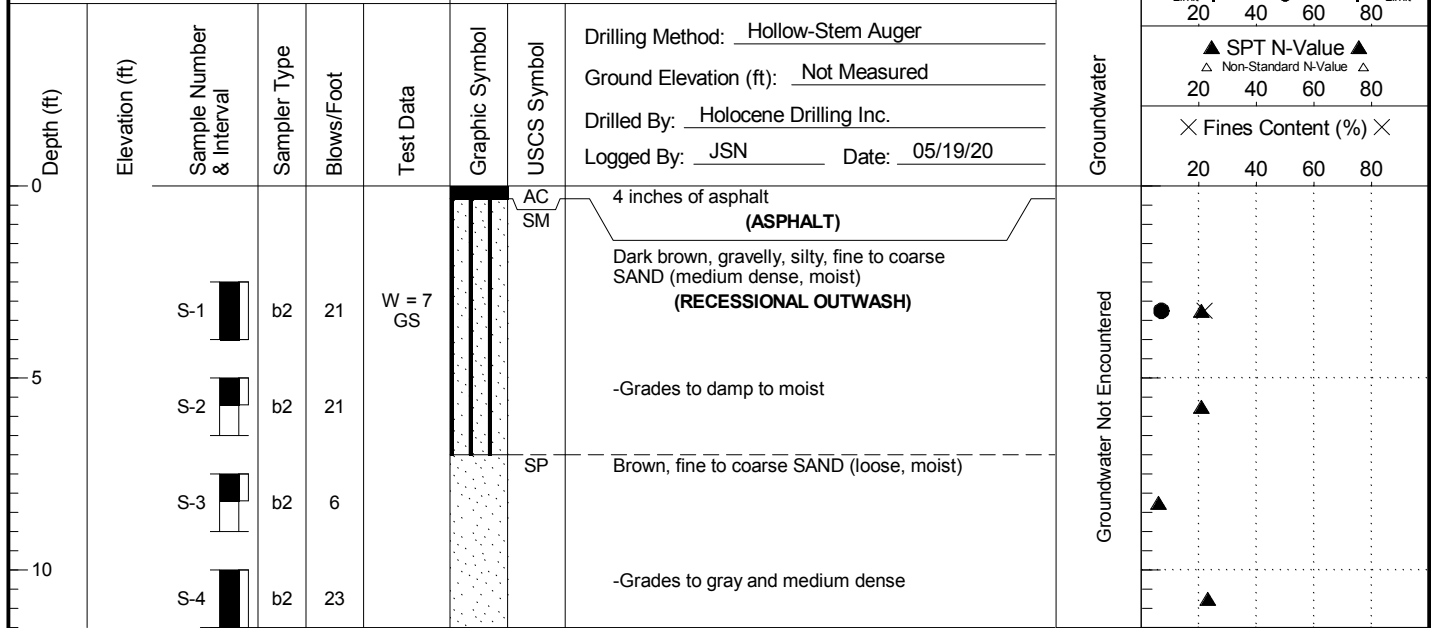

Boring Completed 05/19/20  
Total Depth of Boring = 11.5 ft.

- Notes:
1. Stratigraphic contacts are based on field interpretations and are approximate.
  2. Reference to the text of this report is necessary for a proper understanding of subsurface conditions.
  3. Refer to "Soil Classification System and Key" figure for explanation of graphics and symbols.

1490005.01 7/20/20 C:\USERS\MSK\IN\NERIDESKTOP\1490005.010.GPJ SOIL BORING LOG WITH GRAPH



Bangor-Keyport  
Force Main Replacement  
Kitsap County, Washington

Log of Boring B-15

Figure  
**A-16**

# B-16

LAI Project No: 1490005.010

## SAMPLE DATA

## SOIL PROFILE

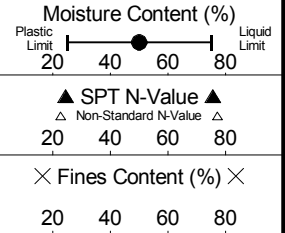

Drilling Method: Hollow-Stem Auger  
 Ground Elevation (ft): Not Measured  
 Drilled By: Holocene Drilling Inc.  
 Logged By: JSN Date: 05/19/20

Groundwater

1490005.01 7/20/20 C:\USERS\MSK\IN\NERIDESKTOP\1490005.010.GPJ SOIL BORING LOG WITH GRAPH

Depth (ft)	Elevation (ft)	Sample Number & Interval	Sampler Type	Blows/Foot	Test Data	Graphic Symbol	USCS Symbol	Description
0						AC SP		5 inches of asphalt over 1.5 inches of crushed rock base course <b>(ASPHALT)</b>
1-4		S-1	b2	14				Gray, fine to coarse SAND (medium dense, moist) <b>(RECESSIONAL OUTWASH)</b>
4-5		S-2	b2	6		SP-SM		Gray, fine to coarse SAND with silt and gravel (loose, moist)
5-7		S-3	b2	8				-Grades to without gravel
7-10		S-4	b2	7		SM		Gray, silty, fine to medium SAND (loose, moist)
10-15		S-5A S-5B	b2 b2	21				-Grades to medium dense -Silt layer, 6 inches thick
15-16.5								-Grades to wet

ATD at 16 ft

Boring Completed 05/19/20  
 Total Depth of Boring = 16.5 ft.

- Notes:
1. Stratigraphic contacts are based on field interpretations and are approximate.
  2. Reference to the text of this report is necessary for a proper understanding of subsurface conditions.
  3. Refer to "Soil Classification System and Key" figure for explanation of graphics and symbols.



Bangor-Keyport  
 Force Main Replacement  
 Kitsap County, Washington

Log of Boring B-16

Figure  
**A-17**

# B-17

LAI Project No: 1490005.010

## SAMPLE DATA

## SOIL PROFILE

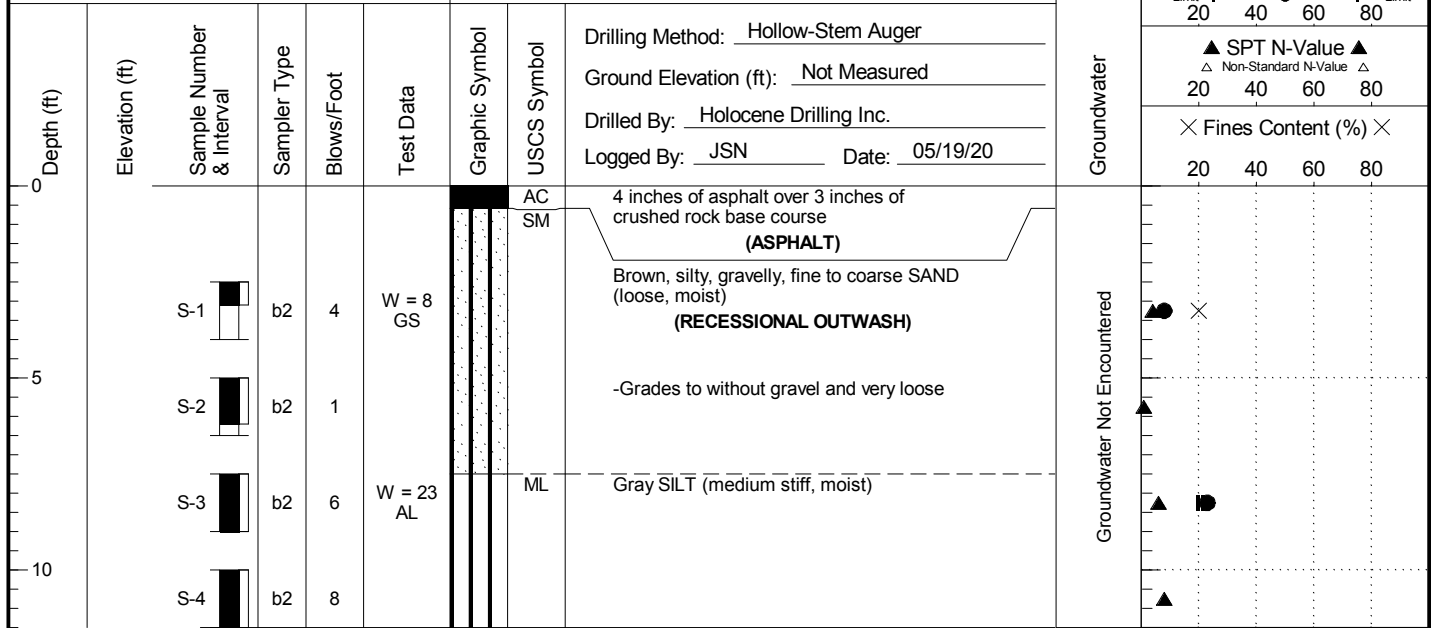

Boring Completed 05/19/20  
Total Depth of Boring = 11.5 ft.

- Notes:
1. Stratigraphic contacts are based on field interpretations and are approximate.
  2. Reference to the text of this report is necessary for a proper understanding of subsurface conditions.
  3. Refer to "Soil Classification System and Key" figure for explanation of graphics and symbols.

1490005.01 7/20/20 C:\USERS\MSK\IN\NERIDESKTOP\1490005.010.GPJ SOIL BORING LOG WITH GRAPH



Bangor-Keyport  
Force Main Replacement  
Kitsap County, Washington

Log of Boring B-17

Figure  
**A-18**

# B-18

LAI Project No: 1490005.010

## SAMPLE DATA

## SOIL PROFILE

Groundwater

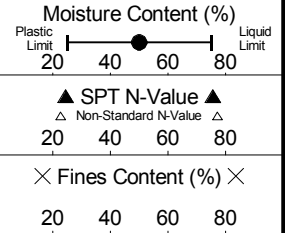

Drilling Method: Hollow-Stem Auger  
 Ground Elevation (ft): Not Measured  
 Drilled By: Holocene Drilling Inc.  
 Logged By: JSN Date: 05/19/20

1490005.01 7/20/20 C:\USERS\MSK\IN\NERIDESKTOP\1490005.010.GPJ SOIL BORING LOG WITH GRAPH

Depth (ft)	Elevation (ft)	Sample Number & Interval	Sampler Type	Blows/Foot	Test Data	Graphic Symbol	USCS Symbol	Soil Profile Description
0							AC	4 inches of asphalt over 3.5 inches of crushed rock base course <b>(ASPHALT)</b>
0 - 1.5		S-1	b2	5	W = 15		ML	Gray-brown SILT with sand and gravel (medium stiff, moist) <b>(PRE-VASHON SILT)</b>
1.5 - 3.0		S-2	b2	4				
3.0 - 4.5		S-3	b2	4	W = 32 AL			-Grades to without sand or gravel -Grades to gray
4.5 - 6.0		S-4	b2	8				
6.0 - 7.5		S-5	b2	4	W = 28			

Groundwater Not Encountered

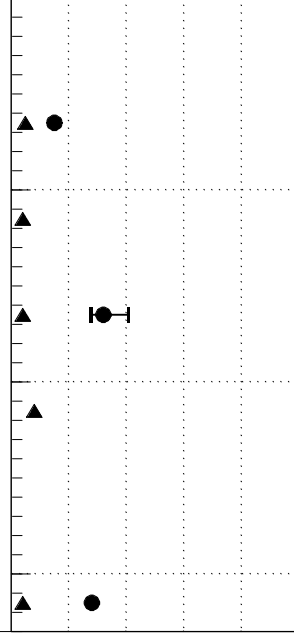

Boring Completed 05/19/20  
 Total Depth of Boring = 16.5 ft.

- Notes:
1. Stratigraphic contacts are based on field interpretations and are approximate.
  2. Reference to the text of this report is necessary for a proper understanding of subsurface conditions.
  3. Refer to "Soil Classification System and Key" figure for explanation of graphics and symbols.



Bangor-Keyport  
 Force Main Replacement  
 Kitsap County, Washington

Log of Boring B-18

Figure  
**A-19**



# B-19

LAI Project No: 1490005.010

## SAMPLE DATA

## SOIL PROFILE

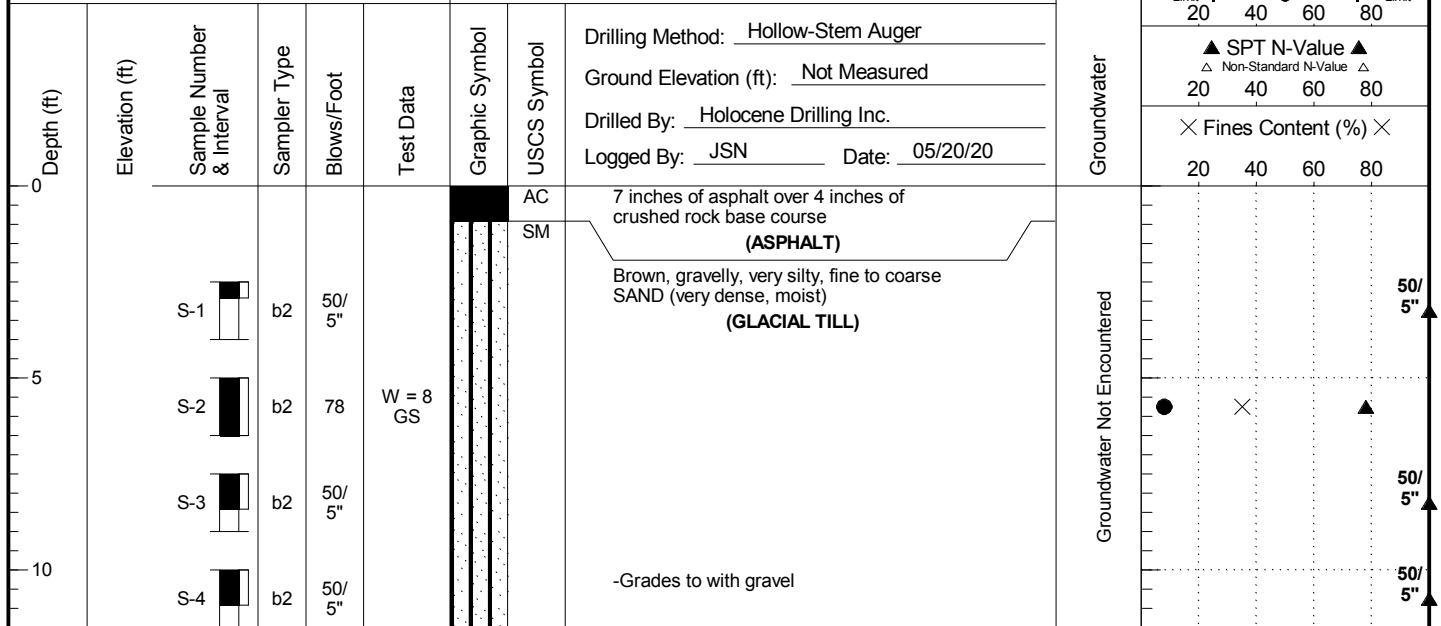

Boring Completed 05/20/20  
Total Depth of Boring = 11.5 ft.

- Notes:
1. Stratigraphic contacts are based on field interpretations and are approximate.
  2. Reference to the text of this report is necessary for a proper understanding of subsurface conditions.
  3. Refer to "Soil Classification System and Key" figure for explanation of graphics and symbols.

1490005.01 7/20/20 C:\USERS\MSK\IN\NER\DESK\TOP\1490005.010.GPJ SOIL BORING LOG WITH GRAPH



Bangor-Keyport  
Force Main Replacement  
Kitsap County, Washington

Log of Boring B-19

Figure  
**A-20**

# B-20

LAI Project No: 1490005.010

## SAMPLE DATA

## SOIL PROFILE

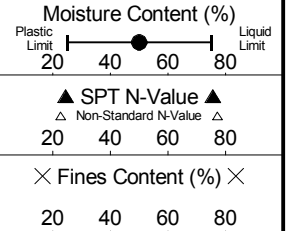

Depth (ft)	Elevation (ft)	Sample Number & Interval	Sampler Type	Blows/Foot	Test Data	Graphic Symbol	USCS Symbol	Soil Profile Description		Groundwater
								Drilling Method: Hollow-Stem Auger	Ground Elevation (ft): Not Measured	
0								4 inches of asphalt over 2 inches of crushed rock base course <b>(ASPHALT)</b>		
0-5		S-1	b2	15	W = 21 GS		AC SM	Brown, very silty, fine SAND (medium dense, moist) <b>(RECESSIONAL OUTWASH)</b>	Groundwater	
5-10		S-2	b2	15				-Grades to with gravel	Groundwater Not Encountered	
10-15		S-3	b2	11	W = 17 -200 = 54		ML	Brown, very sandy SILT (medium stiff, moist)		
15-20		S-4	b2	23				-Grades to gray		
20-25		S-5	b2	18				-Grades to very stiff		
25-30		S-6	b2	18				-Grades to without sand		

Boring Completed 05/20/20  
 Total Depth of Boring = 16.5 ft.

- Notes:
1. Stratigraphic contacts are based on field interpretations and are approximate.
  2. Reference to the text of this report is necessary for a proper understanding of subsurface conditions.
  3. Refer to "Soil Classification System and Key" figure for explanation of graphics and symbols.

1490005.01 7/20/20 C:\USERS\MSK\IN\NERIDESKTOP\1490005.010.GPJ SOIL BORING LOG WITH GRAPH



Bangor-Keyport  
 Force Main Replacement  
 Kitsap County, Washington

Log of Boring B-20

Figure  
**A-21**

# B-21

LAI Project No: 1490005.010

## SAMPLE DATA

## SOIL PROFILE

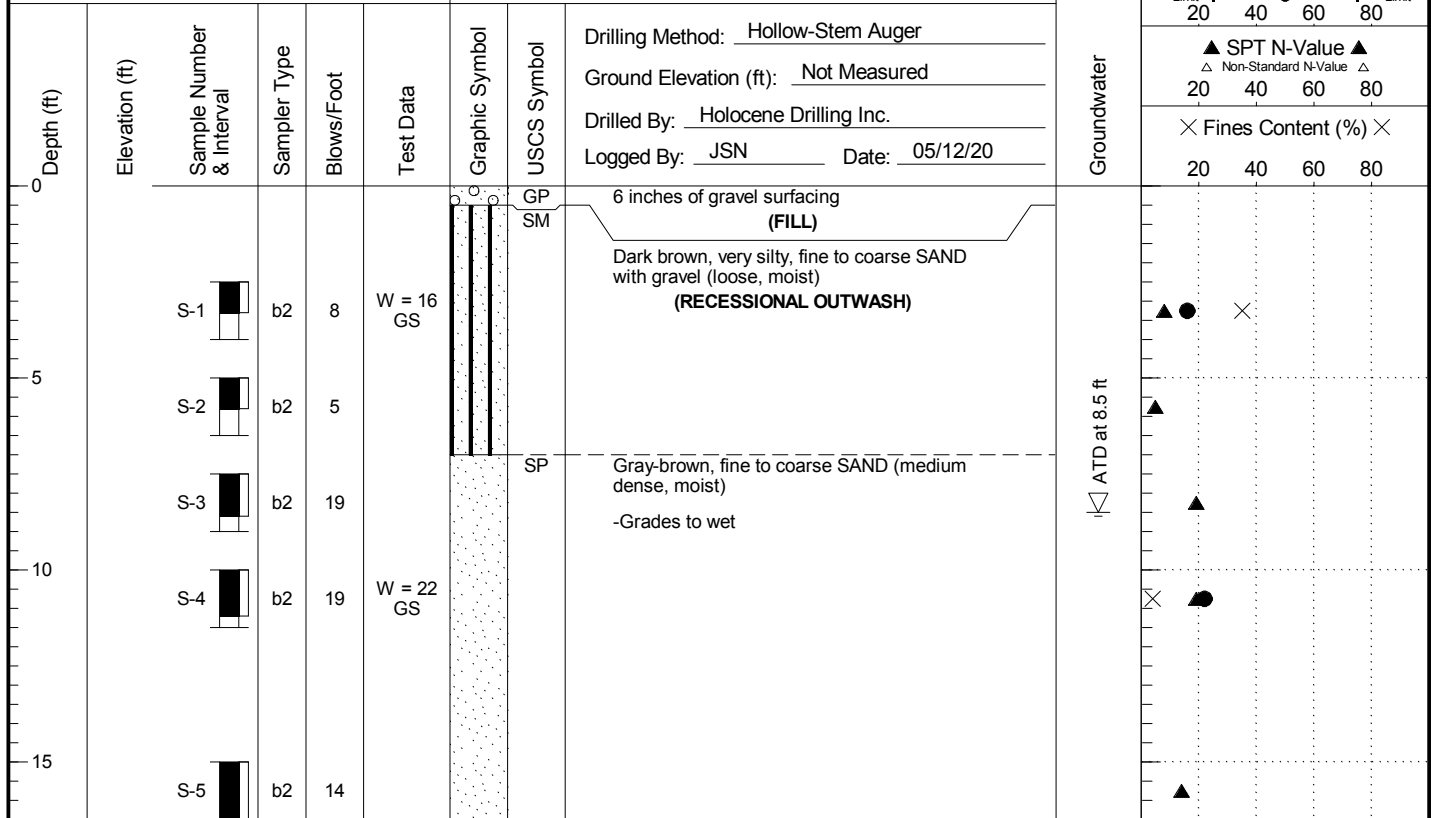

Boring Completed 05/12/20  
Total Depth of Boring = 16.5 ft.

- Notes:
1. Stratigraphic contacts are based on field interpretations and are approximate.
  2. Reference to the text of this report is necessary for a proper understanding of subsurface conditions.
  3. Refer to "Soil Classification System and Key" figure for explanation of graphics and symbols.

1490005.01 7/20/20 C:\USERS\MSK\IN\NERIDESKTOP\1490005.010.GPJ SOIL BORING LOG WITH GRAPH



Bangor-Keyport  
Force Main Replacement  
Kitsap County, Washington

Log of Boring B-21

Figure  
A-22

# B-22

LAI Project No: 1490005.010

## SAMPLE DATA

## SOIL PROFILE

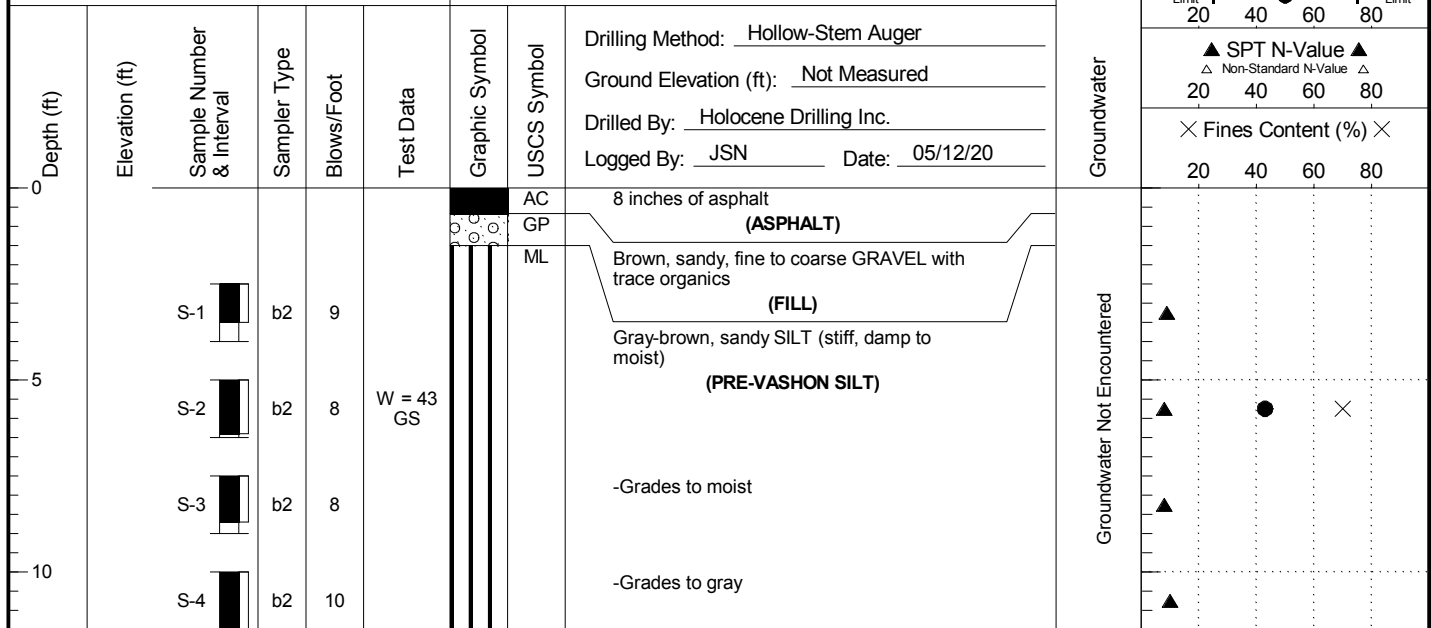

Boring Completed 05/12/20  
Total Depth of Boring = 11.5 ft.

1490005.01 7/20/20 C:\USERS\MSK\IN\NER\DESK\TOP\1490005.010.GPJ SOIL BORING LOG WITH GRAPH

- Notes:
1. Stratigraphic contacts are based on field interpretations and are approximate.
  2. Reference to the text of this report is necessary for a proper understanding of subsurface conditions.
  3. Refer to "Soil Classification System and Key" figure for explanation of graphics and symbols.



Bangor-Keyport  
Force Main Replacement  
Kitsap County, Washington

Log of Boring B-22

Figure  
**A-23**

# B-23

LAI Project No: 1490005.010

## SAMPLE DATA

## SOIL PROFILE

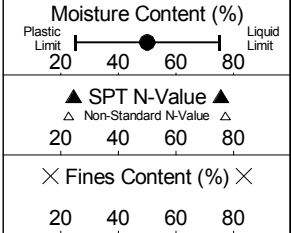

Drilling Method: Hollow-Stem Auger  
 Ground Elevation (ft): Not Measured  
 Drilled By: Holocene Drilling Inc.  
 Logged By: JSN Date: 05/12/20

Depth (ft)  
 0  
 5  
 10  
 15  
 20  
 25  
 30  
 35

Elevation (ft)	Sample Number & Interval	Sampler Type	Blows/Foot	Test Data	Graphic Symbol	USCS Symbol	Description
0					AC		6 inches of asphalt <b>(ASPHALT)</b>
					GP		Brown, sandy, fine to coarse GRAVEL (medium dense, damp) <b>(FILL)</b>
	S-1	b2	14		ML		Gray-brown SILT with sand (stiff, moist) <b>(RECESSIONAL OUTWASH)</b>
	S-2	b2	14	W = 25 -200 = 79			-Grades to gray
	S-3A S-3B	b2	17				-Grades to very stiff
	S-4	b2	18		SP		Gray-brown, fine to coarse SAND (medium dense, moist)
	S-5	b2	30				-Grades to dense

Groundwater  
 Groundwater Not Encountered

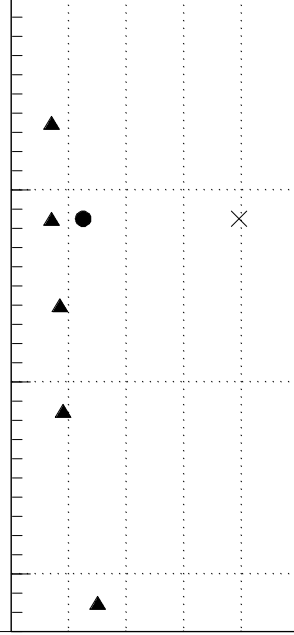

Boring Completed 05/12/20  
 Total Depth of Boring = 16.5 ft.

- Notes:
1. Stratigraphic contacts are based on field interpretations and are approximate.
  2. Reference to the text of this report is necessary for a proper understanding of subsurface conditions.
  3. Refer to "Soil Classification System and Key" figure for explanation of graphics and symbols.

1490005.01 7/20/20 C:\USERS\MSK\IN\NERIDESKTOP\1490005.010.GPJ SOIL BORING LOG WITH GRAPH



Bangor-Keyport  
 Force Main Replacement  
 Kitsap County, Washington

Log of Boring B-23

Figure  
**A-24**

# B-24

LAI Project No: 1490005.010

## SAMPLE DATA

## SOIL PROFILE

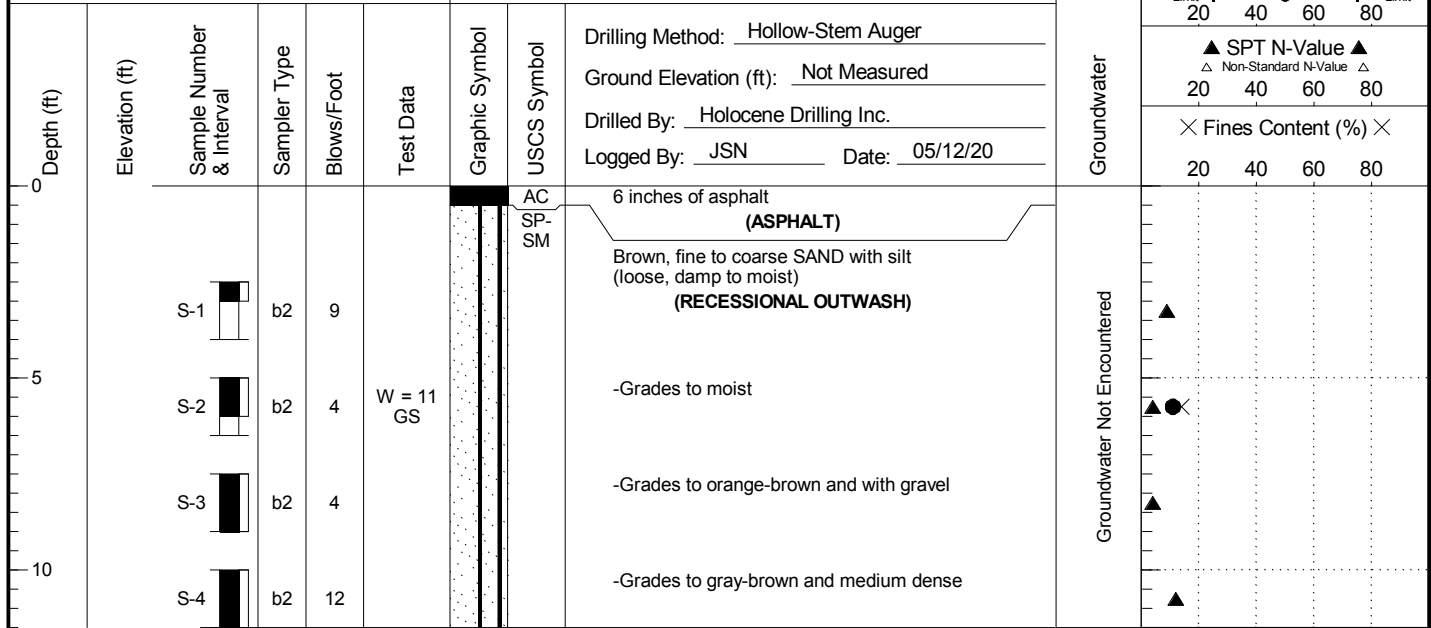

Boring Completed 05/12/20  
Total Depth of Boring = 11.5 ft.

- Notes:
1. Stratigraphic contacts are based on field interpretations and are approximate.
  2. Reference to the text of this report is necessary for a proper understanding of subsurface conditions.
  3. Refer to "Soil Classification System and Key" figure for explanation of graphics and symbols.

1490005.01 7/20/20 C:\USERS\MSK\IN\NERIDESKTOP\1490005.010.GPJ SOIL BORING LOG WITH GRAPH



Bangor-Keyport  
Force Main Replacement  
Kitsap County, Washington

Log of Boring B-24

Figure  
**A-25**

# B-25

LAI Project No: 1490005.010

## SAMPLE DATA

## SOIL PROFILE

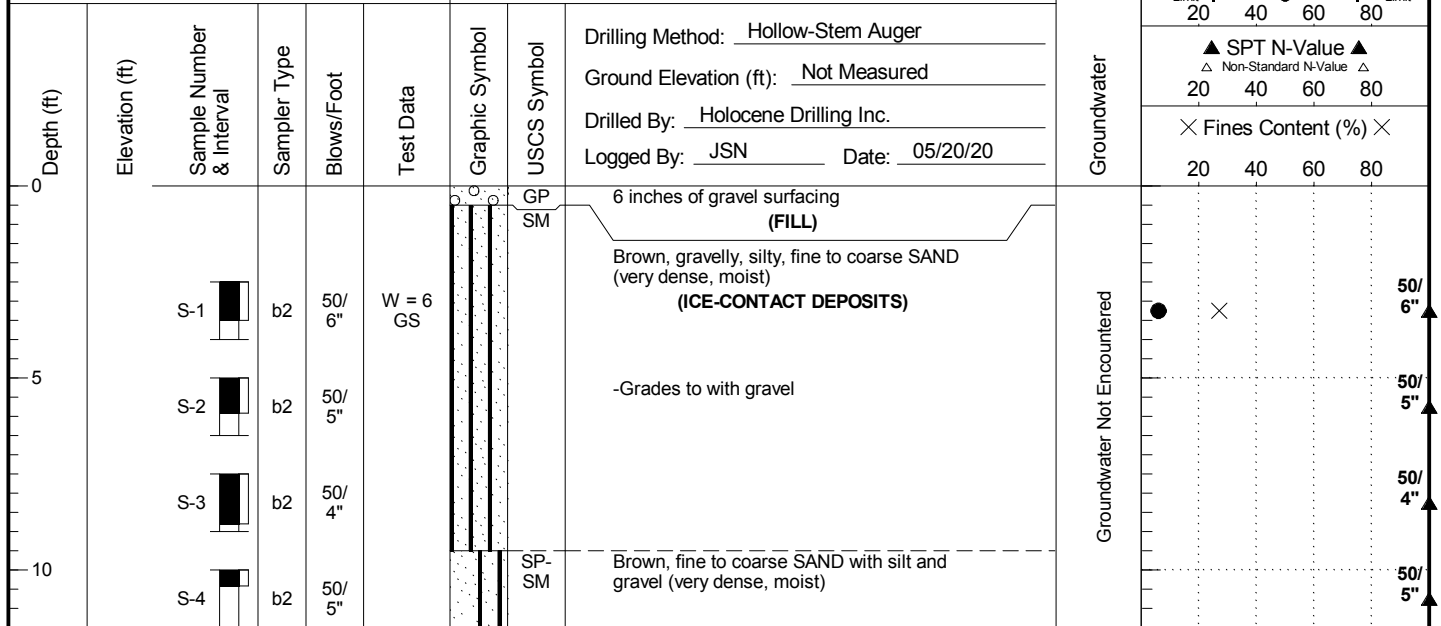

Boring Completed 05/20/20  
Total Depth of Boring = 11.5 ft.

- Notes:
1. Stratigraphic contacts are based on field interpretations and are approximate.
  2. Reference to the text of this report is necessary for a proper understanding of subsurface conditions.
  3. Refer to "Soil Classification System and Key" figure for explanation of graphics and symbols.

1490005.01 7/20/20 C:\USERS\MSK\IN\NER\DESKTOP\1490005.010.GPJ SOIL BORING LOG WITH GRAPH



Bangor-Keyport  
Force Main Replacement  
Kitsap County, Washington

Log of Boring B-25

Figure  
**A-26**

# Laboratory Soil Testing



---

## **APPENDIX B LABORATORY TESTING**

Natural moisture content determinations, grain size analyses, U.S. No. 200 washes, and Atterberg limits tests were performed on select samples to facilitate soil classification. Laboratory testing was performed in general accordance with the ASTM International (ASTM) standard test methods noted below. The samples were checked against the field log descriptions, and the descriptions were updated, where appropriate, in accordance with ASTM standard test method D2487, *Standard Practice for Classification of Soils for Engineering Purposes (Unified Soil Classification System)*.

### **Natural Moisture Content**

Natural moisture content determinations were performed in accordance with ASTM standard test method D2216, *Standard Test Methods for Laboratory Determination of Water (Moisture) Content of Soil and Rock by Mass*. The natural moisture content is shown as W = xx (i.e., percent of dry weight) on the summary logs in Appendix A.

### **Grain Size Analysis**

To provide an indication of the grain size distribution of site soils, sieve analyses were conducted in accordance with ASTM standard test method D422, *Standard Test Method for Particle-Size Analysis of Soils*. Samples selected for grain size analysis are designated with a “GS” on the summary logs in Appendix A. The results of the grain size analyses are presented on Figures B-1 through B-8.

### **U.S. No. 200 Wash**

To assess the amount of fines, select samples were washed over a U.S. No. 200 sieve in accordance with ASTM standard test method C117, *Standard Test Method for Materials Finer Than 75- $\mu$ m (No. 200) Sieve in Mineral Aggregates by Washing*. Samples selected for U.S. No. 200 washes are designated with a “-200 = xx” on the summary logs in Appendix A.

### **Atterberg Limits Tests**

To provide an indication of the plasticity of fine-grained site soils, Atterberg limits tests were performed in accordance with ASTM standard test method D4318, *Standard Test Methods for Liquid Limit, Plastic Limit, and Plasticity Index of Soils*. Samples selected for Atterberg limits tests are designated with an “AL” on the summary logs in Appendix A. The results of the Atterberg limits tests are presented on Figure B-9.

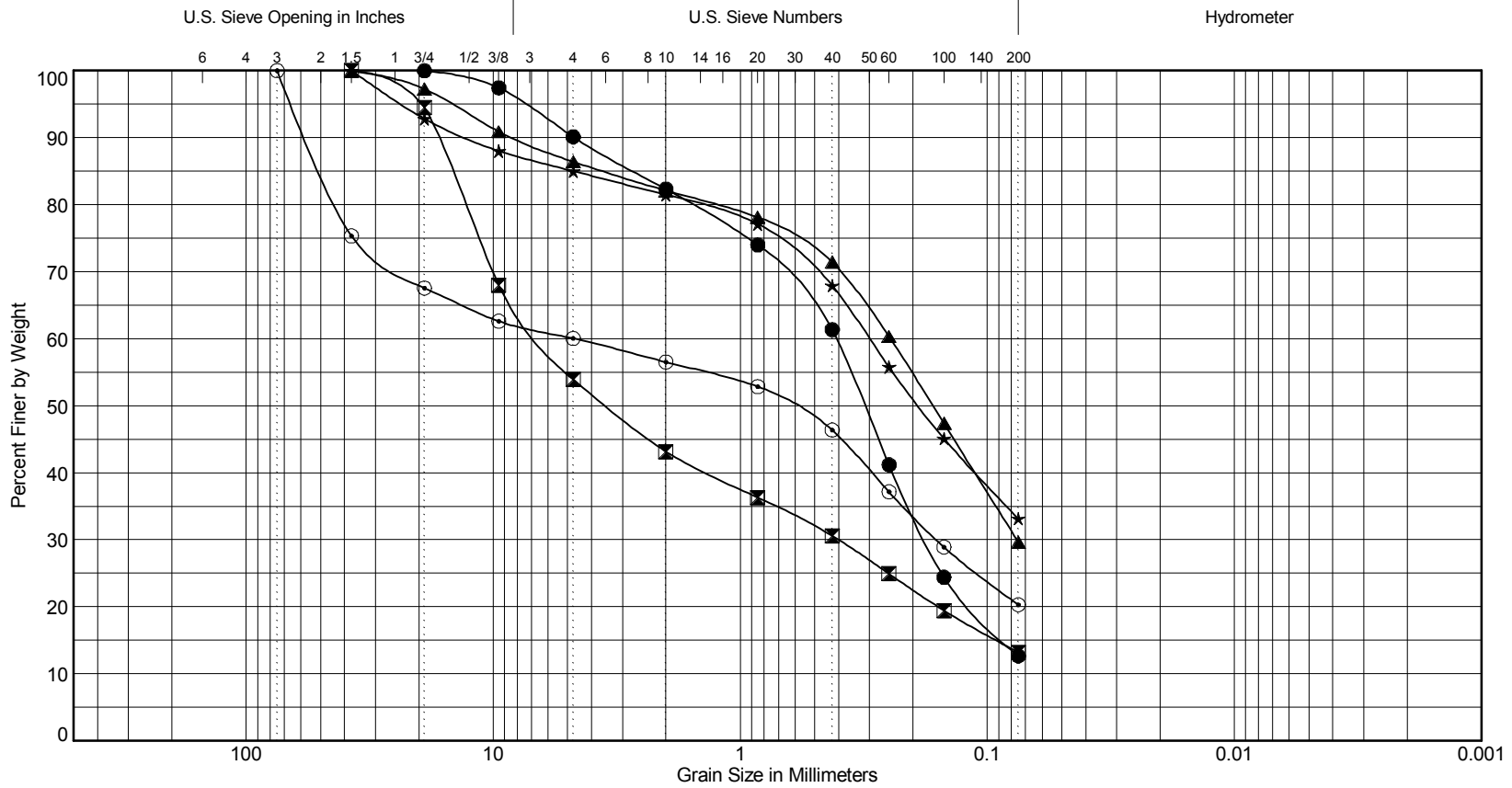

Cobbles	Gravel		Sand			Silt or Clay
	Coarse	Fine	Coarse	Medium	Fine	

Symbol	Exploration Number	Sample Number	Depth (ft)	Natural Moisture (%)	Soil Description	Unified Soil Classification
●	B-1	S-1	2.5	18	Fine to coarse SAND with gravel and silt	SP-SM
⊠	B-4	S-2	5.0	5	Very sandy, fine to coarse GRAVEL with silt	GP-GM
▲	B-5	S-2	5.0	12	Silty, fine to coarse SAND with gravel	SM
★	B-5	S-4	15.0	6	Very silty, fine to coarse SAND with gravel	SM
⊙	B-5	S-5	20.0	5	Silty, very gravelly, fine to coarse SAND	SM

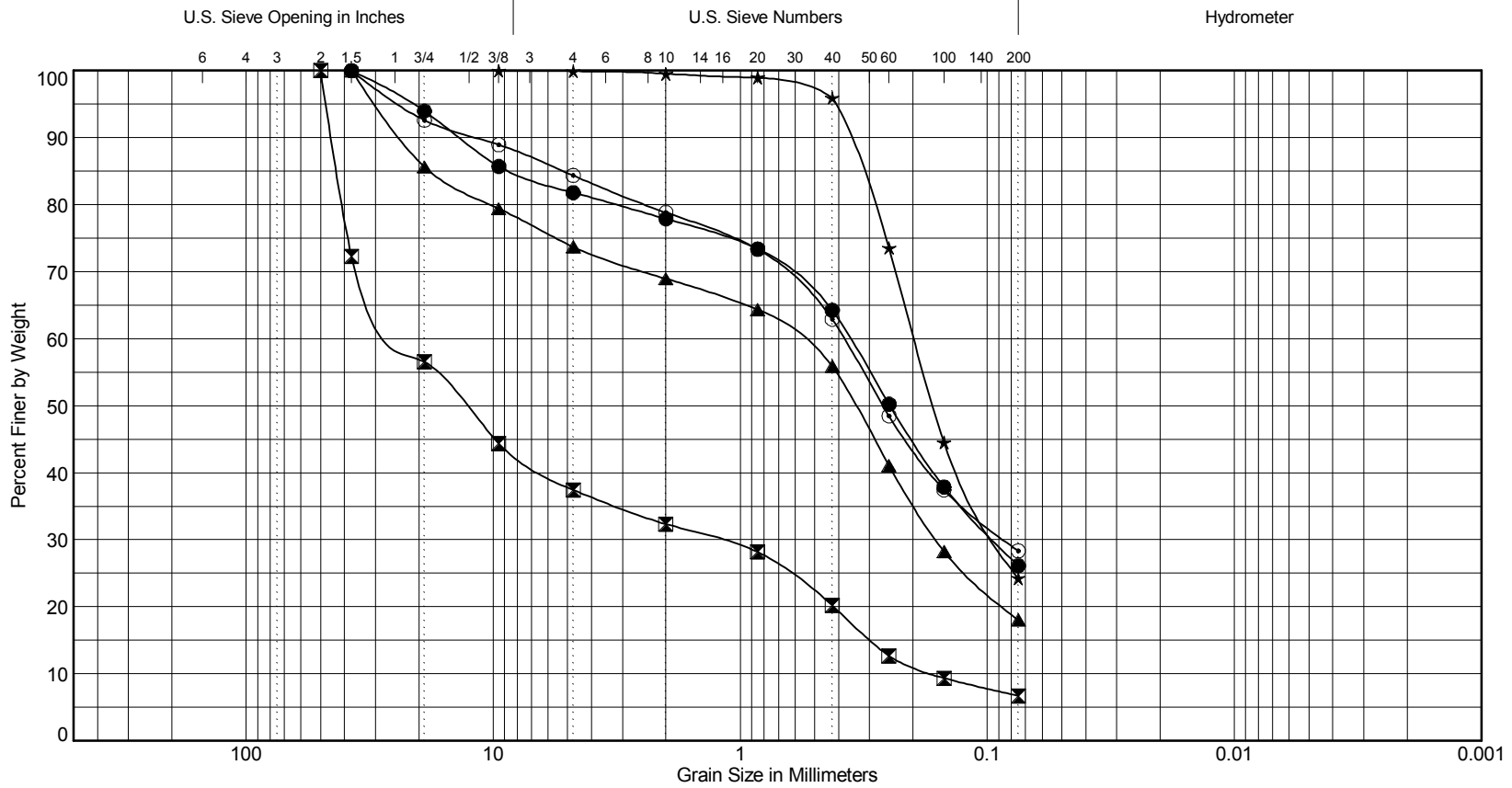

Cobbles	Gravel		Sand			Silt or Clay
	Coarse	Fine	Coarse	Medium	Fine	

Symbol	Exploration Number	Sample Number	Depth (ft)	Natural Moisture (%)	Soil Description	Unified Soil Classification
●	B-5	S-7A	30.0	6	Silty, gravelly, fine to coarse SAND	SM
☒	B-6	S-3	10.0	2	Very sandy, fine to coarse GRAVEL with silt	GP-GM
▲	B-6	S-4	15.0	4	Silty, gravelly, fine to coarse SAND	SM
★	B-6	S-6A	25.0	8	Silty, fine to coarse SAND	SM
⊙	B-6	S-7	30.0	8	Silty, gravelly, fine to coarse SAND	SM

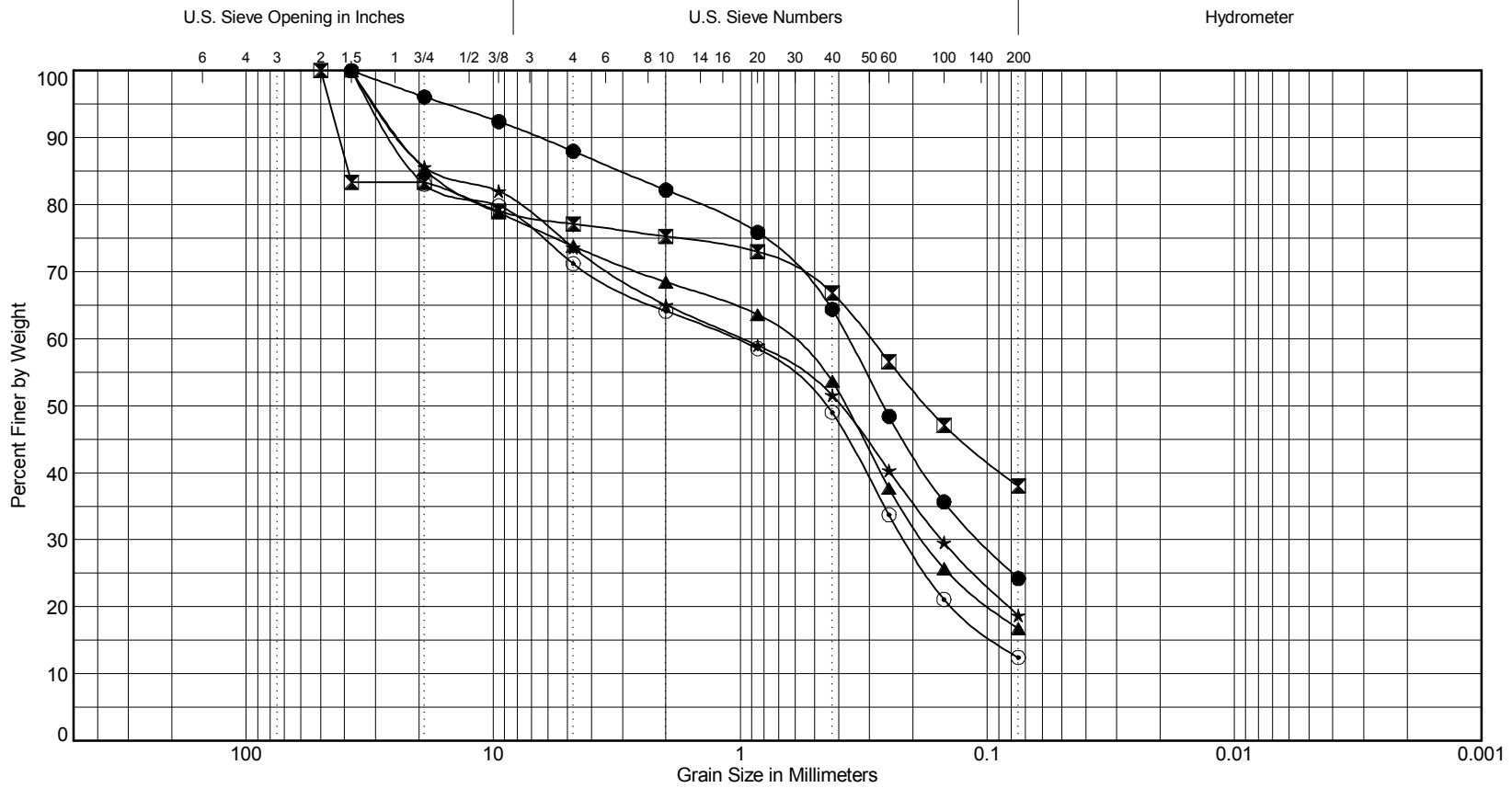

Cobbles	Gravel		Sand			Silt or Clay
	Coarse	Fine	Coarse	Medium	Fine	

Symbol	Exploration Number	Sample Number	Depth (ft)	Natural Moisture (%)	Soil Description	Unified Soil Classification
●	B-6	S-8A	35.0	7	Silty, fine to coarse SAND with gravel	SM
☒	B-6	S-9	40.0	11	Very silty, gravelly, fine to coarse SAND	SM
▲	B-7	S-2A	7.0	5	Silty, gravelly, fine to coarse SAND	SM
★	B-7	S-3	13.0	9	Silty, gravelly, fine to coarse SAND	SM
⊙	B-7	S-4A	16.0	9	Gravelly, fine to coarse SAND with silt	SP-SM

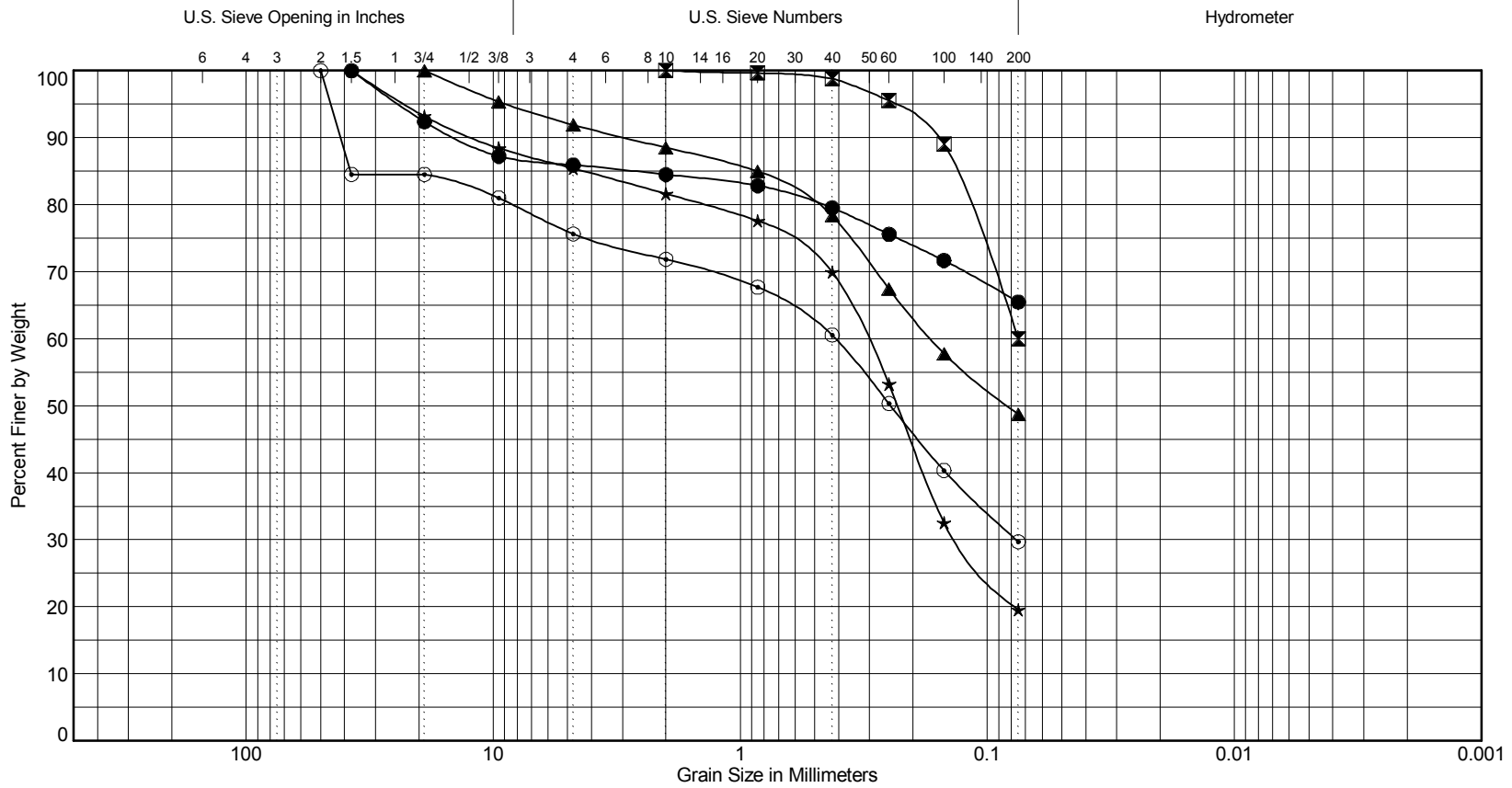

Cobbles	Gravel		Sand			Silt or Clay
	Coarse	Fine	Coarse	Medium	Fine	

Symbol	Exploration Number	Sample Number	Depth (ft)	Natural Moisture (%)	Soil Description	Unified Soil Classification
●	B-7	S-5	22.0	20	Sandy SILT with gravel	ML
⊠	B-7	S-6	27.0	18	Very sandy SILT	ML
▲	B-7	S-8	37.0	10	Very silty, fine to coarse SAND with gravel	SM
★	B-7	S-9	40.0	10	Silty, fine to coarse SAND with gravel	SM
⊙	B-7	S-10	46.0	6	Silty, gravelly, fine to coarse SAND	SM

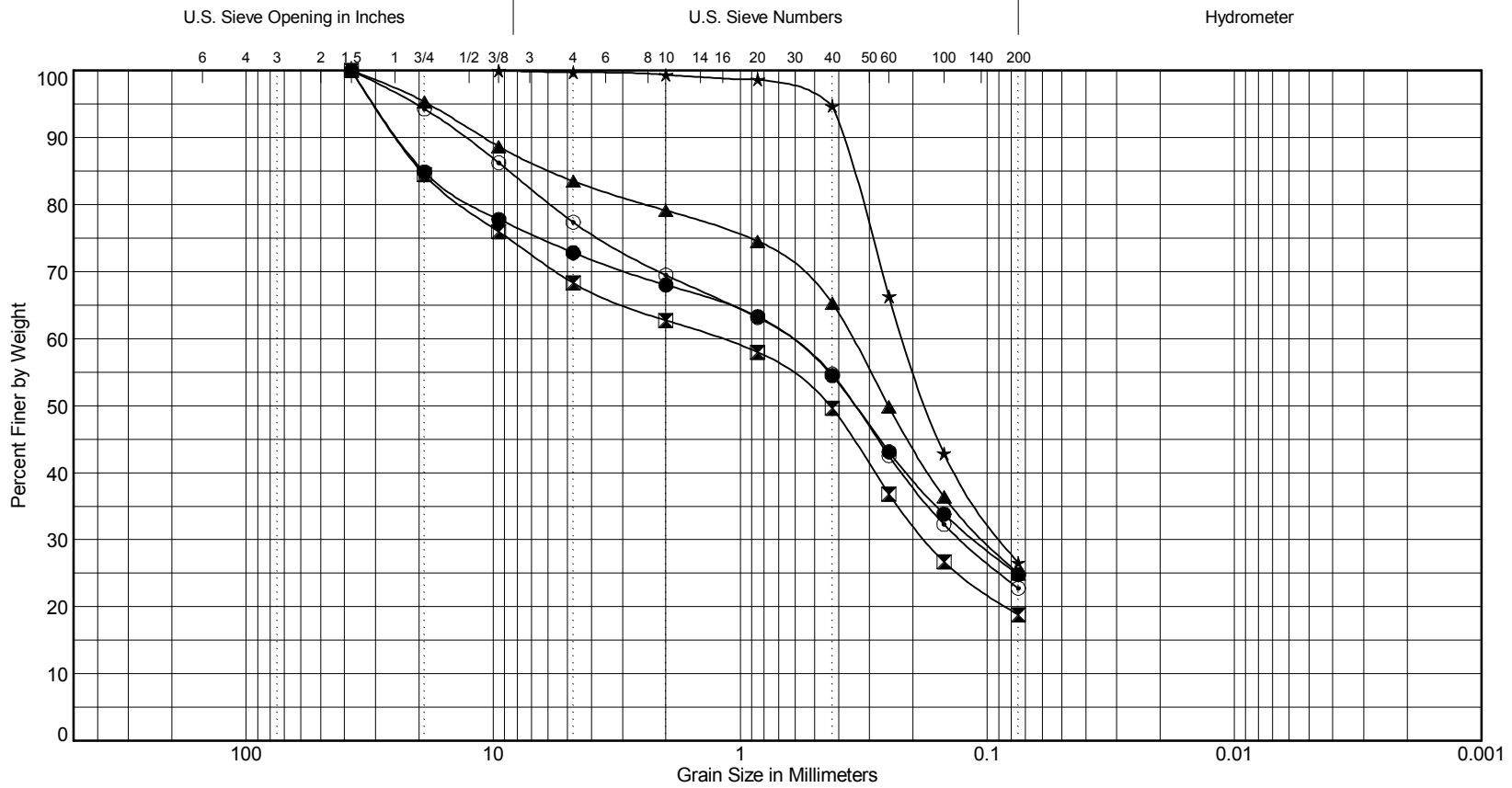

Cobbles	Gravel		Sand			Silt or Clay
	Coarse	Fine	Coarse	Medium	Fine	

Symbol	Exploration Number	Sample Number	Depth (ft)	Natural Moisture (%)	Soil Description	Unified Soil Classification
●	B-8	S-2	7.0	6	Silty, gravelly, fine to coarse SAND	SM
☒	B-8	S-4	17.0	5	Very gravelly, silty, fine to coarse SAND	SM
▲	B-8	S-6	27.5	6	Silty, gravelly, fine to coarse SAND	SM
★	B-8	S-8	38.0	20	Silty, fine to coarse SAND	SM
⊙	B-8	S-10	47.0	5	Silty, gravelly, fine to coarse SAND	SM

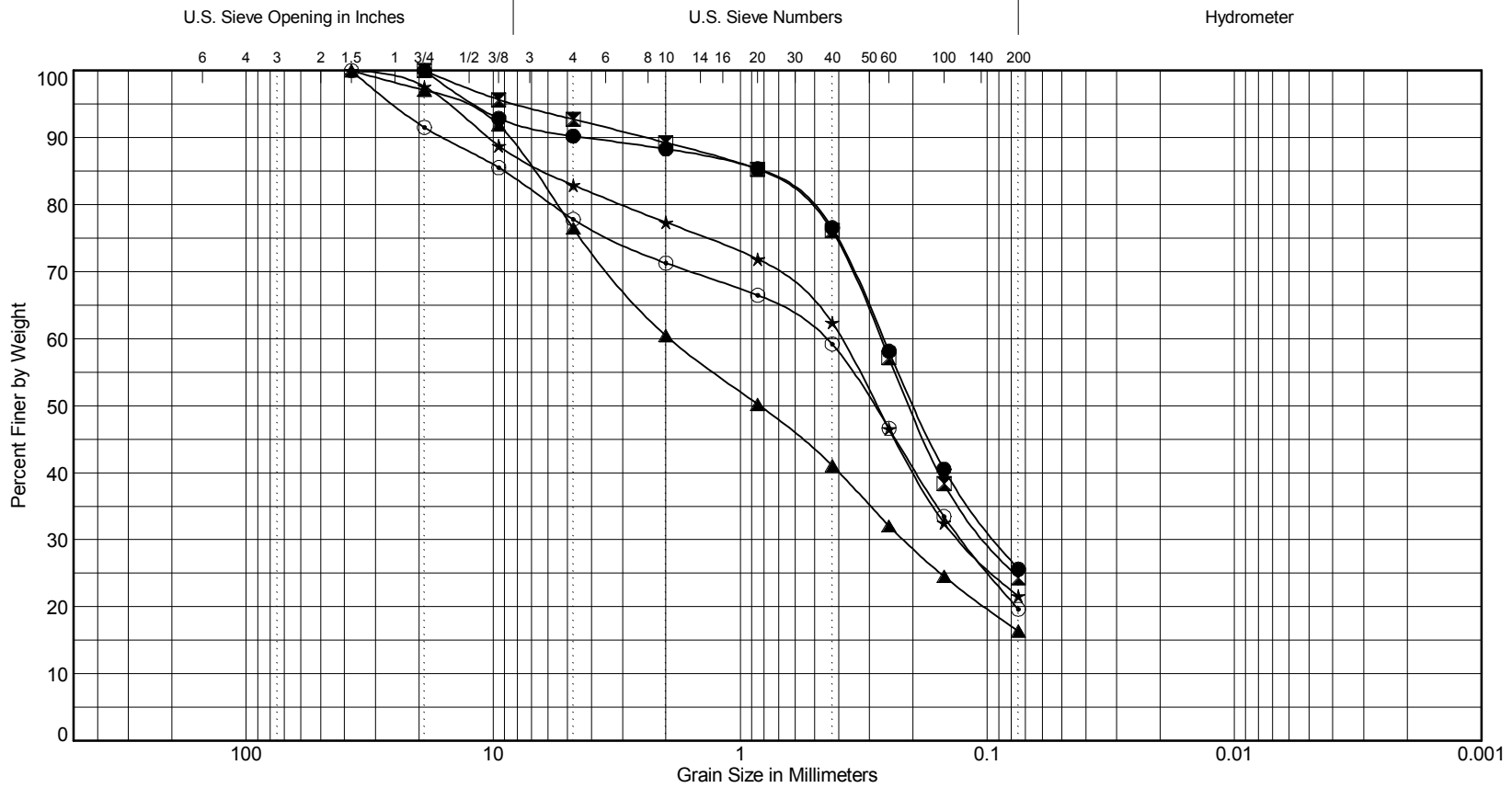

Cobbles	Gravel		Sand			Silt or Clay
	Coarse	Fine	Coarse	Medium	Fine	

Symbol	Exploration Number	Sample Number	Depth (ft)	Natural Moisture (%)	Soil Description	Unified Soil Classification
●	B-12	S-6	20.0	33	Silty, fine to coarse SAND with gravel	SM
⊠	B-13	S-2	5.0	7	Silty, fine to coarse SAND with gravel	SM
▲	B-14	S-1	2.5	6	Silty, gravelly, fine to coarse SAND	SM
★	B-15	S-1	2.5	7	Silty, gravelly, fine to coarse SAND	SM
⊙	B-17	S-1	2.5	8	Silty, gravelly, fine to coarse SAND	SM

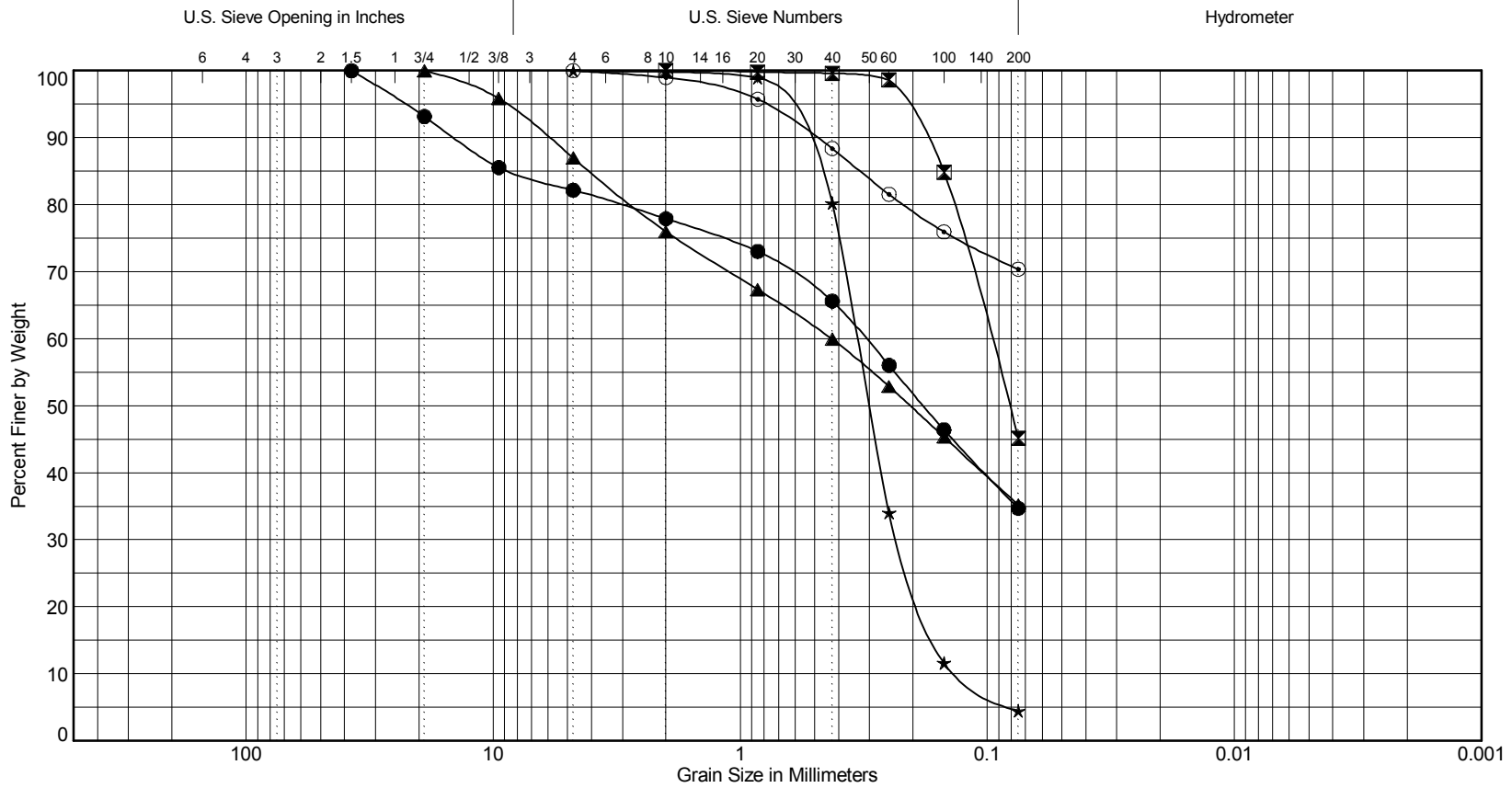



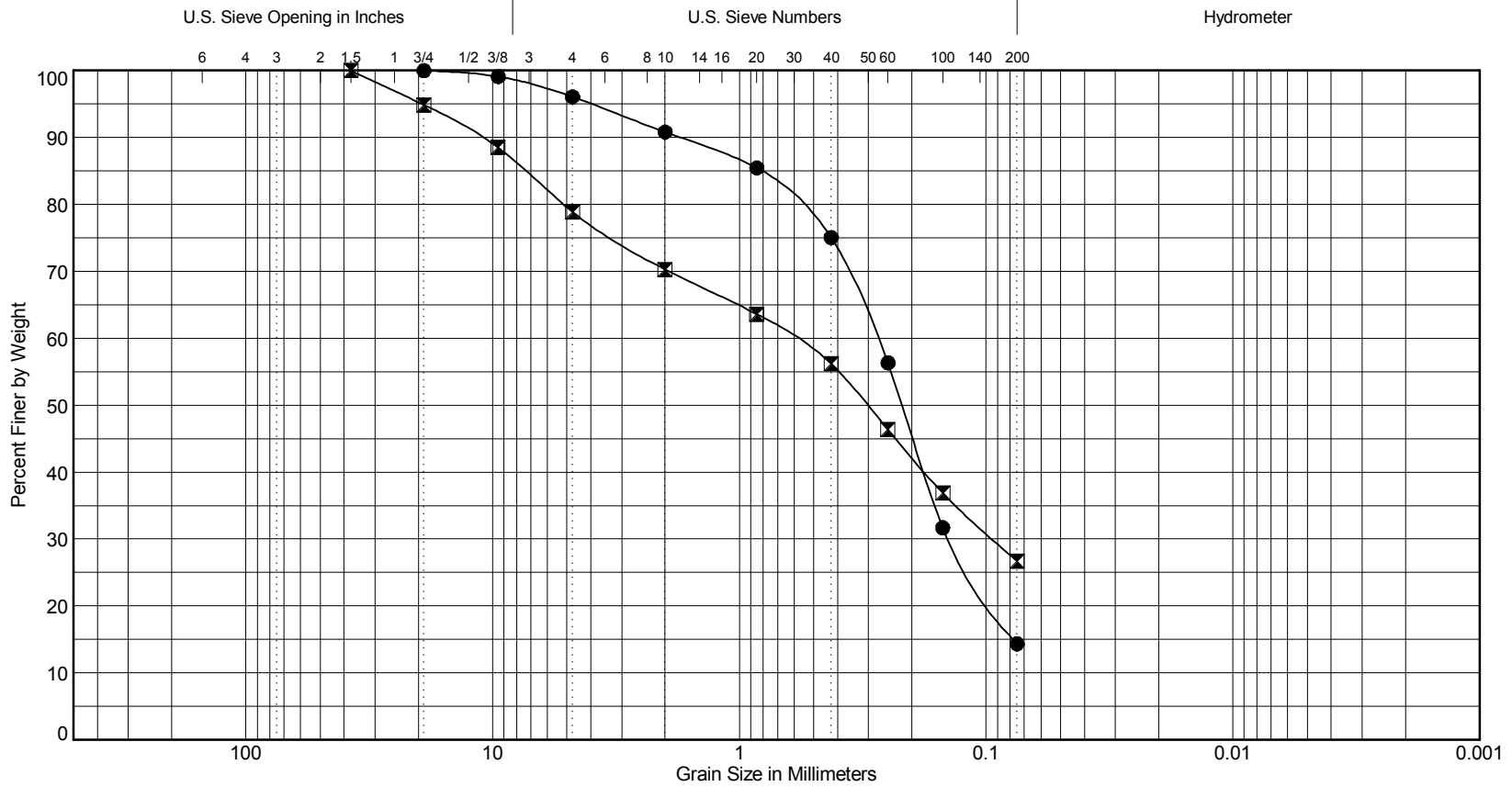

Cobbles	Gravel		Sand			Silt or Clay
	Coarse	Fine	Coarse	Medium	Fine	

Symbol	Exploration Number	Sample Number	Depth (ft)	Natural Moisture (%)	Soil Description	Unified Soil Classification
●	B-24	S-2	5.0	11	Fine to coarse SAND with silt	SP-SM
◩	B-25	S-1	2.5	6	Gravelly, silty, fine to coarse SAND	SM

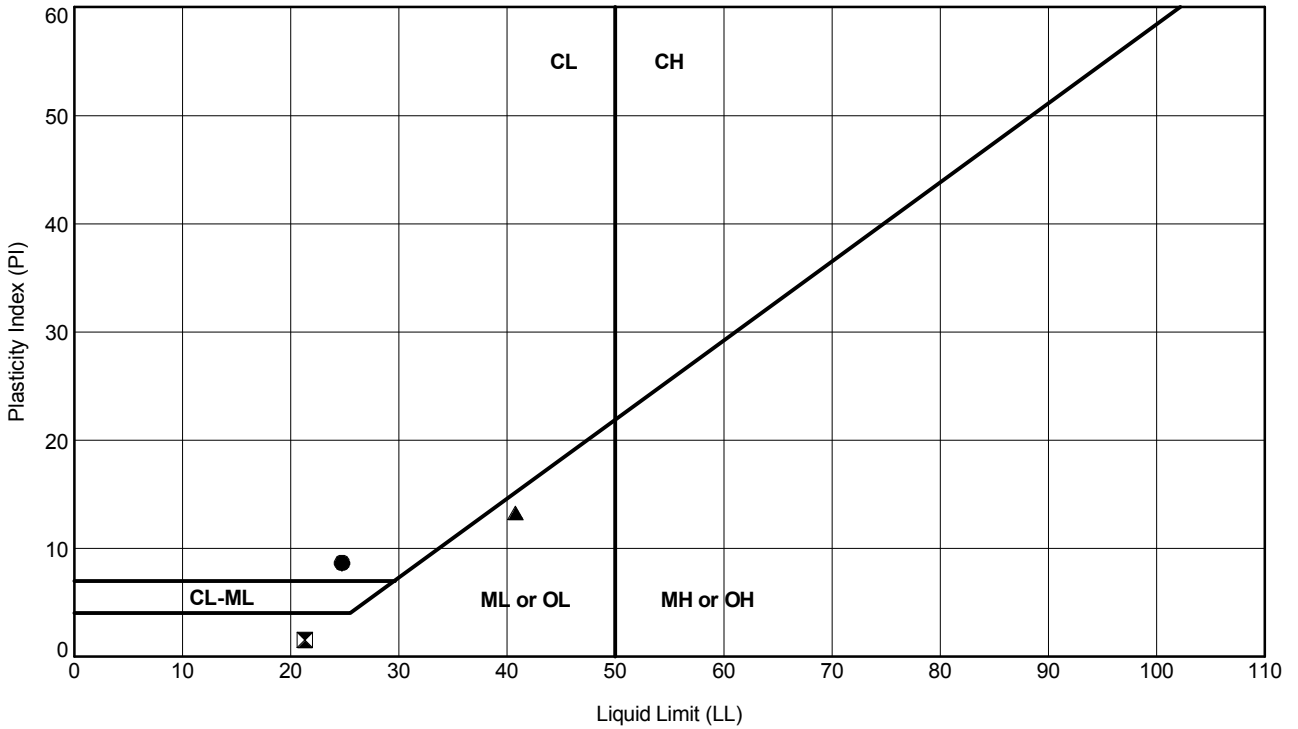

### ATTERBERG LIMIT TEST RESULTS

Symbol	Exploration Number	Sample Number	Depth (ft)	Liquid Limit (%)	Plastic Limit (%)	Plasticity Index (%)	Natural Moisture (%)	Soil Description	Unified Soil Classification
●	B-1	S-4	10.0	25	16	9	22	CLAY	CL
☒	B-17	S-3	7.5	21	20	1	23	SILT	ML
▲	B-18	S-3	7.5	41	28	13	32	SILT	ML

ASTM D 4318 Test Method

# **Photographs of Rotosonic™ Boring Soil Samples**



C:\Users\mskinner\Desktop\Appendix C\_B-5.docx



C:\Users\mskinner\Desktop\Appendix C\_B-5.docx



**B-5, S-5, 20-25 feet**



**B-5, S-6, 25-30 feet**

C:\Users\mskinner\Desktop\Appendix C\_B-5.docx

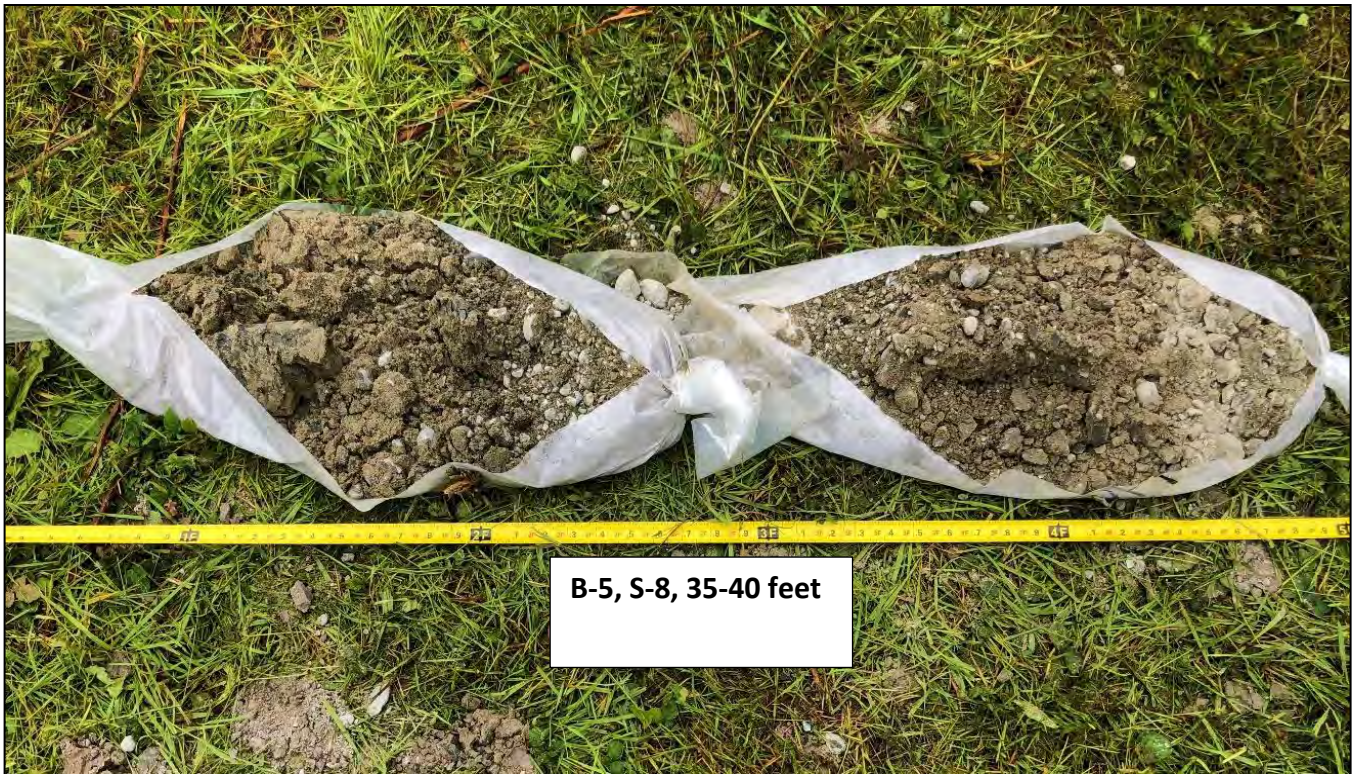

C:\Users\mskinner\Desktop\Appendix C\_B-5.docx



C:\Users\mskinner\Desktop\Appendix C\_B-5.docx





**B-5, S-11, 50-55 feet**



**B-5, S-12, 55-60 feet**

C:\Users\mskinner\Desktop\Appendix C\_B-5.docx



C:\Users\mskinner\Desktop\Appendix C - B-6.docx



**B-6, S-3, 10-15 feet**



**B-6, S-4, 15-20 feet**

C:\Users\mskinner\Desktop\Appendix C\_B-6.docx



C:\Users\mskinner\Desktop\Appendix C\_B-6.docx



C:\Users\mskinner\Desktop\Appendix C\_B-6.docx



**B-6, S-9, 40-45 feet**



**B-6, S-10, 45-50 feet**

C:\Users\mskinner\Desktop\Appendix C\_B-6.docx



C:\Users\mskinner\Desktop\Appendix C\_B-6.docx



**B-7, S-1, 0-5 feet**



**B-7, S-2, 5-10 feet**

C:\Users\mskinner\Desktop\Appendix C\_B-7.docx





**B-7, S-3, 10-15 feet**



**B-7, S-4, 15-20 feet**

C:\Users\mskinner\Desktop\Appendix C\_B-7.docx



**B-7, S-5, 20-25 feet**



**B-7, S-6, 25-30 feet**

C:\Users\mskinner\Desktop\Appendix C\_B-7.docx



**B-7, S-7, 30-35 feet**



**B-7, S-8, 35-40 feet**

C:\Users\mskinner\Desktop\Appendix C\_B-7.docx

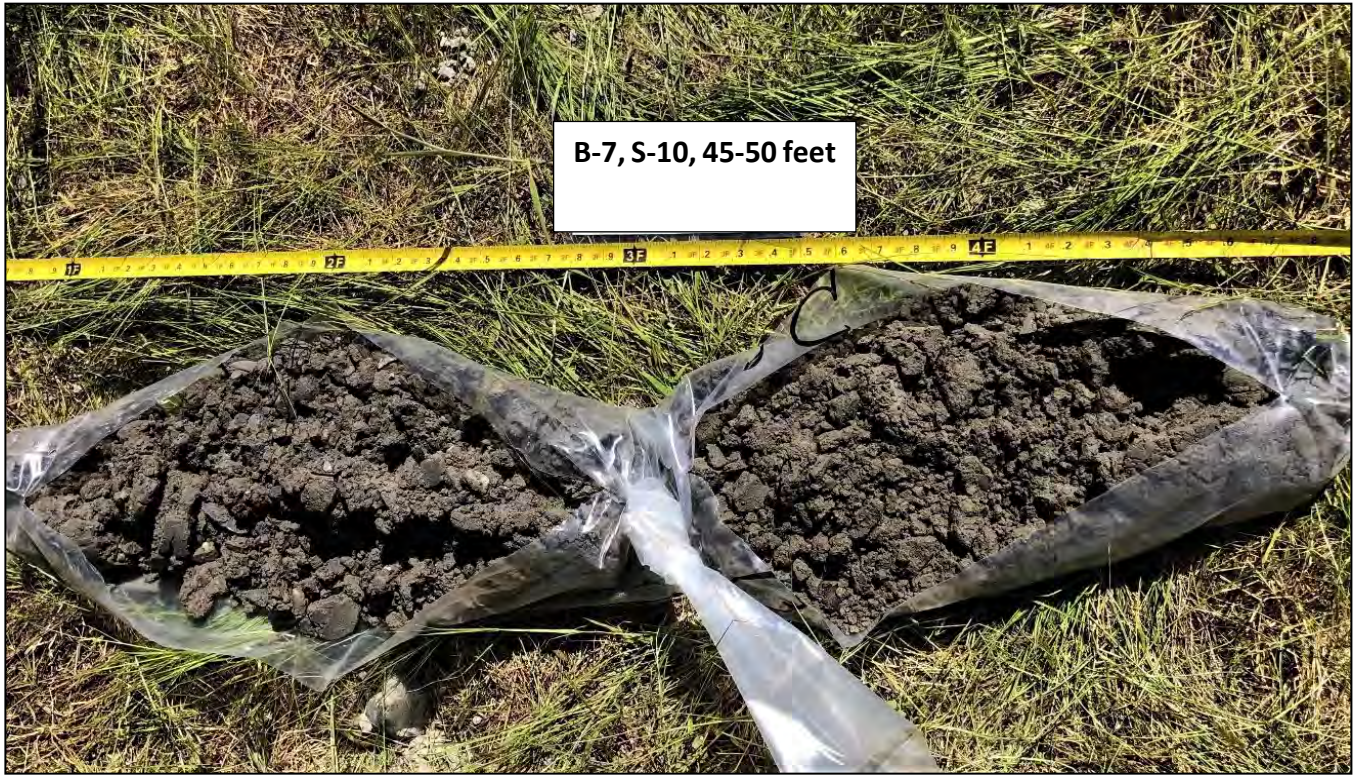

C:\Users\mskinner\Desktop\Appendix C\_B-7.docx



**B-7, S-11, 50-55 feet**



**B-7, S-12, 55-60 feet**

C:\Users\mskinner\Desktop\Appendix C\_B-7.docx



**B-8, S-1, 0-5 feet**



**B-8, S-2, 5-10 feet**

C:\Users\mskinner\Desktop\Appendix C - B-8.docx



C:\Users\mskinner\Desktop\Appendix C\_B-8.docx



C:\Users\miskinner\Desktop\Appendix C - B-8.docx





**B-8, S-7, 30-35 feet**



**B-8, S-8, 35-40 feet**

C:\Users\mskinner\Desktop\Appendix C - B-8.docx



C:\Users\mskinner\Desktop\Appendix C\_B-8.docx



C:\Users\miskinner\Desktop\Appendix C - B-8.docx